



2020 Irrigation Catalog



Eastern Irrigation Supply, Inc.

Ph: 352-472-3323 Fax: 352-472-2830 EIS@irrigationdistributors.com



www.IrrigationDistributors.com



5328 NW State Road 45
Newberry, FL 32669-1089
Phone: 352-472-3323
Fax: 352-472-2830
Email: eis@irrigationdistributors.com

Eastern Irrigation Supply, Inc. - Newberry, FL

Eastern Irrigation Supply, Inc., is a premier irrigation supply center with large and diverse product offering for agriculture, commercial, industrial and residential applications. If your needs include accessories for pump, pipeline, pivot, sideroll, solid set, turf, micro irrigation or traveler replacement parts, there is a good chance that we inventory or have at our disposal the products that will meet your needs.

Presently, EIS represents over 100 of the top manufacturers and suppliers in the industry, whose products we distribute throughout a large portion of the United States, from Puerto Rico to Maine.

Our goal at EIS is to give you the best service possible by having inventory on hand, prompt delivery once an order is received and competitive prices to enhance your position in the market. We also pledge to give technical support if or when you need it.

We genuinely appreciate and thank you for your business.

Where We're Located

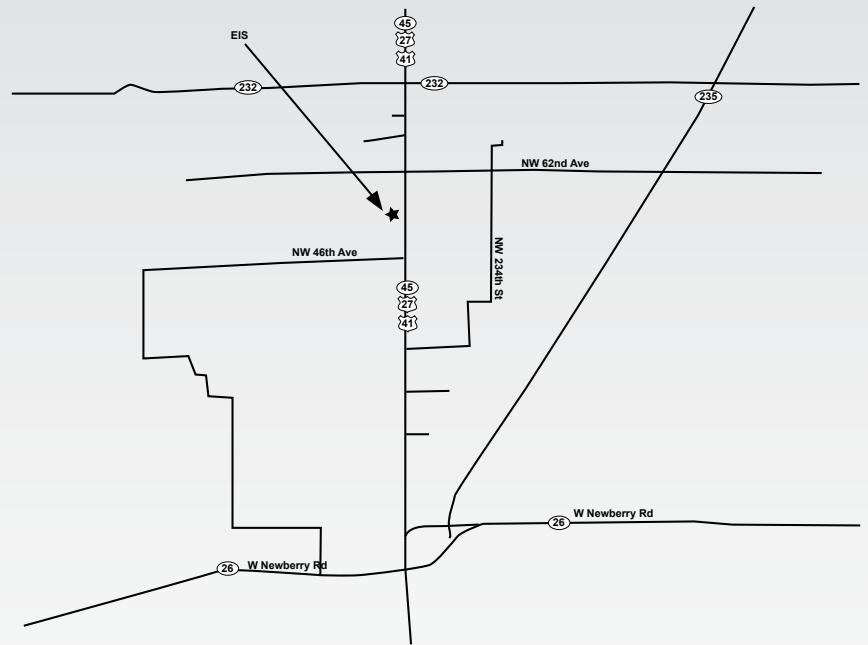

OUR PLEDGE OF SUPPORT & COMMITMENT

Service:

We will provide you with the best service available in the industry. Specializing in same day response to your needs. We will always provide the best and most complete service package available from any supplier.

Quality:

We will always strive to provide you with the highest quality name brand products in the industry, backed with the manufacturer's guarantee and warranty.

Pricing:

We will continually work to provide you with the lowest and most competitive prices in the industry. In many cases, we will be able to extend "factory direct pricing," the same that you would be able to purchase at direct from the manufacturer. In every case, we will provide fair and competitive prices for all of your irrigation needs.

Staffing:

We will provide you with our staff of professionals that you are encouraged to use as an extension of your company. Individually, each of our distribution centers can provide you with our many years of extensive irrigation design and product knowledge. Combine that with the personal attention of our product manufacturers and suppliers and you will have a support staff second to none in the industry, all geared to help you with your customer product needs and to help you grow your business.

Selection:

We will provide you with a one stop shop concept that offers you the most complete product selection from a single source supplier. Save time and money by not making multiple stops or calls for supplies. This increases your productivity and puts your company in a position to quickly and efficiently satisfy your customer's needs, all adding to the profitability of your company.

Support:

We will always maintain the perspective of putting your business needs and concerns at the top level of priority in our business. As a small business operation, we understand the needs of other small businesses and the importance of working together to strengthen and support small business interests, their employees, and the local communities in which they operate.

Commitment:

We are committed to helping you build and grow your business. As you purchase products from us, we will return all profits back into the business, keeping them working for you. Whether it be through maintaining adequate stock levels which make it possible to address your customer's needs, selecting new products for you to offer your customers and grow from, or negotiating better prices from manufacturers to lower your cost, we are committed to you.

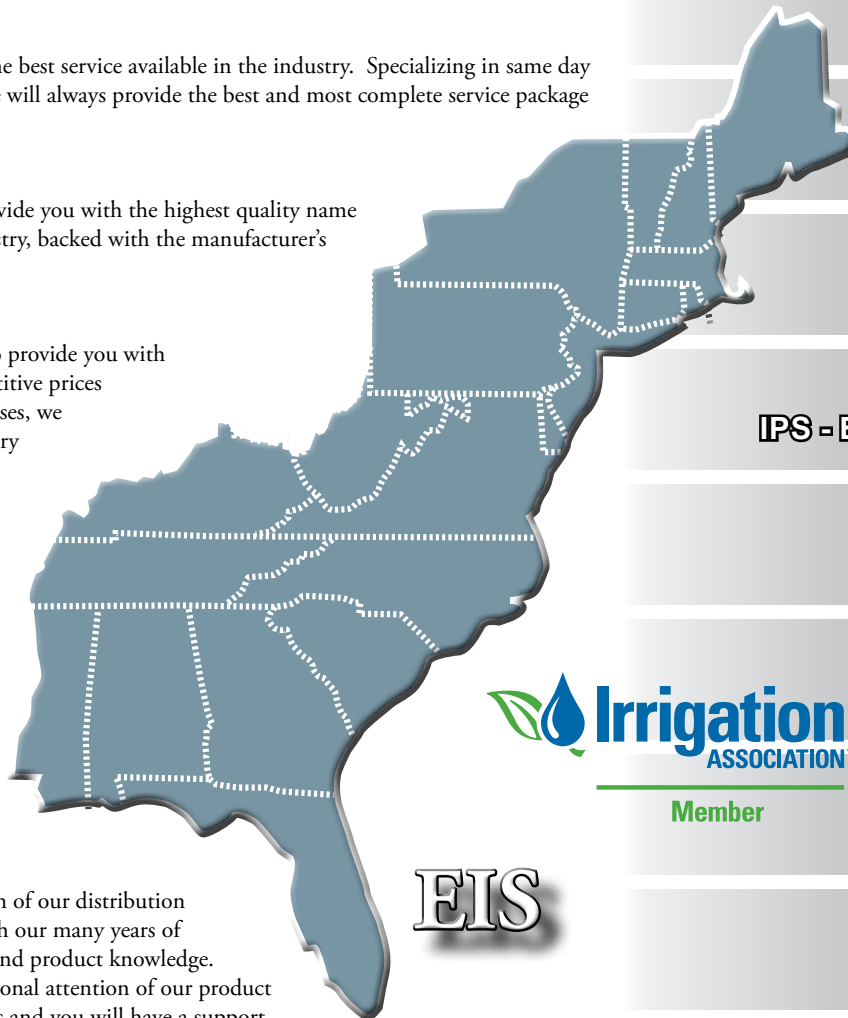

Member

EIS

- SECTION 1 -
PIVOT

- SECTION 2 -
VALVES

- SECTION 3 -
SURFACE

- SECTION 4 -
IPS - EPOXY/GALVANIZED

- SECTION 5 -
SUCTION FITTINGS

- SECTION 6 -
PVC FITTINGS

- SECTION 7 -
SPRINKLERS

- SECTION 8 -
MALLEABLE

- SECTION 9 -
HOSE

- SECTION 10 -
INJECTORS/FILTERS

- SECTION 11 -
LOW VOLUME

FORMULAS &
TABLE OF CONTENTS

We are Your 1 Stop Shop for All Your Irrigation Needs!

Phone: 352-472-3323 - Fax: 352-472-2830 - Email: eis@irrigationdistributors.com

Pivot Section 1

3	SAFETY SWITCHES
4	PRESSURE GAUGES & ACCESSORIES
5	DRAINS
5	DROP VALVES
5	DROP FILTERS
6	UNDERSLING PVC PIPE & ACCESSORIES
7	BOOM BACKS
8	FURROW ARMS & GOOSENECKS
9	DROPS
10	FLEXIBLE DROP HOSE
10	DRAG BULLET & SOCKS
11	HOSE DROP WEIGHTS
12	DROP & CONVERSION FITTINGS
13	FITTINGS & CLAMPS
14-16	SENNINGER PIVOT PRODUCTS
17	RAINBIRD PIVOT PRODUCTS
18-22	NELSON PIVOT PRODUCTS
23-25	NELSON BIG GUN® SPRINKLERS & ACCESSORIES
26-29	CONTROL VALVES & ACCESSORIES
30	END GUN BOOSTER PUMP
30-33	PIVOT DRIVE COMPONENTS
34-35	FUSES
36	TRANSFORMERS, SWITCHES & TIMERS
37	RELAYS
38	CONTACTORS
39	COLLECTOR RING & ELECTRICAL ACCESSORIES
40	STROBE LIGHTS
41	PIVOT BOOT HOSE & T-BOLT CLAMPS
42-43	TIRES, GALVANIZED WHEELS & ASSEMBLIES
44	SERVICE SADDLES
45-46	FLOW METERS



IMPORTANT NOTES:

Prices are subject to change without notice. Please Call us at any time to verify current pricing. Regional Warehouse stocking of all products are subject to 1) manufacturer's policy, 2) regional customer need, and 3) price and availability. Please contact us to verify that specific products are in stock and available for sale in your area.

NOTES

SAFETY SWITCH

EATON / CUTLER-HAMMER - DISCONNECT SWITCH

Rugged indoor/outdoor Nema 3R enclosure protects against the harshest weather.

NON-FUSIBLE DISCONNECTS - 3 Pole, 480VAC / 600VAC / 250VDC

Part No.	Size	Description	Price
DH361URK	30 AMP	Heavy Duty Non-Fused Safety Switch	\$208.16
DH362URK	60 AMP	Heavy Duty Non-Fused Safety Switch	\$393.41
DH363URK	100 AMP	Heavy Duty Non-Fused Safety Switch	\$579.23
DH364URK	200 AMP	Heavy Duty Non-Fused Safety Switch	\$712.68

FUSIBLE DISCONNECTS - 3 Pole, 3 Fuse, 480VAC / 600VAC / 250VDC

Part No.	Size	Description	Price
DH361FRK	30 AMP	Heavy Duty Fused Safety Switch	\$401.92
DH362FRK	60 AMP	Heavy Duty Fused Safety Switch	\$472.58
DH363FRK	100 AMP	Heavy Duty Fused Safety Switch	\$691.36
DH364FRK	200 AMP	Heavy Duty Fused Safety Switch	\$1,055.05
DH365FRK	400 AMP	Heavy Duty Fused Safety Switch	\$2,578.24



Made in the USA
Weather Proof Cabinet
UL Approved

SIEMENS NON-FUSIBLE SAFETY SWITCH

3 Pole, 480VAC / 600VAC / 250VDC

Part No.	Size	Description	Price
HNF361R	30 AMP	Non-Fusible Safety Switch	Call
HNF362R	60 AMP	Non-Fusible Safety Switch	Call
HNF363R	100 AMP	Non-Fusible Safety Switch	Call
HNF364R	200 AMP	Non-Fusible Safety Switch	Call



H = Height, W= Width, D= Depth

LIQUID FILLED PRESSURE GAUGE

2-1/2" FACE, STAINLESS STEEL CASE

Part No.	PSI Range	Price
SEG-201L-254C	0-30	\$13.93
SEG-201L-254D	0-60	\$13.93
SEG-201L-254E	0-100	\$13.93
SEG-201L-254F	0-160	\$13.93
SEG-201L-254G	0-200	\$13.93
SEG-201L-404H	0-300	\$48.00



4" FACE, BLACK ABS PLASTIC CASE

Part No.	PSI Range	Price
SIG-030L	0-30 PSI	\$78.28
SIG-060L	0-60 PSI	\$78.28
SIG-100L	0-100 PSI	\$78.28
SIG-160L	0-160 PSI	\$78.28



PRESSURE GAUGE ACCESSORIES

ACCESSORIES

Part No.	Description	Price
PIT25	Pitot Tube	\$14.03
A90917	Pitot Tube	\$23.06
A90952	Silcock Adapter	\$7.74
12070006	Lock on Gauge Chuck 1/4" FIPT	\$26.79
12070010	Pocket Pressure Gauge 0-50 PSI	\$22.97
9438-002	Fem. Quick Connect 1/4" FIPT	\$44.00
9498	Male Quick Connect 1/4" FIPT	\$22.03
EGA	End Gauge Assembly (Tee, Ell, Bushing, Nipple)	Call
PGW2430F	Polyweight® Gauge 24" 0-30 PSI	Call
PGW2460F	Polyweight® Gauge 24" 0-60 PSI	Call



NELSON SQUARE THREAD GAUGE ADAPTER

Part No.	Description	Price
10766	Square Thread Gauge Adapter (Pressure Gauge Not Included)	\$21.52



DRAINS

PIVOT - DRAIN

Part No.	Size	Description	Price
495-15	3/4"	Mushroom Pivot Drain Knobby Fast Drain	\$1.81
495-25	3/4"	Mushroom Pivot Drain Plain Slow Drain	\$1.81



PIVOT - DRAIN

Fast draining - automatic operation - corrosion & clog resistant

Part No.	Size	Description	Price
TR-18-1	1"	Zamac Poppet	\$9.84
SDMBC-1	1"	Pivot Star Drain Complete w/Metal Base - ZAMAC	\$11.40
SDPBC-1	1"	Pivot Star Drain Complete w/Plastic Base	\$11.40
TR-3/4"DRAIN	1"	PVC Poppet	\$20.59



DROP VALVES & END FLUSH KIT

PIVOT DROP VALVES - 3/4" FIPT X 3/4" MIPT

Part No.	Description	Features	Price
SW-AM-901	901 Orange Handle - Black Body	Quality	\$5.70
FTV3F3M	Blue Knob	Dial Knob	\$6.98



SUPER FLUSH KIT

Hose Length	Hose Type	Matco Brass	Spears Pl. Single Entry	Banjo Pl. Std. Port	Banjo Pl. Full Port
8'	VINYLFLOW™	Call	Call	Call	Call
8'	IRONSIDES™	Call	Call	Call	Call
8'	CLEAR SUCTION	Call	Call	Call	Call
8'	RUBBER	Call	Call	Call	Call
9'	VINYLFLOW™	Call	Call	Call	Call
9'	IRONSIDES™	Call	Call	Call	Call
9'	CLEAR SUCTION	Call	Call	Call	Call
9'	RUBBER	Call	Call	Call	Call
10'	VINYLFLOW™	Call	Call	Call	Call
10'	IRONSIDES™	Call	Call	Call	Call
10'	CLEAR SUCTION	Call	Call	Call	Call
10'	RUBBER	Call	Call	Call	Call



The Super Flush Kit assembly is as simple as 1-2-3 for your pivot flush requirements.

- (1) select the hose length that best suits your needs.
- (2) select the type of hose that you want to use.
- (3) select the proper ball valve for your application.

The kit includes a galvanized 90° street ell, a galvanized king nipple, a plastic insert male adapter, 2 clamps, hose and ball valve.

Note: Other lengths are available upon request. Please specify length when placing order.

DROP FILTERS

3/4" AQUA-DROP FILTER

Threads into bottom of pivot drop for easy access.

Screen sized to reduce and / or prevent nozzles from clogging with debris.

Part No.	Description	Price
ADF075FF	3/4" Aqua-Drop Filter FIPT x FIPT	\$5.18
ADF075FM	3/4" Aqua-Drop Filter FIPT x MIPT	\$5.18
ADF075MF	3/4" Aqua-Drop Filter MIPT x FIPT	\$5.18
ADF075MM	3/4" Aqua-Drop Filter MIPT x MIPT	\$5.18

Screen Features:

- 20 mesh screen - 1/64th inch smaller than smallest nozzle available
- 5 inch screen increases surface area to reduce cleaning frequency
- 304 stainless steel screen for long life & rugged use

Positive seal - gasket is molded into screen & sealed between fittings



3/4" EXCLUDER FILTER

Plug into the inlet side of the gooseneck prior to screwing gooseneck into pivot mainline.

Developed to prevent debris from plugging nozzles.

Part No.	Size	Description	Price
EXC34	3/4"	Insert Filter for Galvanized Gooseneck	\$2.56
EXC58	5/8"	Insert Filter for PVC Gooseneck	\$2.56



UNDERSLING PVC PIPE & ACCESSORIES

CONNECTIONS FROM PIVOT ELL TO PVC PIPE

Part No.	Connection from Pivot Ell to PVC Pipe:	Price
SWE-600-45	6" x 45° Black Steel Weld Elbow	\$70.40
HOSEBEAD-6	6" Black Steel Weld-on Hose Bead	\$22.45
T253AA600XFT	6" Rubber Discharge Hose	\$21.23
95130-0650	T Bolt Clamp (6.25" - 6.65") (4 required)	\$10.43
SGFLEHB-600-45	6" Flanged x Hose Barb 45° Ell, Galvanized	\$181.32
12090023	VBK-1 Air and Vacuum Relief Valve	\$14.21
CO-APR-611	6" x 1/8" Red Rubber Gasket	\$5.34
854-060	6" IPS Van Stone PVC Flange (If Using 6" IPS, 8" IPS or PIP Pipe)	\$50.27
NBS3/4X3	3/4" x 3" Bolt Set	Call
Note: If 8" UV Pipe is used, use products from above table and the products listed below to convert to 8"		
32.602XFT	6-5/8" x 1 Ft. PVC PIPE - 160 PSI	Call
437-585	8" x 6" Sch. 40 Bushing Spig x Soc	\$64.56
429-080	8" Sch. 40 Coupler - Soc	\$33.93
431-080	8" Sch. 40 PIP x IPS Bushing (If Using 8" PIP Pipe)	\$16.74
UV Resistant PVC PIPE	Call For Quote and Availability	Call



SUPPORT HANGERS

Part No.	Support Hangers for PVC Pipe 4", 5", 5-9/16", 6", 6-5/8"	Price
PH-BS-4-65/8	Band and Strap Complete Specify Size & Strap Length	Call
PH-PB-4-65/8	Band Only (2 Required) Specify Pipe Size	Call

Part No.	Support Hangers for PVC Pipe 8", 8-5/8"	Price
PH-BS-8-85-8	Band and Strap Complete Specify Size & Strap Length	Call
PH-PB-8-85-8	Band Only (2 Required) Specify Pipe Size	Call

Part No.	Support Hangers for PVC Pipe	Price
PH-STRAP	15", 16", 18", 20" Strap Only	Call
HBGR-5-1-1/4	1/4" x 1" Bolt	Call
NLN1/4	1/4" Lock Nut	Call
10291-00145	Plumbers Tape 3/4" x 10' x 16 Gauge	Call
532GC7	5/32" Galvanized Aircraft Cable (5000')	Call
AS532	5/32" Aluminum Swage Sleeve (100PK)	Call



OUTLET ADAPTERS & ACCESSORIES

Part No.	Outlet Adapters and Holesaws	Price
TA-050	1/2" FIPT Vinyl Grommet Adapter (use HSA-100)	Call
TA-075	3/4" FIPT Vinyl Grommet Adapter (use HSA-1316)	Call
TA-100	1" FIPT Vinyl Grommet Adapter (use HSA-1716)	Call
HAS-100	1" Hole Saw with Arbor	Call
HAS-1316	1-3/16" Hole Saw with Arbor	Call
HAS-1716	1-7/16" Hole Saw with Arbor	Call
LA-OUT-ADAP	3/4" Barb x 3/4" Barb Outlet Adapter	Call
LA-OUT-CLP	Mainline Pipe Clamp	Call
12070071	Drill Bit for Saddles	Call
12080052	AS-3/4-4 3/4" Socket Bondable Saddle - 4" PVC Pipe	\$1.35
12080054	AS-3/4-6 3/4" Socket Bondable Saddle - 6" PVC Pipe	\$1.35
12080055	AS-3/4-8 3/4" Socket Bondable Saddle - 8" PVC Pipe	\$1.35
461-007	3/4" Spig Adapter for Saddle x 3/4" MPT	\$0.57
478-007	3/4" Spig Adapter for Saddle x 3/4" FPT	\$0.47
460-007	3/4" Spig Adapter for Saddle x 3/4" Barb	\$1.46



Note: 40 PSI Maximum for Vinyl Grommet Adapters and Bondable Saddles
Use Heavy Bodied Cement 719 or Equivalent for Bondable Saddle

HITCHCOCK ADJUSTABLE BOOM BACK

Extends nozzle behind main structure to help prevent deep wheel tracks.

- Lengths of 12 foot or 16 foot are available
- Can use any type of nozzles
- Different angle adjustment
- Easy installation
- Clamps to any size pipe
- Can be used on any type of system

Part No.	Description	Price
H-####	4", 5", 5-9/16", 6", 6-5/8", 8", 8-5/8"	Call

Specify Size, Price is for 12 Ft.

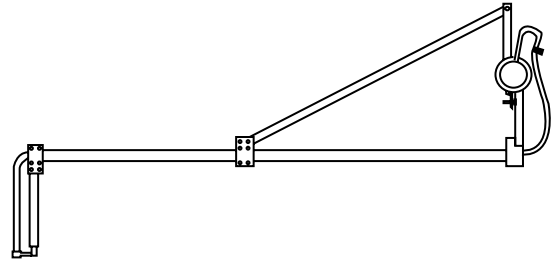

BOOM BACKS

Part No.	Description	Price
BB-4	4" Boom Back	Call
BB-5-9/16	5-9/16" Boom Back	Call
BB-6	6" Boom Back	Call
BB-6-5/8	6-5/8" Boom Back	Call
BB-8	8" Boom Back	Call
BB-8-5/8	8-5/8" Boom Back	Call

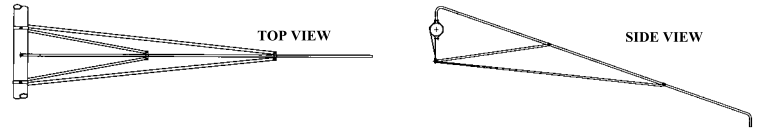

PIVOT CIRCLE STRETCHER

Part No.	Description	Price
CS-0500	5" Circle Stretcher	Call
CS-5916	5-9/16" Circle Stretcher	Call
CS-0600	6" Circle Stretcher	Call
CS-0658	6-5/8" Circle Stretcher	Call

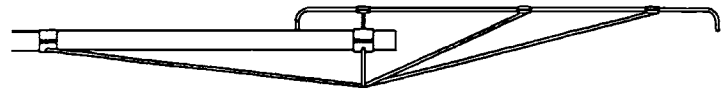

BULLY BOOM SUPPORT ASSEMBLY

Part No.	Description	Price
10BB36-BTS w/Sway	10' Boom Sch. 40, 36" Support	Call
15BB56-BTS w/Sway	15' Boom Sch. 40, 56" Support	Call
10BB30-BTS	10' Boom Sch. 40, 30" Support	Call
15BB56-BTS	15' Boom Sch. 40, 56" Support	Call

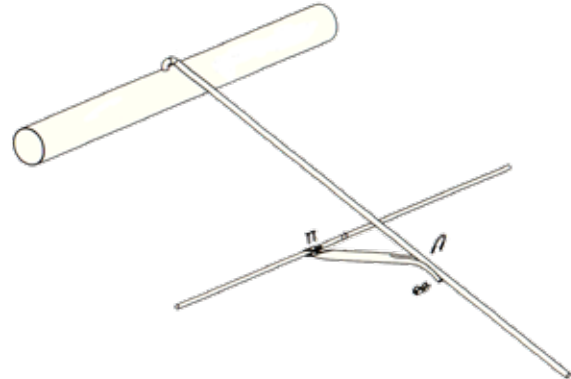

IACO IDAHO BOOM WITH BRACE

Part No.	Description	Price
MST-IOB-A##	10', 3" Through 6-5/8"	Call
MST-IOB-A##	10', 8" Through 10"	Call
MST-IOB-C##	15', 3" Through 6-5/8"	Call
MST-IOB-C##	15', 8" Through 10"	Call

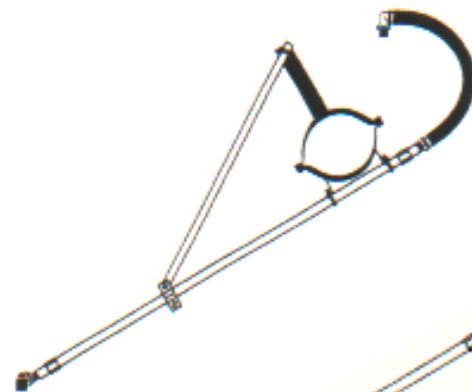

IACO ALUMA BOOM WITH BRACE

Part No.	Description	Price
MAL-IOB-C15	5-9/16" x 15'	Call
MAL-IOB-C17	6-5/8" x 15'	Call
MAL-IOB-C18	8" x 15'	Call

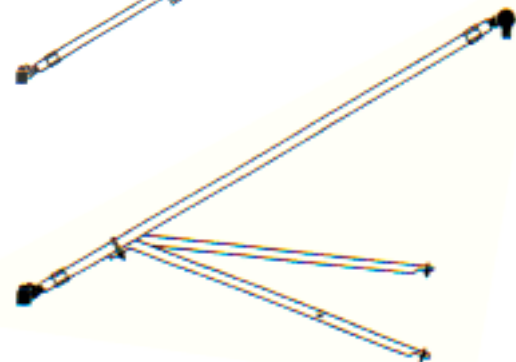

IACO BOOM WITH BRACE

Part No.	Description	Price
MST-BBT-V20	10' Boom with Brace	Call

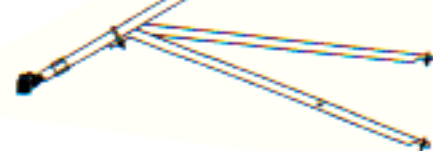

GOOSENECKS

3/4" GALVANIZED GOOSENECKS

Part No.	Description	Price
GNSS-MXF	3/4" x 6" Male x Female	\$5.36
GNSS-MXM	3/4" x 6" Male x Male	\$4.50
GNSS-MXHB	3/4" x 6" Male x Barb	\$6.50
GNSS-8MXF	3/4" x 8" Male x Female (T-L)	Call



PLASTIC GOOSENECKS

3/4" SCH. 80 UV PVC VANMAR GOOSENECKS W/SS INSERT

Part No.	Description	Price
VM-MXF	3/4" x 6" Male x Female	\$8.54
VM-MXM	3/4" x 6" Male x Male	\$8.54
VM-MXB	3/4" x 6" Male x Barb	Call
VM-12MXB	3/4" x 12" Male x Barb Furrow Arm	Call



PLASTIC GOOSENECKS

SENNINGER® GOOSENECKS & TRUSS ROD HOSE SLING

Part No.	Description	Price
GNAP180X6M	3/4" x 6" 180° Male x Male Plastic	\$4.50
GNAP180X6B	3/4" x 6" 180° Male x Barb Plastic	\$4.50
GN180X6M	3/4" x 6" 180° Female x Male	\$3.50
GN180X6B	3/4" x 6" 180° Female x Barb	\$3.50
GN180X6BI	3/4" x 6" 180° Female x 19MM Barb	\$3.50
GN125DM	3/4" 125° Female x Double Male Plastic	\$5.50
GN125DB	3/4" 125° Female x Double Barb Plastic	\$5.50
GNAP125DM	3/4" 125° Male x Double Male Plastic	\$5.00
GNAP125DB	3/4" 125° Male x Double Barb Plastic	\$5.00
GN125SM	3/4" 125° Female x Single Male Plastic	\$3.50
GN125SB	3/4" 125° Female x Single Barb Plastic	\$3.50
GNAP125SM	3/4" x 125° Male x Single Male Plastic	\$3.50
GNAP125SB	3/4" x 125° Male x Single Barb Plastic	\$3.50



Part No.	Description	Price
TRHS-625	Truss Rod Hose Sling, for 5/8" Rod (Rust)	\$2.75
TRHS-687	Truss Rod Hose Sling, for 11/16" Rod (Green)	\$2.75
TRHS-750	Truss Rod Hose Sling, for 3/4" Rod (Black)	\$2.75
TRHS-812	Truss Rod Hose Sling, for 13/16" Rod (Gray)	\$2.75
TRHS-875	Truss Rod Hose Sling, for 7/8" Rod (Blue)	\$2.75
FTN33	3/4" x Close Delrin Nipple	\$0.75

DROPS - READY TO INSTALL

Our Polydrop® was the first product of its kind used. It is still the most widely used drop of its type in the industry. Our Polydrop® is different from any other polyethylene drop used today. It is the #1 drop preferred by dealers, installers, & growers. This drop has been in the field for over 20 years. Our drops have been problem free. Due to its unmatched & unsurpassed problem free track record, make sure that when you order a polyethylene drop it is the true and original Polydrop®. Don't accept any look-alikes.

3/4" SEMI-RIGID PIVOT POLYDROPS®

Part No.	Description	Price
PD-012	12"	Call
PD-018	18"	Call
PD-024	24"	Call
PD-030	30"	Call
PD-036	36"	Call
PD-042	42"	Call
PD-048	48"	Call
PD-054	54"	Call
PD-060	60"	Call
PD-066	66"	Call
PD-072	72"	Call
PD-078	78"	Call
PD-084	84"	Call
PD-090	90"	Call
PD-096	96"	Call
PD-102	102"	Call
PD-108	108"	Call
PD-114	114"	Call
PD-120	120"	Call
PD-126	126"	Call
PD-132	132"	Call
PD-138	138"	Call
PD-144	144"	Call
PD-150	150"	Call
PD-156	156"	Call
PD-162	162"	Call
PD-168	168"	Call
PD-174	174"	Call
PD-180	180"	Call

Specify Ends: Steel MIPT, Plastic MIPT, FIPT or Barb

3/4" GALVANIZED DROPS

Part No.	Description	Price
G-018	18"	Call
G-024	24"	Call
G-030	30"	Call
G-036	36"	Call
G-042	42"	Call
G-048	48"	Call
G-054	54"	Call
G-060	60"	Call
G-066	66"	Call
G-072	72"	Call
G-078	78"	Call
G-084	84"	Call
G-090	90"	Call
G-096	96"	Call
G-102	102"	Call
G-108	108"	Call
G-114	114"	Call
G-120	120"	Call
G-180	180"	Call

Available Male x Male only.

3/4" POLYDROP® W/ 2' OF FLEXIBLE DROP HOSE

Designed for Senninger I-WOB® Systems

Part No.	Description	Bottom Connection	
		Blank	Male
PF-024	24"	Call	Call
PF-030	30"	Call	Call
PF-036	36"	Call	Call
PF-042	42"	Call	Call
PF-048	48"	Call	Call
PF-054	54"	Call	Call
PF-060	60"	Call	Call
PF-066	66"	Call	Call
PF-072	72"	Call	Call
PF-078	78"	Call	Call
PF-084	84"	Call	Call
PF-090	90"	Call	Call
PF-096	96"	Call	Call
PF-102	102"	Call	Call
PF-108	108"	Call	Call
PF-114	114"	Call	Call
PF-120	120"	Call	Call
PF-126	126"	Call	Call
PF-132	132"	Call	Call
PF-138	138"	Call	Call
PF-144	144"	Call	Call
PF-150	150"	Call	Call
PF-156	156"	Call	Call
PF-162	162"	Call	Call

HOSE EXTENSIONS

Part No.	Description	Price
FLEX-18	18"	Call
FLEX-24	24"	Call

Male x Female standard - Other ends please specify.

3/4" X 250' FLEXIBLE DROP HOSE

3/4" x 250' FLEXIBLE DROP HOSE

We are pleased to offer four high quality hoses for your drop hose requirements, Premium, Premium Plus, Senninger & Goodyear Sureline. For more than a decade, we have distributed over 12,000 miles of our Premium and Premium Plus grade drop hose. Installed extensively on over an estimated 25,000 plus center pivot systems, it is the most popular and widely used product of its type in today's marketplace. However, in our quest to improve upon this highly successful product, we asked the question, "can we make the best hose in the market, constructed specifically for drop application, even better at a realistic, affordable price?" We concluded the answer to be "yes," so today you have a choice of four great products.

Premium: A co-extruded liner which has a solid thin inner wall & a thicker foam wall, providing for lighter weight & a more flexible product. Highly durable PVC cover which provides excellent weatherability & maximum resistance to ultra-violet degradation. A knitted synthetic cord reinforcement between the PVC jacket & the inner core. Medium burst strength.
Quality: GOOD

FLEXIBLE DROP HOSE

Part No.	Description	Price
GI-DH750X250	3/4" x 250' Flex Hose	\$105.33



RED FLEXIBLE DROP HOSE

Part No.	Description	Price
PHC-120-12044250	RED DROP HOSE ROLL	\$250.80



POLYWEIGHTS®

POLYWEIGHT® - PLASTIC DROP WEIGHTS NOTCHED & ROUNDED SLEEVE

Part No.	Length	Weight Lbs.	Price
PW-026	26"	2.00	Call
PW-024	24"	2.00	\$6.80
PW-021	21"	1.75	Call
PW-018	18"	1.50	Call
PW-015	15"	1.25	Call
PW-009	9"	.75	Call

POLYWEIGHT® - PLASTIC DROP WEIGHTS ROUNDED & THREADED FIPT X BARB

Part No.	Length	Weight Lbs.	Price
PW-024-FXB	24"	2.00	Call
PW-021-FXB	21"	1.75	Call
PW-018-FXB	18"	1.50	Call
PW-015-FXB	15"	1.25	Call
PW-009-FXB	9"	.75	Call

POLYWEIGHT® - PLASTIC DROP WEIGHTS ROUNDED & THREADED MIPT X BARB

Part No.	Length	Weight Lbs.	Price
PW-024-MXB	24"	2.00	Call
PW-021-MXB	21"	1.75	Call
PW-018-MXB	18"	1.50	Call
PW-015-MXB	15"	1.25	Call
PW-009-MXB	9"	.75	Call

SCH. 40 GALVANIZED STEEL WEIGHT

3/4" MIPT X BARB

Part No.	Length	Weight Lbs.	Price
WT-24-MXB	24"	2.00	Call
WT-18-MXB	18"	1.50	Call
WT-15-MXB	15"	1.25	Call

1" NOTCHED SLEEVE

Part No.	Length	Weight Lbs.	Price
WT-24-NS	24"	3.20	Call
WT-18-NS	18"	2.40	Call
WT-15-NS	15"	2.00	Call

1" NO NOTCH SLEEVE

Part No.	Length	Weight Lbs.	Price
WT-18-NNS	18"	2.40	Call
WT-15-NNS	15"	2.00	Call

APPLICATOR WEIGHTS

SENNINGER® ONE WEIGHT

Part No.	Weight Lbs.	Price
ONEWGT4	.85 Lb. Threaded	\$9.15



SENNINGER® MAGNUM WEIGHT

Part No.	Weight Lbs.	Price
MAGWGTRB	.85 Lb. Threaded	\$6.50
MAGWGTSLP	.85 Lb. Slip	\$6.00



NELSON 3000 SERIES DROP WEIGHT

Part No.	Weight Lbs.	Price
10130	1 Lb. Modular Drop Weight	\$8.47



DROP & CONVERSION FITTINGS

SENNINGER® PLASTIC FITTINGS

Part No.	Description	Price
FTA3F3B	3/4" FIPT x Barb Adapter	\$1.05
FTA3M3B	3/4" MIPT x Barb Adapter	\$0.70
FTA3B3B	3/4" Barb Coupling	\$0.70
FTP3	3/4" MIPT Plug	\$0.80
FTN32	3/4" MIPT x 1/2" MIPT Reducing Nipple	\$0.75
FTN33	3/4" MIPT x Close Nipple	\$0.75
CPL33	3/4" FIPT Coupling	\$1.40
CPL22	1/2" FIPT Coupling	\$1.40
CPL44	1" FIPT Coupling	\$3.00
CPL55	1-1/4" FIPT Coupling	\$7.00
CPL32	3/4" x 1/2" FIPT Reducer Coupling	\$1.40
CPL43	1" x 3/4" FIPT Reducer Coupling	\$2.00
CPL54	1-1/4" x 1" FIPT Reducer Coupling	\$7.00
CPL53	1-1/4" x 3/4" FIPT Reducer Coupling	\$6.00
FTB43	1" x 3/4" Threaded Reducer Bushing	\$2.00



NELSON PLASTIC FITTINGS

Part No.	Description	Price
10057	3/4" Hose Barb x 3/4" FIPT	\$1.24
10148	3/4" Hose Barb x 3/4" MIPT	\$0.78
9901	3/4" Hose Barb x 3000 Adapter	\$1.46



SPEARS PLASTIC FITTINGS

Part No.	Description	Price
MS412-007	3/4" Marlex Street Ell	\$0.93
805-007	3/4" Sch. 80 Threaded Tee	\$5.89
883-005	3/4" x CL Sch. 80 Nipple	\$1.24
883-020	3/4" x 2" Sch. 80 Nipple	\$1.24
883-060	3/4" x 6" Sch. 80 Nipple	\$2.38
883-120	3/4" x 12" Sch. 80 Nipple	\$3.60
1435-007	3/4" FIPT x Insert Adapter	\$3.09
1436-007	3/4" MIPT x Insert Adapter	\$0.78
1429-007	3/4" Insert Coupling	\$0.78
1403-007	3/4" Insert x Insert x MIPT Tee	\$2.64
1413-007	3/4" Insert x MIPT 90° Ell	\$2.23



GALVANIZED FITTINGS

Part No.	Description	Price
NG0502	1" x 2" Nipple	\$2.39
NG0412	3/4" x 12" Nipple	\$7.09
NG0402	3/4" x 2" Nipple	\$1.60
NG0404	3/4" x 4" Nipple	\$2.30
MGPL05	1" MIPT Plug	\$3.00
MGPL04	3/4" MIPT Plug	\$2.74
MGCP04	3/4" FIPT Coupling	\$3.07
MGCP05	1" FIPT Coupling	\$5.06
MGCP06	1-1/4" FIPT Coupling	\$6.96
MG CPR0403	3/4" x 1/2" FIPT Reducer Coupling	\$3.11
MG CPR0504	1" x 3/4" FIPT Reducer Coupling	\$4.80
MG CPR0605	1-1/4" x 1" FIPT Reducer Coupling	\$6.58
MG CPR0604	1-1/4" x 3/4" FIPT Reducer Coupling	\$6.58
MGBU0504	1" x 3/4" Threaded Reducer Bushing	\$4.20
MGBU0604	1-1/4" x 3/4" Thrd. Reducer Bushing	\$5.66
MGT04	3/4" Tee	\$3.84
MGT05	1" Tee	\$6.28



FITTINGS & CLAMPS

STANDARD MERCHANT COUPLER

Size	Black Full Part No.	Price	Black Half Part No.	Price
3/4"	M-CB04	\$2.77	M-HCB04	\$2.22
1"	M-CB05	\$3.87	M-HCB05	\$3.10
2"	M-CB08	\$8.97	M-HCB08	\$7.17



ALUMINUM HALF COUPLER

Part No.	Size	Weight Lbs.	Price
HC075	3/4"	.25	\$8.86
HC100	1"	.32	\$9.74
HC200	2"	1	\$24.16



CLAMPS & TOOLS

Part No.	Description	Price
15500016	271R 3/4" Pinch Clamp for 3/4" Drop Hose	\$0.21
15500020	331R 1" Pinch Clamp for Polydrop®	\$0.23
H1000C	H10 3/4" Gear Clamp for Drop Hose	\$0.85
H1200C	H12 3/4" Gear Clamp for Sureline® Hose	\$0.85
14100082	Standard Handle Pinch Clamp Tool	\$35.40
14100084	Long Handle Pinch Clamp Tool	\$60.88
T135YSS	1.625" OD Kwikcut Cutter with Stainless Blade	Call
T100YSS	1.25" OD Kwikcut Cutter with Stainless Blade	Call



SENNINGER® pioneered pivot regulators and makes a wide range of pivot regulators with multiple flow & pressure combinations. Excellent quality & durability.

SENNINGER® PRESSURE REGULATORS

Part No.	Description	Flow Range (GPM)	Price
PMR-##MF	3/4" FIPT Medium Flow	4 - 16 & 2 - 20	\$17.00
PSR-##	3/4" FIPT All Flow	1/2 - 15	\$10.50
PR-##HF	1-1/4" FIPT x 1" FIPT High Flow	10 - 32	\$34.00

- 6, 10, 12, 15, 20, 25, 30, 35, 40, 50 PSI



SENNINGER SUPER SPRAY®

The Super Spray is Senninger's most versatile spray nozzle. A wide selection of interchangeable snap-in deflector pads are available to address irrigation and chemigation requirements over a variety of crop, climatic and soil conditions. Pads available in 1) Smooth, 2) 36 medium groove, 3) 24, 36 & 48 deep groove. All types of pads available in either concave, flat or convex. Forty-five sizes of color coded nozzles are available to use at a suggested pressure range of 6-30 PSI.

Part No.	Description	Price
SSBRASM-UP3	Super Spray Bracket (Body)	\$3.50
SSPFL-XXXX	Flat Plates (Black)	\$1.80
SSPCC-XXXX	Concave Plates (Blue)	\$1.80
SSPCV-XXXX	Convex Plates (Green)	\$1.80
UP3 NOZZLES	UP3 Nozzle (#4 - 26)	\$1.65



SENNINGER LDN® LOW DRIFT NOZZLE

Based upon nozzle size and flow, the LDN is designed to shear off water from the nozzle stream and direct it onto multiple levels of deflector pads, thereby controlling stream placement off the pad. Also can be used as a single pad spray for maximum throw & droplet size off the pad. Circular design for minimum drag in crop. Pads available in 1) 24 mini and 2) 24 & 33 groove. All types of pads available in either concave, flat and/or convex. Operates best at 6-10 PSI. Multiple irrigation & chemigation pads to select from.

Part No.	Description	Price
LDN-SINGLE-UP3	Complete Spray w/Single Pad - Less Weight	\$5.44
LDN-DOUBLE-UP3	Complete Spray w/Double Pad - Less Weight	\$6.82
LDN-TRIPLE-UP3	Complete Spray w/Triple Pad - Less Weight	\$8.18
LDN-PARTCIRCLE-UP3	Complete Part Circle Spray	\$10.96
LDNB	LDN 3/4" MPT Base	\$5.75
LDNHDC	LDN Cage	\$1.50
UP3 NOZZLES	UP3 Nozzle (#4 - 26)	\$1.65
LDNPHDCXX	Concave Deflector Pads (Blue)	\$1.75
LDNPHDFXX	Flat Deflector Pads (Black)	\$1.75
LDNPHDVXX	Convex Deflector Pads (Green)	\$1.75
LDNPHDPC-CDG17	Part Circle Deflector Pads	\$6.57



SPECIALTY LDN® PADS

Part No.	Description	Price
LDN-UP3	Assembly Single Pad	\$5.44
LDNPHDB	Bubble Pad	\$1.83
LDNHDHBA3	Hose Drag Adapter	\$2.22
LDNPHDCMXX	Corn Chemigation Pad	\$0.59
LDNPHDCOTBXX	Cotton Chemigation Pad	\$1.05



I-WOB® UP3

Part No.	Description	Price
I-WOB-SA-9G-UP3	Inverted 360° Standard Angle 9 Groove (Black Deflector) w/out Weight	\$25.30
I-WOB-LA-9G-UP3	Inverted 360° Low Angle 9 Groove (Blue Deflector) w/out Weight	\$25.30
I-WOB-LA-6G-UP3	Inverted 360° Low Angle 6 Groove (White Deflector) w/out Weight	\$25.30
IWB3-W	3/4" MNPT Base	\$3.55
IWBB3	3/4" Barbed Base	\$3.55
UP3 Nozzle	Nozzle, Color Coded (#7 - #24, Included Half Sizes)	\$1.65
IWNZC	I-WOB Nozzle Carrier	\$1.43
UP3NZCD	I-WOB Dual Nozzle Carrier	\$2.25
IWDHA3	I-WOB Hose Drag Adapter	\$2.22

Specify 3/4" Male (NPT) Base or 3/4" Barbed Base. 9 Groove Deflector: Nozzle (Sizes #6-24)
6 Grooved Deflector: Nozzle (Sizes #12 -24) Must be installed with a minimum hose length of 2'
at bottom of drop.



XI-WOB® UP3

Part No.	Description	Price
XI-WOB-610-UP3	6 Groove 10° Trajectory Blue - for use with #7 - #24	\$25.35
XI-WOB-910-UP3	9 Groove 10° Trajectory Gray - for use with #10 - #24	\$25.35
XI-WOB-615-UP3	6 Groove 15° Trajectory Black - for use with #10 - #24	\$25.35
UP3 Nozzle	Nozzle, Color Coded (#7 - #24, Included Half Sizes)	\$1.65
IWB3-W	3/4" MNPT Base	\$3.55
IWBB3	3/4" Barbed Base	\$3.55

Specify 3/4" Male (NPT) Base or 3/4" Barbed Base. Designed for use on a rigid drop without hose.
Optimal pressure range from 10 to 15 PSI.



WOBLER® FOR UPRIGHT INSTALLATION

Part No.	Description	Price
WOB-SA-3/4" M	3/4" MIPT, Standard Angle, Black Deflector	\$9.00
WOB-LA-3/4" M	3/4" MIPT, Low Angle, White Deflector	\$9.00

Must be installed on drop with WOB-LOOP.



XCEL WOBLER® FOR UPRIGHT INSTALLATION

Part No.	Description	Price
XCEL HA-3/4" M	3/4" MIPT, High Angle, Black Deflector	\$9.00
XCEL MA-3/4" M	3/4" MIPT, Mid Angle, White Deflector	\$9.00

• Mid Angle Apx 18° • High Angle Apx 24° • Nozzle Sizes Available # 6-14



LEPA QUAD-SPRAY®

Part No.	Description	Price
LPAR06	3/4" FIPT Lepa Quad-Spray Complete (Includes 6 PSI Regulator)	\$28.80
LPAR10	3/4" FIPT Lepa Quad-Spray Complete (Includes 10 PSI Regulator)	\$28.80
LPAN	3/4" FIPT Lepa Quad-Spray Complete (Less Regulator, w/Spacer)	\$22.40

FAN SPRAY™

Part No.	Description	Price
FANSPRAY	3/4"MIPT Base, Nozzle (Sizes #5-24)	\$6.00



SENNINGER® FULL CIRCLE IMPACT SPRINKLERS

SENNINGER PIVOT MASTER® FULL CIRCLE LOW ANGLE IMPACTS - 6°

Part No.	Description	Price
3006H-1-3/4"-M-PM	3/4" MIPT Single Noz. 6° w/Brass Swivel	\$25.00
4006H-1-3/4"-M-PM	3/4" MIPT Single Noz. 6° w/Brass Swivel	\$25.00
5006H-1-3/4"-M-PM	3/4" MIPT Single Noz. 6° w/Brass Swivel	\$25.00
4006H-2-3/4"-M-PM	3/4" MIPT Double Noz. 6° w/Brass Swivel	\$25.00
5006H-2-3/4"-M-PM	3/4" MIPT Double Noz. 6° w/Brass Swivel	\$25.00



SENNINGER PIVOT MASTER® FULL CIRCLE MEDIUM ANGLE IMPACTS - 12°

Part No.	Description	Price
3012H-1-3/4"-M-PM	3/4" MIPTe Single Noz. 12° w/Brass Swivel	\$25.00
4012H-1-3/4"-M-PM	3/4" MIPT Single Noz. 12° w/Brass Swivel	\$25.00
5012H-1-3/4"-M-PM	3/4" MIPT Single Noz. 12° w/Brass Swivel	\$25.00
7012SD-2-1"-F	1" FIPT Double Nozzle 12° w/Plastic Swivel	\$60.00



SENNINGER® FULL CIRCLE STANDARD ANGLE IMPACTS - 23° & 25°

Part No.	Description	Price
3023-1-3/4" M	3/4" MIPT Single Noz. 23°	\$12.00
4023-1-3/4" M	3/4" MIPT Single Noz. 23°	\$13.24
5023-1-3/4" M	3/4" MIPT Single Noz. 23°	\$12.24
7025RD-2-1" F	1" FIPT Double Noz. 25°	\$60.00
8025HR-2-1-1/4" F	1-1/4" FIPT Double Noz. 25°	\$144.00



SENNINGER® NOZZLES AND VANES FOR IMPACTS

Description	Range Nozzle / Inserts	Nozzle-Vane Combination	Spreader Nozzle / Inserts	Vaness	Range Nozzle Extension
20	RN-20 \$0.75	NV-20 \$1.20		VANE-20 \$0.60	-
30	RN-30 \$0.75	NV-30 \$1.20		VANE-30 \$0.60	-
40	RN-40 \$0.75	NV-40 \$1.20		VANE-40 \$0.60	-
50	RN-50 \$0.75	NV-50 \$1.20		VANE-50 \$0.60	-
70	RN-70 \$2.50	NV-70 \$0.00	SN-70 \$0.75	VANE-70 \$2.00	-
80	RN-80 \$4.00	NV-80 \$0.00	SN-80 \$0.75	VANE-80 \$4.00	\$6.00



SENNINGER® PLASTIC PART CIRCLE IMPACT SPRINKLERS

3123 NOZZLES #8-10

Part No.	Description	Price
3123PC-1-3/4"M	3/4" MIPT Plastic Swivel	\$32.00
3123PC-1-3/4"F	3/4" MIPT Plastic Swivel with 3/4" Coupling	\$32.00
3123PC-1-1"F	3/4" MIPT Plastic Swivel with 1" x 3/4" Coupling	\$32.00



4123 NOZZLES #10-13

Part No.	Description	Price
4123PC-1-3/4"M	3/4" MIPT Plastic Swivel	\$32.00
4123PC-1-3/4"F	3/4" MIPT Plastic Swivel with 3/4" Coupling	\$32.00
4123PC-1-1"F	3/4" MIPT Plastic Swivel with 1" x 3/4" Coupling	\$32.00



5123 NOZZLES #13-18

Part No.	Description	Price
5123PC-1-3/4"M	3/4" MIPT Plastic Swivel	\$29.68
5123PC-1-3/4"F	3/4" MIPT Plastic Swivel with 3/4" Coupling	\$32.00
5123PC-1-1F	3/4" MIPT Plastic Swivel with 1 x 3/4" Coupling	\$32.00

RAIN BIRD® FULL CIRCLE IMPACT SPRINKLERS

Part No.	Description	Price
A06240	L20VH Wedge Drive 1/2" Male Single Nozzle 10°	\$27.00
A06015	L20H 1/2" Male Single Nozzle 23°	\$27.15
A05840	20JH 1/2" Male Single Nozzle 23°	\$24.35
A07360	L36HB 3/4" Male Plastic w/ Brass Brg. Sleeve, Slotted Spoon 10°	\$32.16
A07350	L36AHB 3/4" Male Plastic w/ Brass Brg. Sleeve, Regular Spoon 10°	\$26.31
A11640	L3030H 3/4" Male Brass Double Nozzle 10°	\$53.07
L46000	46H 3/4" Male Plastic Double Nozzle 23°	\$19.35
A08401	30H 3/4" Male Brass Double Nozzle 27°	\$44.12
A12800	14070H 3/4" Male Double Nozzle 27°	\$63.95
A20000	70CH 1" Female Double Nozzle 21°	\$166.41
A20030	70CHM 1" Male Double Nozzle 21°	\$150.79
A23802	80EHD 1-1/4" Male Double Nozzle 27°	\$306.84

Less Nozzle



RAIN BIRD® PART OR FULL CIRCLE IMPACT SPRINKLERS

Part No.	Description	Price
A34403-10	25BPJ-FP-ADJ-DA-TNT 1/2" Male Brass Impact, PJ Arm, with Diffuser & Distance Control and 5/32" Nozzle	\$47.70
A39200	35A-TNT 3/4" Male Brass Impact Less Nozzle	\$74.18
A4061312	35A-PJ-ADJ-TNT 3/4" Male Brass Impact with PJ Arm & ADJN-3 #12 (3/16") Nozzle	\$89.29
AG2001	65PJ-TNT 1" Female Brass Impact with PJ Arm, Less Nozzle	\$225.14
A23960	85EHD-LA 1-1/4" Male Brass Low Angle Impact, Less Nozzle 17°	\$352.72



RAIN BIRD® NOZZLES & ACCESSORIES FOR IMPACT SPRINKLERS

Part No.	Description	Price
100225-xx	LAN-1-7 Brass 7° Low Angle Nozzle 1/2" Body	\$1.31
100226-xx	LAN-1-20 Brass 20° Low Angle Nozzle 1/2" Body & Spreader Nozzle for 3/4" Bodies & 808A	\$1.31
105780-xx	SBN-1 Brass Straight Bore Nozzle for 1/2" Body	\$0.73
106160-xx	SBN-1V Brass Straight Bore Nozzle w/Vane for 1/2" Body	\$0.97
105842-xx	SBN-3 Brass Straight Bore Nozzle for 3/4" Body	\$1.94
106131-xx	SBN-3V Brass Straight Bore Nozzle w/Vane for 3/4" Body	\$1.58
100382-xx	SBN-4 Brass Straight Bore Nozzle for 1" Body	\$6.95
103043-xx	SBN-5 Brass Straight Bore Nozzle for 1-1/4" Body	\$15.88
100418	SPB-1 Spreader Bushing for 1" Body	\$5.74
105816	NV-3 Nozzle Vane for 3/4" Body	\$0.45
101092-xx	ADJN-1V Brass Adjustable Nozzle w/Vane for 1/2" Body - Limited Qty. Available	Call
100328-xx	ADJN-3 Brass Adjustable Nozzle for 3/4" Body	\$10.63
100385-xx	ADJN-4 Brass Adjustable Nozzle for 1" Body	\$20.42
100332-xx	DAN-3 Brass Do-All Nozzle for 3/4" Body	\$19.39
100255	Brass Plug for 1/2" Body	\$0.91
100289	Brass Plug for 3/4" Body (range)	\$1.75
100417	Brass Plug for 1" Body (spreader side)	\$5.25
107881-xx	Quick-Fit Straight Bore Nozzle for L36 Impact	\$1.61
109247-xx	Quick-Fit Low Pressure Nozzle for L36 Impact	\$1.73
107881-99	Quick-Fit Plug for L36 Impact	\$1.73



NELSON 3000 SERIES PIVOT PRODUCTS

As with all NELSON 3000 Series Pivot Products, each sprinkler type incorporates a user-friendly, modular design with quick change plastic color-coded nozzles. Each body type has a square thread which can be used with a standard 3/4" MPT by square thread base or matched with a square thread regulator which eliminates the need and cost of the base.

NELSON R3000 ROTATOR® (15-50 PSI)

R3000 Rotators offer a slow rotating plate which produces the widest pattern of any below mainline sprinkler. This results in a lower application rate, reduced runoff and longer soak times. R3000 Rotators are available with a wide range of plates with a variety of trajectories & groovings. Up top plates include the U4-8 degree blue and the new U6 multi-trajectory white. Drop plates include the D4-8 degree green, D6-12 degree red, a new D8 multi-trajectory orange & a new D10 multi-trajectory brown plate. Also available with TRASHBUSTER body (TR3000) to reduce the accumulation of debris on the body in dirty water applications. TR3000 rotators available with 3000FCN flow control nozzles for reduced chance of plugging.

Part No.	Description	Price
R3000	Complete Assembly w/3TN & 3/4" MNPT	\$29.57
9410	3000 Adapter 3/4" MNPT	\$1.38
9461-###	3TN Nozzle	\$1.81
9412	R/S3000 Series Body	\$2.24
Specify Color	R3000 Plates	\$5.09
9539	R3000 Cap/Motor	\$19.03



NELSON S3000 SPINNER (10-20 PSI)

S3000 Spinners utilize the higher speed spinning action of the rotor plate to produce a gentle rain-like droplet for sensitive soils and crops. A low pressure alternative to fixed sprayheads, the S3000 provides higher uniformity with better overlap and lower application rates. Available plates include the D6-12 degree red, D6-20 degree purple and new D8 multi-trajectory yellow.

Part No.	Description	Price
S3000	Complete Assembly w/3TN & 3/4" MNPT	\$24.65
9410	3000 Adapter 3/4" MNPT	\$1.38
9461-###	3TN Nozzle	\$1.81
9412	R/S3000 Series Body	\$2.24
Specify Color	S3000 Plate	\$5.09
9540	S3000 Cap/Motor	\$14.11



NELSON D3000 SPRAYHEAD (6-40 PSI)

The flip over dual spray cap on the D3000 allows for easy conversion of the spray pattern. Choose from spray plate options to germinate, irrigate & chemigate. Plate selection includes 1) smooth flat, 2) 30 stream fine groove in either concave, flat or convex, 3) 36 stream medium deep groove in either concave or flat, 4) 24 stream coarse deep groove flat, 5) 21 stream coarse deep groove & 33 stream medium deep groove multi-trajectory & 6) corn & cotton chemigation. For Low Energy Precision Application (LEPA), utilize HDA hose drag adapters to attach 3/4" drag hose or drag socks. You may also snap on a bubbler clip to create a LEPA bubbler. Circular design allows for easy passage through the thickest foliage.

Part No.	Description	Price
D3000	Complete Assembly w/3TN & 3/4" MNPT	\$6.30
9410	3000 Adapter 3/4" MNPT	\$1.38
9461-###	3TN Nozzle	\$1.81
9428	A/D3000 Body	\$1.39
9429	D3000 Cap	\$0.89
Specify Color	D3000 Plate	\$0.81
9427	HD Hose Drag Adapter	\$2.50
10577	Bubbler Ring	\$1.46



NELSON PART CIRCLE 3000 SERIES PIVOT PRODUCTS

The PART CIRCLE 3000 SERIES was developed for use on either side of pivot towers to reduce the amount of water applied to the wheel track area. The part circle directional control is produced by a stream deflector between the nozzle & the body. The stream deflector, plates & motors are unique to the PC R3000 Part Circle & PC S3000 Part Circle & may not be used with standard R3000 Rotators & S3000 Spinners. The PC D3000 Part Circle sprayhead is used mainly with low pressure spray systems. PART CIRCLE 3000 SERIES Sprinklers are also being used as endguns with great success. With up to 35 feet of throw & no stalling due to low pressure they are a problem free answer to adding productive acres to your field.

NELSON PC-R3000 PART CIRCLE ROTATOR® (15-30 PSI)

The PC R3000 Part Circle Rotator comes with two different plates. Use the white plate for nozzle sizes #14 - #35 & the black plate for nozzle sizes #36 - #50. Coarse grooved plates create healthy droplets that fight wind & increase distance of throw. The part circle mechanism comes as an assembly which includes the stream deflector, body, plate, cap & motor. 190° Arc with up to 35 feet of throw.

Part No.	Description	Price
PC-R3000	Complete Assembly w/3TN & 3/4" MNPT	\$41.67
9410	3000 Adapter 3/4" MNPT	\$1.38
9461-###	3TN Nozzle	\$1.81
10843-###	PC R3000 Less Nozzle & Less Adapter	\$38.48

NELSON PC-S3000 PART CIRCLE SPINNER (10-20 PSI)

The PC S3000 Part Circle Spinner uses one plate to cover the entire nozzle range of #14 - #40. Being in the Spinner family it produces a gentle, rain-like droplet. The part circle mechanism comes as an assembly which includes the stream deflector, body, plate, cap & motor. 190° Arc with up to 26 feet of throw.

Part No.	Description	Price
PC-S3000	Complete Assembly w/3TN & 3/4" MNPT	\$33.21
9410	3000 Adapter 3/4" MNPT	\$1.38
9461-###	3TN Nozzle	\$1.81
9926-001	PC S3000 Less Nozzle & Less Adapter	\$30.02

NELSON PC-D3000 PART CIRCLE SPRAYHEAD (10-20 PSI)

The PC D3000 Part Circle Sprayhead uses one plate to cover the entire nozzle range of #9 - #50. This 170° medium groove concave plate produces small streamlets that travel up to 19'. The body and plate come as an assembly.

Part No.	Description	Price
PC-D3000	Complete Assembly w/3TN & 3/4" MNPT	\$15.59
9410	3000 Adapter 3/4" MNPT	\$1.38
9461-###	3TN Nozzle	\$1.81
9894-001	PC D3000 Less Nozzle & Less Adapter	\$12.41



NELSON 3000 SERIES PIVOT PRODUCTS

NELSON A3000 ACCELERATOR (10-15 PSI)

Designed as a hybrid of Rotator® & Spinner technology, the Accelerator increases rotation speed as nozzle size increases. Smaller nozzles rotate slowly giving maximum distance of throw & reduced misting. As the nozzle size increases the plate speeds up keeping a uniform size droplet over a large range of nozzles. Created with corn in mind, the droplet size is healthy & the rotating streams penetrate through the foliage much better than conventional sprays. As a rotating type sprinkler the A3000 produces a wider pattern, compared to sprays, resulting in a lower application rate, reduced runoff, higher uniformity & longer soak times.

Part No.	Description	Price
A3000	Complete Assembly w/3TN & 3/4" MNPT	\$19.26
9410	3000 Adapter 3/4" MNPT	\$1.38
9461-###	3TN Nozzle	\$1.81
9428	A/D3000 Body	\$1.39
9906	A3000 Plate	\$3.50
10402	A3000 Cap/Motor	\$11.16



NELSON T3000 TRASHBUSTER SPRAYHEAD

Land application of wastewater through center pivots is proving itself to be an excellent solution. Proper waste management through a center pivot can be both cost effective & environmentally safe. Land applications of wastewater include livestock waste, municipalities, industrial processing & food processing. The T3000 TRASHBUSTERS open body design allows debris to pass off the plate with reduced opportunity of clinging to the struts. Commonly used with medium 30 groove plates to reduce the chance of debris sticking to a deeper grooved plate. The T3000 is also used with 3000FCN Flow Control Nozzles to reduce plugging.

Part No.	Description	Price
T3000	Complete Assembly w/3TN & 3/4" MNPT	\$9.17
T3000	Complete Assembly w/FCN & 3/4" MNPT	\$17.31
9410	3000 Adapter 3/4" MNPT	\$1.38
9461-###	3TN Nozzle	\$1.81
10106-####	3000FCN Flow Control Nozzle	\$9.94
10419	T3000 Body	\$2.29
Specify Color	T3000 Cap & Plate	\$3.69



NELSON O3000 ORBITOR® (10-15 PSI)

Featuring technology that eliminates the struts of a sprinkler body, Nelson's new Pivot Orbitor provides outstanding uniformity and optimal droplets at low pressures (10-20 psi). Expect long wear life and durability in poor water conditions, because there are no sprinkler body struts for debris to hang up on.

Part No.	Description	Price
O3000	Complete Assembly w/3TN & 3/4" MNPT	\$35.17
9410	3000 Adapter 3/4" MNPT	\$1.38
9461-###	3TN Nozzle	\$1.81
11488	O3000 Body & Weight	\$31.98



NELSON 3000 SERIES PIVOT PRODUCTS & ACCESSORIES

3TN DUAL NOZZLE CLIP

Holds two separate 3TN nozzles for dual-flow sprinkler packages. Change flow rates quickly & accurately to meet differing application requirements & seasonal demands. No reading the printout on a wet or windy day & no searching through the bucket to find the right nozzle. Just twist off the body & flip the clip over. Clips are clearly marked with a HI on the square side and LO on the rounded side.

Part No.	Description	Price
9742	Dual Nozzle Clip Only	\$1.53



3TN TRIPLE NOZZLE CLIP

Holds three separate 3TN nozzles for tri-flow sprinkler packages. Change flow rates quickly & accurately for those wells that just won't stay constant. Same easy change method as the dual nozzle clip. Three nozzle chambers clearly marked with a 1 LOW pointed side, a 2 MED round side & a 3 HIGH square side. Do not use with D3000 red plate.

Part No.	Description	Price
11089	Triple Nozzle Clip Only	\$2.38



SQUARE THREAD X HOSE BARB ADAPTER

For use when installing from 3/4" drop hose directly into a Nelson 3000 Series sprinkler. Eliminates additional fittings & saves time & labor.

Part No.	Description	Price
9901	Square Thread x Hose Barb Adapter	\$1.46



NELSON 3000 SERIES BLUE TOP REGULATORS

Nelson introduces the new single strut regulator design. Instead of having 3 or 4 struts holding the regulator seat in place, all new Blue Top regulators will have one heavy duty strut only. This opens up the seat area to help reduce plugging on the upstream side of the regulator. Along with the standard 3/4" FIPT by 3/4" FIPT model, Nelson makes the 3/4" FIPT by square thread (ST) model. This eliminates the need & cost of a threaded adapter, as the regulator screws directly into the body of any 3000 Series sprinkler.

PSI	Universal-Flo (GPM)	Hi-Flo (GPM)
6	.5 - 8	4 - 16
10	.5 - 10	4 - 16
15, 20, 25, 30, 40	.5 - 12	2 - 20



Part No.	Description	Price
9572-001	Reg,Lo-Flo,Blue,SQ. Thread 6 PSI	\$10.24
9572-002	Reg,Lo-Flo,Blue,SQ. Thread 10 PSI	\$10.24
9572-003	Reg,Lo-Flo,Blue,SQ. Thread 15 PSI	\$10.24
9572-004	Reg,Lo-Flo,Blue,SQ. Thread 20 PSI	\$10.24
9572-005	Reg,Lo-Flo,Blue,SQ. Thread 25 PSI	\$10.24
9572-006	Reg,Lo-Flo,Blue,SQ. Thread 30 PSI	\$10.24
9572-007	Reg,Lo-Flo,Blue,SQ. Thread 40 PSI	\$10.24
9572-008	Reg,Lo-Flo,Blue,SQ. Thread 50 PSI	\$10.24

Part No.	Description	Price
9611-001	Reg, Hi-Flo, Blue, SQ Thread 6 PSI	\$17.32
9611-002	Reg, Hi-Flo, Blue, SQ Thread 10 PSI	\$17.32
9611-003	Reg, Hi-Flo, Blue, SQ Thread 15 PSI	\$17.32
9611-005	Reg, Hi-Flo, Blue, SQ Thread 20 PSI	\$17.32
9611-006	Reg, Hi-Flo, Blue, SQ Thread 25 PSI	\$17.32
9611-007	Reg, Hi-Flo, Blue, SQ Thread 30 PSI	\$17.32
9611-008	Reg, Hi-Flo, Blue, SQ Thread 40 PSI	\$17.32
9611-009	Reg, Hi-Flo, Blue, SQ Thread 50 PSI	\$17.32

Part No.	Description	Price
9491-001	Reg,Lo-Flo,Blue,FXF, 6 PSI	\$11.38
9491-002	Reg,Lo-Flo,Blue,FXF, 10 PSI	\$11.38
9491-003	Reg,Lo-Flo,Blue,FXF, 15 PSI	\$11.38
9491-004	Reg,Lo-Flo,Blue,FXF, 20 PSI	\$11.38
9491-005	Reg,Lo-Flo,Blue,FXF, 25 PSI	\$11.38
9491-006	Reg,Lo-Flo,Blue,FXF, 30 PSI	\$11.38
9491-007	Reg,Lo-Flo,Blue,FXF, 40 PSI	\$11.38
9491-008	Reg,Lo-Flo,Blue,FXF, 50 PSI	\$11.38

Part No.	Description	Price
9071-001	Reg,Hi-Flo,Blue,FXF, 6 PSI	\$17.74
9071-002	Reg,Hi-Flo,Blue,FXF, 10 PSI	\$17.74
9071-003	Reg,Hi-Flo,Blue,FXF, 15 PSI	\$17.74
9071-005	Reg,Hi-Flo,Blue,FXF, 20 PSI	\$17.74
9071-006	Reg,Hi-Flo,Blue,FXF, 25 PSI	\$17.74
9071-007	Reg,Hi-Flo,Blue,FXF, 30 PSI	\$17.74
9071-008	Reg,Hi-Flo,Blue,FXF, 40 PSI	\$17.74
9071-009	Reg,Hi-Flo,Blue,FXF, 50 PSI	\$17.74

Note: Limited quantities of 6, 10, & 15 PSI "ST" by barb Universal-Flo regulators are available. This combination reduces your overall cost by eliminating the male by barb fitting. Also saves time and labor.



END OF PIVOT SPRINKLERS

Part No.	Description	Price
R55	End of Pivot Sprinkler (15-40 PSI) 40-55'	\$294.49
R55I	End of Pivot Sprinkler (15-40 PSI) 40-55'	\$294.49
R75	End of Pivot Sprinkler (25-60 PSI) 50-70'	\$529.33

NELSON Impacts are of the highest quality. Every impact is individually water tested before it leaves the factory. Extended life bearings make for longer life and wear.

NELSON FULL CIRCLE IMPACTS

Part No.	Description	Price
7118	F70AM 1" Male Brass Double Nozzle 15°	\$288.00

Less Nozzle



NELSON PART OR FULL CIRCLE BRASS IMPACTS

Part No.	Description	Price
8805	P65M 1" Male Single Nozzle 24°	\$433.00
8426	P85 1-1/4" Male Double Nozzle 24°	\$706.00
8079	P85AS 1-1/4" Male Single Nozzle 18°	\$646.00

Less Nozzle

For the P85A refer to sprinkler section.



NELSON NOZZLES, VANES & ACCESSORIES

Part No.	Description	Price
2FCN	Flow Control Nozzle for L20-04T	\$6.31
3FCN	Flow Control Nozzle for F33AS, F33AA & F44AAB	\$9.65
7RN	Drive Nozzle F70M, F70AM & P65M	\$8.42
8DRN	Drive Nozzle F80, F80A, P85, P85A & P85AS	\$20.60
3RNPLUG	Brass Secondary Plug for F70A, F80A, P85, F44AAB	\$3.19
7V	Stream Straightener for F70M, F70AM & P65M	\$1.63
8V	Stream Straightener for all 80 & 85 Series Impacts	\$1.74
8ADN	Adjustable Diffuser Assembly (Including Nozzle)	\$114.00
8DN	Diffuser Assembly Only (No Nozzle)	\$91.29
8806	P65 1" PC Bearing Assembly	\$143.66
9036	P85 1-1/4" PC Bearing Assembly	\$490.50
7714	P85A & P85AS 1-1/4" PC LA Bearing Assembly	\$354.37



NELSON BIG GUN SPRINKLERS

Part No.	Description	Price
10279-121	F 75 x 21° x 2" Full Circle w/HD Lower Bearing	\$887.00
10279-124	F 75 x 24° x 2" Full Circle w/HD Lower Bearing	\$887.00
10229-118	SR 75 x 18° x 2" Part Circle w/HD Lower Bearing	\$1,105.00
10229-121	SR 75 x 21° x 2" Part Circle w/HD Lower Bearing	\$1,105.00
10229-124	SR 75 x 24° x 2" Part Circle w/HD Lower Bearing	\$1,105.00
8211-038	F 100 x 18° x 2" Full Circle	\$903.00
8211-042	F 100 x 21° x 2" Full Circle	\$903.00
8211-046	F 100 x 24° x 2" Full Circle	\$903.00
8211-147	QC-F100 x 24° Full Circle w/Integral Valve Key	\$2,385.00
8211-098	SR 100 x 18° x 2" Part Circle	\$1,385.00
8211-102	SR 100 x 21° x 2" Part Circle	\$1,385.00
8211-106	SR 100 x 24° x 2" Part Circle	\$1,385.00
8211-143	QC-SR100 x 24° Part Circle w/Integral Valve Key	\$2,987.00
8211-110	SRNV 100E x 18° Part Circle w/Solenoid	\$2,109.00
9643	SRNV 100H x 18° x 2" Part Circle w/out Solenoid	\$1,921.00
9455-021	F150 x 21° Full Circle - Flanged Connection	\$1,767.00
9455-024	F150 x 24° Full Circle - Flanged Connection	\$1,767.00
8463-221	SR150 x 21° Part Circle - Flanged Connection	\$2,197.00
8463-224	SR150 x 24° Part Circle - Flanged Connection	\$2,197.00
9292-001	SR150 x 43° Part Circle - Flanged Connection	\$2,393.00
10055-001	SRA150 Adjustable Trajectory - Flanged Connection	\$2,997.00
6080	F200 x 21° Full Circle - Flanged Connection	\$2,918.00
6260	F200 x 24° Full Circle - Flanged Connection	\$2,918.00
6000	F200 x 27° Full Circle - Flanged Connection	\$2,918.00
9192-021	SR200 x 21° Part Circle - Flanged Connection	\$4,215.00
9192-024	SR200 x 24° Part Circle - Flanged Connection	\$4,215.00
9192-027	SR200 x 27° Part Circle - Flanged Connection	\$4,215.00
(1)	for Anodized F100 or SR100 add	Call
(2)	for Anodized & Powder Coated F100 or SR100 add	Call
(3)	for Anodized F150 or SR150 add	Call
(4)	for Anodized & Powder Coated F150 or SR150 add	Call
(5)	for Anodized SR200 add	Call
(6)	for Anodized & Powder Coated SR200 add	Call



Coating options not available for F200.

TRAJECTORIES AVAILABLE

Big Gun®	Trajectory Angle
75 SERIES	21°, 24°, 43°
100 SERIES	18°, 21°, 24°, 43°
150 SERIES	21°, 24°, 27°, 43°, 15°-45° Adjustable
200 SERIES	21°, 24°, 27°

CONNECTIONS AVAILABLE

Big Gun®	Size Connections
75 SERIES	1-1/2", 2" FNPT, ANSI/DIN, Nelson, Metric, 2-1/2" FNPT
100 SERIES	2" or 2 1/2" FNPT & ANSI/DIN, Nelson, Metric
150 SERIES	3" or 3 1/2" Fem. x Flange & ANSI/DIN, Nelson, Metric
200 SERIES	3" or 4" Fem. x Flange & ANSI/DIN, Nelson, Metric



NELSON BIG GUN® NOZZLES

75 SERIES TAPER RING

Part No.	Size	Price
10208-040	.40"	\$22.75
10208-045	.45"	\$22.75
10208-050	.50"	\$22.75
10208-055	.55"	\$22.75
10208-060	.60"	\$22.75
10208-065	.65"	\$22.75
10208-070	.70"	\$22.75
10208-075	.75"	\$22.75
10208-080	.80"	\$22.75
10207	Noz. Cap Only	\$34.36



100 SERIES TAPER BORE NOZZLES

Part No.	Size	Price
9309-050	.50"	\$51.95
9309-055	.55"	\$51.95
9309-060	.60"	\$51.95
9309-065	.65"	\$51.95
9309-070	.70"	\$51.95
9309-075	.75"	\$51.95
9309-080	.80"	\$51.95
9309-085	.85"	\$51.95
9309-090	.90"	\$51.95
9309-100	1.0"	\$51.95



100 SERIES RING NOZZLES

Part No.	Description	Price
6749	100R Ring Nozzle Set	\$130.00
7872	Ring Nozzle Cap Only (use only with 100R)	\$22.06
6745	Ring Nozzle Cap Only (use only with 100TR)	\$22.45
9956-001	Ring or Taper Ring Nozzle Body Only	\$48.30
6847	Set of 7 Rings Only	\$63.95
6738-060	R100 .60" Individual Ring Only	\$9.20
6738-071	R100 .71" Individual Ring Only	\$9.20
6738-077	R100 .77" Individual Ring Only	\$9.20
6738-081	R100 .81" Individual Ring Only	\$9.20
6738-086	R100 .86" Individual Ring Only	\$9.20
6738-089	R100 .89" Individual Ring Only	\$9.20
6738-093	R100 .93" Individual Ring Only	\$9.20
6738-096	R100 .96" Individual Ring Only	\$9.20

Note: Contact Factory for Pricing and Availability of Anodized and Anodized & Powder Coated.



100 SERIES TAPER RINGS

Part No.	Description	Price
9237-016	TR100 .63" Individual Taper Ring 16MM	\$22.96
9237-017	TR100 .67" Individual Taper Ring 17MM	\$22.96
9237-018	TR100 .71" Individual Taper Ring 18MM	\$22.96
9237-019	TR100 .75" Individual Taper Ring 19MM	\$22.96
9237-020	TR100 .79" Individual Taper Ring 20MM	\$22.96
9237-021	TR100 .83" Individual Taper Ring 21MM	\$22.96
9237-022	TR100 .87" Individual Taper Ring 22MM	\$22.96
9237-023	TR100 .91" Individual Taper Ring 23MM	\$22.96
9237-024	TR100 .95" Individual Taper Ring 24MM	\$22.96



150 SERIES TAPER BORE NOZZLES

Part No.	Description	Price
9317-070	150T .70"	\$88.56
9317-080	150T .80"	\$88.56
9317-090	150T .90"	\$88.56
9317-100	150T 1.0"	\$88.56
9317-110	150T 1.1"	\$88.56
9317-120	150T 1.2"	\$88.56
9317-130	150T 1.3"	\$88.56
9317-140	150T 1.4"	\$88.56



150 SERIES RING NOZZLES

Part No.	Description	Price
6790	150R Ring Nozzle Set	\$214.00
6286	Ring Nozzle Cap Only	\$48.34
9773	Ring Nozzle Body Only	\$79.13
6846	Set of 7 Rings Only	\$128.00
6287-086	R150 .86" Individual Ring Only	\$19.06
6287-097	R150 .97" Individual Ring Only	\$19.06
6287-108	R150 1.08" Individual Ring Only	\$19.06
6287-118	R150 1.18" Individual Ring Only	\$19.06
6287-126	R150 1.26" Individual Ring Only	\$19.06
6287-134	R150 1.34" Individual Ring Only	\$19.06
6287-141	R150 1.41" Individual Ring Only	\$19.06
6287-147	R150 1.47" Individual Ring Only	\$19.06

Note: Contact Factory for Pricing and Availability of Anodized and Anodized & Powder Coated.



150 SERIES TAPER RINGS

Part No.	Description	Price
9238-022	TR150 22MM (.87")	\$28.22
9238-024	TR150 24MM (.95")	\$28.22
9238-026	TR150 26MM (1.02")	\$28.22
9238-028	TR150 28MM (1.10")	\$28.22
9238-030	TR150 30MM (1.18")	\$28.22
9238-032	TR150 32MM (1.26")	\$28.22
9238-034	TR150 34MM (1.33")	\$28.22



200 SERIES TAPER BORE NOZZLES

Part No.	Description	Price
9323-105	200T 1.05"	\$147.00
9323-110	200T 1.10"	\$147.00
9323-120	200T 1.20"	\$147.00
9323-130	200T 1.30"	\$147.00
9323-140	200T 1.40"	\$147.00
9323-150	200T 1.50"	\$147.00
9323-160	200T 1.60"	\$147.00
9323-175	200T 1.75"	\$147.00
9323-190	200T 1.90"	\$147.00



200 SERIES RING NOZZLES

Part No.	Description	Price
6789	200R Ring Nozzle Set	\$314.00
9972-001	Ring Nozzle Body, Only	\$158.00
6026	Ring Nozzle Cap, Only	\$71.80
6845	Set of 7 Rings Only	\$203.00
6027-129	R200 1.29" Individual Ring Only	\$29.14
6027-146	R200 1.46" Individual Ring Only	\$29.14
6027-156	R200 1.56" Individual Ring Only	\$29.14
6027-166	R200 1.66" Individual Ring Only	\$29.14
6027-174	R200 1.74" Individual Ring Only	\$29.14
6027-183	R200 1.83" Individual Ring Only	\$29.14
6027-193	R200 1.93" Individual Ring Only	\$29.14



Note: Contact Factory for Pricing and Availability of Anodized and Anodized & Powder Coated.

100 SERIES HEAVY-DUTY LOWER BEARING

Part No.	Description	Price
7863	2" FNPT Full Circle Bearing Assembly	\$569.00
7864	1-1/2" FNPT Full Circle Bearing Assembly	\$569.00
7862	Flanged Full Circle Bearing Assembly	\$569.00
7273	2" Part Circle Bearing Assembly	\$617.00
7277	2-1/2" Part Circle Bearing Assembly	\$617.00
7753	Flanged Part Circle Bearing Assembly	\$617.00
7950	2" FNPT Part Circle Nozzle Valve Bearing Assy.	\$641.00



150 & 200 SERIES LOWER BEARING ASSEMBLY

Part No.	Description	Price
8458	150 Series Lower Bearing Assembly Flg. Conn.	\$1,021.40
10323-001	150 Series Lower Bearing Assembly ANSI Conn.	\$1,021.40
9114-000	200 Series Lower Bearing Assembly Flg. Conn.	\$2,181.41
9114-003	200 Series Lower Bearing Assembly ANSI Conn.	\$2,181.41



BIG GUN® ACCESSORIES

Part No.	Description	Price
8403-001	150 FI 3" FNPT x Flange Adapter	\$124.00
6621-00	200 FI 3 1/2" FNPT x Flange Adapter	\$110.00
9127	200 FI 4" FNPT x Flange Adapter	\$171.00
9724	Secondary Nozzle Kit	\$34.42
9822	SR100 & SR150 Drive Arm Maintenance Kit	\$111.46
9857	SR100 LPV Kit (low pressure drive vane)	\$16.96
6671	600V Stream Straightener Vane (fits 2" x 6" riser)	\$46.35
8386	100 CBK Series Counter Balance Kit	\$411.00
8399	150 CBK Series Counter Balance Kit	\$424.00
11090	75 Drive Arm Maintenance Kit	\$84.92
10088-001	100FI 2" MNPT X Nelson Flange Adapter	\$67.77
10333-001	Flange ASSY, 4" ANSI - HD200	\$350.03



CONTROL VALVES

NELSON 800 SERIES CONTROL VALVES



As a hydraulically operated sleeve-type valve, the 800 Series Control Valve is designed for versatility. The basic body can be equipped with several different options for controlling pressure and flow in piping systems ranging from drip irrigation to center pivot end guns. It's also engineered for extremely high efficiency, resulting in low pressure loss and high flow capacity.

The MANUAL ON-OFF model of the 800 Series Control Valve is a hydraulically operated sleeve type valve with a manual control function.

The ELECTRIC ON-OFF model of the 800 Series Control Valve is a hydraulically operated sleeve type valve with an electric solenoid control.

Pressure control valves react or respond through a pressure control regulator.

The basic 800 Series Control Valve body can be equipped with several different control packages in various combinations for controlling pressure and flow in large piping systems.

The Nelson 800 Series valve can be equipped with the Rate-Of-Flow (Model D18) control to regulate the flow rate passing through the valve.



TO ORDER: Select one option from each of the five sections to build the valve description code and price.

Section	1. Size/Material/Connections	2. Pressure	3. Pressure Control	4. On/Off Control	5. Filter
Code	A6 B5	C3	D01	D01	H3
Description	6" Cast Iron Wafer w/Stud Kit	Medium (18-80 psi)	None	Manual Selector Only	Internal Filter
List Price = \$1535	\$1,369	\$0	\$0	\$75	\$91

1. Size/Material/Connections			
Code	Material	Connections	List Price
A2 B3	Cast Iron	2" Threaded (NPT)	\$487
A2 B6		2" Victaulic	\$469
A2 B9	Aluminum	Wafer (no stud kit)	\$315
A2 B10		Wafer w/ stud kit for 2" Flanges	\$393
A2 B17		Wafer w/ stud kit for 75/100 Big Gun	\$386
3" Valves			
A3 B6	Cast Iron	3" Victaulic	\$731
A3 B9	Aluminum	Wafer (no stud kit)	\$533
A3 B10		Wafer w/ stud kit for 3" Flanges	\$616
A3 B17		Wafer w/ stud kit for 150 Big Gun	\$609
4" Valves			
A4 B4	Cast Iron	Wafer (no stud kit)	\$905
A4 B5		Wafer w/ stud kit for 4" Flanges	\$993
A4 B21		Wafer 6x4x6 (no stud kit)	\$1,015
A4 B22		Wafer 6x4x6 w/ stud kit	\$1,131
A4 B9	Aluminum	Wafer (no stud kit)	\$742
A4 B10		Wafer w/ stud kit for 4" Flanges	\$830
A4 B17		Wafer w/ stud kit for 200 Big Gun	\$826
A4 B23		Wafer 6x4x6 (no stud kit)	\$852
A4 B24		Wafer 6x4x6 w/ stud kit	\$968
6" Valves			
A6 B4	Cast Iron	Wafer (no stud kit)	\$1,253
A6 B5		Wafer w/ stud kit for 6" Flanges	\$1,369
A6 B21		Wafer 8x6x8 (no stud kit)	\$1,433
A6 B22		Wafer 8x6x8 w/ stud kit	\$1,587
8" Valves			
A8 B4	Cast Iron	Wafer (no stud kit)	\$2,531
A8 B5		Wafer w/ stud kit for 8" Flanges	\$2,685

2. Pressure		
Code	Operating Pressure	List Price
C1	Low (10-50 psi)	\$0
C2	High (30-200 psi)	\$0
C3	Medium (18-80 psi)	\$0

3. Pressure Control		
Code	ADJ. Range	List Price
D01	None	-
Pressure Reducing		
D02	5-30 psi, 4-8"	\$750
D03	5-60 psi, 4-8"	
D04	10-120 psi, 4-8"	
D11	5-30 psi, 2" & 3"	\$406
D12	5-60 psi, 2" & 3"	
D13	10-120 psi, 2" & 3"	
Pressure Sustaining		
D05	25-200 psi, 4-8"	\$750
D08	10-120 psi, 4-8"	
D09	5-60 psi, 4-8"	
D15	5-60 psi, 2" & 3"	\$406
D16	10-120 psi, 2" & 3"	
Rate of Flow		
D18-1	3" Pipe, 120-400 gpm	\$715
D18-2	4" Pipe, 200-550 gpm	
D18-3	6" Pipe, 350-1000 gpm	
D18-4	6" Pipe, 500-2000 gpm	
D18-5	8" Pipe, 500-1550 gpm	
D18-6	8" Pipe, 900-3800 gpm	
Sleeve Exhaust		
D06	Valve open below 30 psi	\$527
D06-1	Valve open below 10 psi	
Shuttle Check		
D07	Shuttle Check	\$130

D18 SPECIFY GPM

4. On/Off Controls*		
Code	ADJ. Range	List Price
E00	None	-
E01	Manual Selector Only	\$75
Manual Selector with Solenoid		
E11	E11 Solenoid - 12 VDC, 1.6mm, NC†	\$254
E20	E20 Window+ Controller, 1.6mm (4-8")	\$458
E21	E21 Solenoid - 12 VDC, 1.6mm	\$550
E23	E23 Solenoid - 9-12 VDC Lat., 1.2mm	\$173
E25	E25 Solenoid - 12 VDC, 3.2mm, NC†	\$466
E29	E29 Solenoid - 12-40 VDC Lat., 2.0mm	\$256
E30	E30 Solenoid - 24 VDC, 1.6mm	\$350
E31	E31 Window+ Controller, 1.2mm (2" & 3")	\$377
E34	E34 Solenoid - 24 VDC, 1.2mm	\$201
E40	E40 Solenoid - 24 VAC, 1.6mm, 2.5W	\$210
E41	E41 Solenoid - 24 VAC, 1.6mm, 8W	\$334
E43	E43 Solenoid - 24 VAC, 1.2mm, 3W	\$173
E46	E46 Solenoid - 24 VAC, 1.6mm, 5.5W	\$210
E50	E50 Solenoid - 120 VAC, 1.6mm, 8W	\$334
E52	E52 Solenoid - 120 VAC, 3.2mm, 17W	\$571
E53	E53 Solenoid - 110 VAC, 1.6mm, 5.5W	\$252

5. Filter		
Code	Filter	List Price
H2	External Filter	\$152
H3	Internal Filter (2" & 3")	\$64
	Internal Filter (4-8")	\$91
Filter with Tubing Protection		
H4	External Filter	\$206
H5	Internal Filter (2" & 3")	\$119
	Internal Filter (4-8")	\$146

SPECIFY VALVE SIZE



*Contact Factory for full solenoid specifications.

Other models available for special order.

†Normally closed solenoid for pressure sustaining, normally open valve ("PSNO") for applications at filter stations.

CLOSED: Upstream water is applied to the outer sleeve chamber, the sleeve becomes hydraulically balanced & the flow passage is closed off by the sleeve pressing against the center seat.

OPEN: Water pressure is relieved from the sleeve chamber, allowing the valve to open.

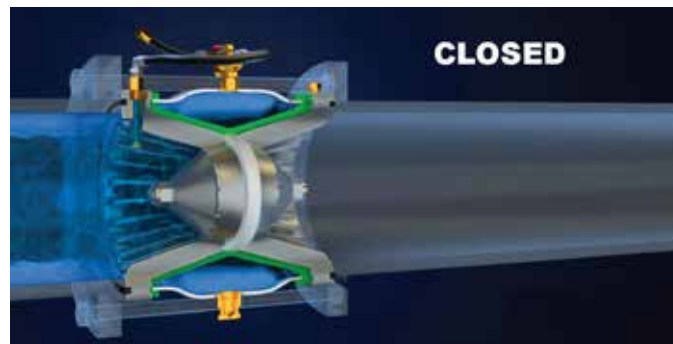
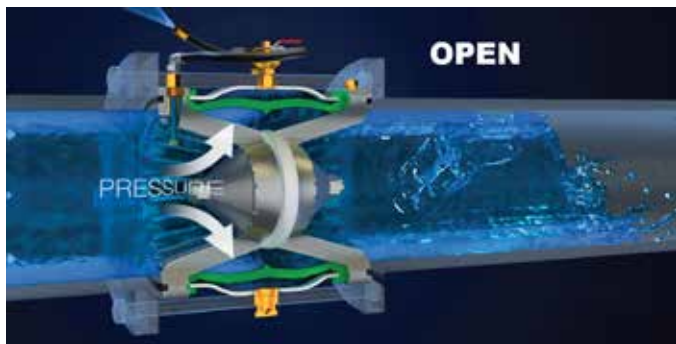

Nelson Control Valves come standard normally closed.

Use the following codes to specify non-standard, normally open, or special solenoid plumbing logic.

Optional Solenoid Logic											
Solenoid Only			Sustaining w/ Solenoid			Reducing w/ Solenoid			Sustaining/Reducing w/ Solenoid		
Code	Solenoid Status	Valve Status	Code	Solenoid Status	Valve Status	Code	Solenoid Status	Valve Status	Code	Solenoid Status	Valve Status
L02	Energized	Closed	L03	Energized	Sustaining	L08	Energized	Closed	L09	Energized	Sustaining-Reducing
	De-energized	Open		De-energized	Closed		De-energized	Open		De-energized	Closed
			L04 †	Energized	Sustaining				L10	Energized	Sustaining
				De-energized	Open					De-energized	Reducing
			L05	Energized	Closed				L11	Energized	Reducing
				De-energized	Sustaining					De-energized	Sustaining
			L06	Energized	Open						
				De-energized	Sustaining						

†Pressure Sustaining normally-open valve ("PSNO") for applications at filter stations.



AQUAMATIC END GUN CONTROL VALVE

The industry standard for years, these metal diaphragm valves are available from 3/4" through 4". These valves can be electrically or hydraulically activated. When ordering, please specify desired solenoid voltage if electric, and whether the valve will be mounted horizontally or vertically.

CONTROL VALVE WITH SOLENOID

Size	CV(1) 1 PSI LOSS@ GPM	Part No.	Price With Solenoid
3/4"	11.5	V42B-0000-00111	Call
1"	13	V42C-0000-00111	Call
1-1/4"	26.5	V42D-0001-00111	Call
1-1/2"	32.5	V42E-0001-00111	Call
*2"	56	V42F-0001-00111	Call
2.5 BODY, 2" MIPT	68	V42G-0001-00111	Call
2-1/2"	84	V42H-0001-00111	Call
3" FLG	135	V42J-3001-00111	Call
4" FLG	275	V42K-3001-00111	Call

CONTROL VALVE WITHOUT SOLENOID

Size	CV(1) 1 PSI LOSS@ GPM	Part No.	Price Without Solenoid
3/4"	11.5	V42B-0000-0000	Call
1"	13	V42C-0000-0000	Call
1-1/4"	26.5	V42D-0001-00100	Call
1-1/2"	32.5	V42E-0001-00100	Call
*2"	56	V42F-0001-00100	Call
2.5 BODY, 2" MIPT	68	V42G-0001-00100	Call
2-1/2"	84	V42H-0001-00100	Call
3" FLG	135	V42J-3001-00100	Call
4" FLG	275	V42K-3001-00100	Call

* 2" Valve available with solenoid in either a vertical (V) mount position or horizontal (H) mount position for proper endgun drainage to reduce the possibility of damage due to freezing. Specify either a vertical or horizontal valve when ordering.

NOTE: (1) All electric valves are equipped with a 110VAC solenoid unless otherwise specified.

(2) All valves are normally open (NO) unless otherwise specified.

(3) All valves are cast iron with buna seals & diaphragms unless otherwise specified.

(4) All valves larger than 1" are equipped with spring assist to open (SAO) and the #1 hole drilled and tapped to accept solenoid.

Call for "options" pricing. Options: normally closed, spring assist open, spring assist closed, Limit Stop, Viton Seals, Solenoids with 24VAC, 24VDC, 12VDC, 220VAC, Drill & Tap Bosses.

AQUAMATIC VALVE PARTS

Part No.	Description	Price
348BD	Strainer Assembly with Filter	Call
348Z	Solenoid Elbow (1/8" MIPT x 1/4" FIPT)	Call
421-C	3/4" and 1" Valve Cast Iron Cap	Call
424-C	1-1/4" and 1-1/2" Valve Cast Iron Cap	Call
425-C	2" Valve Cast Iron Cap	Call
425-RA	2" Valve Diaphragm Assembly	Call
Other parts and sizes available upon request		



3 WAY SOLENOIDS

Part No.	Description	Price
PKSOL-120UN	120 VAC Solenoid, Unpotted	\$116.52
PKSOL-120AC	120 VAC Solenoid, Potted	\$116.52
PKSOL-24AC	24 VAC Solenoid	\$139.08
PKSOL-24DC	24 VDC Solenoid	\$142.56
PKSOL-12DC	12 VDC Solenoid	\$139.08
PKSOL-12DCL	12 VDC Latching Solenoid	\$0.00



COILS

Part No.	Description	Price
PKHS	Coil Housing	\$52.03
PKCOIL-12DC	12 VDC Coil Only	\$66.70
PKCOIL-24DC	24 VDC Coil Only	\$66.70
PKCOIL-24AC	24 VAC Coil Only	\$66.70
PKCOIL-120AC	120 VAC Coil Only	\$64.80
PKPOT-120AC	120 VAC Coil with Housing, Potted	\$103.95



PUSH-IN FITTINGS & TUBING

Part No.	Description	Price
8970-005	1/4" Nylon Tube	\$1.00
8970-011	1/4" Tube x 1/4" Tube Connector Union Tee	\$14.09
8970-001	1/4" Tube x 1/8" MIPT Straight Connector	\$7.96
8970-008	1/4" Tube x 1/4" MIPT Straight Connector	\$8.19
8970-002	1/4" Tube x 1/8" MNPT Ell Connector	\$10.58
8970-006	1/4" Tube x 1/4" MNPT Ell Connector	\$11.46
8970-004	1/4" Tube x 1/8" MNPT Connector Tee	\$16.64
8970-007	1/4" Tube x 1/4" MNPT Connector Tee	\$16.64
8970-010	1/4" Tube x 1/8" MNPT Male Run Tee	\$16.73



END GUN BOOSTER PUMP

PIVOT END GUN BOOSTER PUMP & ACCESSORIES

This quality booster pump is built to meet the heavy-duty demands of its application. It is available as a 2HP model. No need to disturb pipe for normal maintenance. It has the same housing design as Berkley and will interchange with Berkley. Simply unbolt the old Berkley unit and replace it with the X-CAD model.

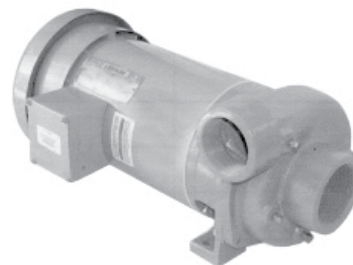

PIVOT END GUN BOOSTER PUMP

Part No.	Description	Price
BP2HP	2HP Booster Pump	\$1,004.53

PIVOT END GUN BOOSTER PUMP

Part No.	Description	Price
B85475	Berkeley 2 Hp	\$975.00



2-HP IRRIGATION BOOSTER PUMP MOTOR

Part No.	Description	Price
BPM2HP	2HP, 130 GPM, Motor Only	\$873.00



BOOSTER PUMP COMPONENTS

Part No.	Description	Price
BPVC	Volute Case	\$140.73
BPMBKT	Motor Bracket	\$130.60
BPIMP-SS	Stainless Steel Impeller	\$150.39
BPGSKT	Mylar Motor Gasket	\$3.61
BPCGSKT	Paper Motor Case Gasket	\$3.61
BPIMPSPC	Impeller Spacer	\$3.61
BPSEAL	Shaft Seal	\$23.28

PIVOT DRIVE COMPONENTS

TELESCOPING DRIVELINE WITH COUPLER ENDS

This is the ultimate time saving device. Typical installation requires 5-10 minutes. The telescoping feature makes lengths easily adjustable without having to cut driveshafts in the field. Heavy-duty materials and construction provides more durability than standard driveshafts. Made of square steel tube with 1" round ends for connection to gear boxes.

Part No.	Description	Price
PDLEXP	Telescoping Driveline w/Coupler Ends	\$91.08



UNIVERSAL STEEL DRIVELINE COUPLER

• One size fits all 3/4", 7/8" and 1" driveshafts • Flex in the disc eliminates shock on start up • No slack anyplace - takes jump out of gearboxes • Slotted 1" round end allows for tightening on worn shafts and prevents the U-Joint from freezing on the shaft • The disc is the only part that wears and it can be easily replaced • Clamps on to twisted driveshafts • Made with a milled angle for a tighter fit • Only 3 bolts and 5 nuts to tighten (stainless steel) • One 9/16" wrench fits everything • Longer lasting than aluminum couplers.

Part No.	Description	Price
U-JOINT-4.5	Universal Steel Driveline Coupler w/Large Disc	\$42.00
U-JOINT-3.5	Universal Steel Driveline Coupler w/Small Disc (Bell-Insert)	\$42.00
U-JOINT-DISC-LG	Large Disc for Steel U-Joint	\$10.64
U-JOINT-DISC-SM	Small Disc for Bell Insert	\$9.60
U-JOINT-BOLTKIT	Angle Bolt, Nuts, and Washers	\$6.00



DOUBLE ANGLE U-JOINT

This U-Joint is made for the 11.2 x 38 tires where there is a large amount of torque involved. They can also be used in place of the bell-insert U-Joint on any size of tire. They cannot be used when the driveline and gearbox are not in-line.

Part No.	Description	Price
U-JOINT-DBL-ANG	Double Angle U-Joint	Call
U-JOINTBELL02	Double Disc Bell Insert U-Joint	Call



UNIVERSAL U-JOINT

This U-Joint quickly attaches to both 3/4" and 7/8" driveshafts. Slotted 1" round end attaches to gearbox.

Part No.	Description	Price
PDLUNIV	Universal U-Joint for 3/4" or 7/8" Driveshafts	\$33.10



UMC ALUMINUM DRIVELINE COUPLERS

DRIVELINE COUPLERS WITH POLYURETHANE PUCK

Part No.	Description	Qty. 1-42	Qty. 43 +
01355-121J	1" RD. & 7/8" SQ. x 1-1/8" RD. & 1" SQ.	\$18.40	Call
01355-121M	1" RD. & 7/8" SQ. x 1" RD. & 7/8" SQ.	\$18.40	Call
01355-121P	1" RD. & 7/8" SQ. w/Key Slot x 3/4" SQ.	\$18.40	Call
01355-133A	Universal Drive Line Coupler Assy (CX Coupler)	\$26.00	Call
06550-704C	Polyurethane Replacement Pucks (Towable)	\$4.94	Call
06550-704D	Polyurethane Replacement Pucks (Non-Towable)	\$4.94	Call
06550-704C-G	Polyurethane Replacement Puck (CX Coupler)	\$4.94	Call



UMC TOWABLE HUB WITH PIN AND BRACKET ASSEMBLY

To convert the following non-tow wheel gearboxes into towable units, also order:

Part No.	Description	Price
04301-114A	BT-4 Bolt-on Towable Hub	Call
04041-102A	Tow Pin & Bracket Assembly	Call
04041-204A	1" Clip Assembly	Call
04041-203A	6" Tow Pin Only	Call
04040-401A	Bracket Only	Call

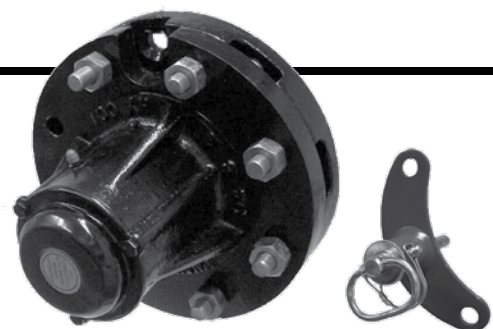

UMC FINAL DRIVE WHEEL GEARBOX

725 SERIES - OUR MOST POPULAR MODEL

- 50:1 (725U) gear ratio
- 2-1/4" output shaft
- extended length hub design allows greater bearing spacing to accommodate higher load requirements

- peak torque in excess of 69,000 in.-lbs.
- dual input seals
- high strength cast iron bolt-on end caps
- universal multimount bolt pattern



725TNT TOWABLE SERIES

- 50:1 (725UTNT) gear ratio
- 2-1/4" output shaft
- positive lock in both tow and non-tow positions

- easy to disengage for towing
- universal mount fits most systems
- lighter than standard towable units
- available with hydraulic adapter



740 SERIES

- 50:1 (740U), 52:1 (740UV), 52:1TNT (740UV-TNT) gear ratios available
- 2-1/4" output shaft
- heavy-duty worm input bearings
- extra heavy-duty wheel gearbox for heavier towers

- tested loads in excess of 125,000 in.-lbs.
- special crop guard seals on all shafts
- universal multimount bolt pattern



745 SERIES

- 50:1 (745U) gear ratio
- 2-1/2" output shaft
- high strength steel output shaft and forged worm

- input shaft guard included
- universal multimount bolt pattern
- available with towable hub



760 SERIES

- 50:1 (760U) gear ratio
- precision ground 2-1/2" output shaft
- dual output & input seal with external grease lube capabilities
- static load tested in excess of 145,000 in.-lbs.

- bolt pattern fits all pivots & lateral/linear systems
- includes A-110 bolt pattern
- full cycle expansion chamber
- optional bronze gear



Part No.	Description	Shaft Size	Gear Ratio	Type	Price
06147-105A	725U Universal Gearbox	2-1/4" Short	50:1	Non Tow	\$488.20
10140-110A	725U-TNT Gearbox	2-1/4" Short	50:1	Towable	\$678.10
10141-105A	740U Gearbox	2-1/4" Short	50:1	Non Tow	\$520.10
10141-106AD	740UV Gearbox	2-1/4" Extended	52:1	Non Tow	\$570.93
10141-135A	745U Gearbox	2-1/2" Short	50:1	Non Tow	\$0.00
10160-101A	760U Gearbox	2-1/2" Short	50:1	Non Tow	\$0.00

*No additional qty pricing.

UMC REPLACEMENT PARTS

These are the most commonly requested replacement parts for our UMC Final Drive Wheel Gearboxes. Other replacement parts, such as worm screws, gears, bearing, seals, etc., are available by special order and can be priced on request.

Part No.	Description	Price
06143-801A	Lug Bolt 9/16" - 18 x 1-5/8" Long	Call
04300-802A	Lug Bolt 9/16" - 18 x 1-7/8" Long	Call
06142-801A	Lug Nut 9/16" - 18	Call
06143-205D	Expansion Chamber Cover	Call
06143-704A	Expansion Chamber Diaphragm for 725U	Call



CENTER DRIVES & MOTORS

UMC CENTER DRIVE COMPONENTS

Part No.	Description	Price
09333-154A	56 C-Face Center Drive - 60:1	\$390.56
09333-151A	56 C-Face Center Drive - 50:1	\$390.56
09333-153A	56 C-Face Center Drive - 40:1	\$390.56
09333-152A	56 C-Face Center Drive - 30:1	\$390.56
06180-131A	1.5 HP C-Face Motor - 1725 RPM	\$542.50

UMC CENTER DRIVE POWER SAVER GEARBOX WITH MOTOR

Part No.	Description	Price
06168-101G	3/4 HP Power Saver - 60:1	Call
06168-101H	3/4 HP Power Saver - 50:1	\$599.98
06168-101A	3/4 HP Power Saver - 40:1	\$599.98
06168-101B	1.5 HP Power Saver - 30:1	\$713.80
06168-101D	1.5 HP Power Saver - 20:1	\$713.80

REPLACEMENT STATORS FOR POWER SAVERS

Part No.	Description	Price
06168-601A	Stator, .75 HP PS 3.5	\$369.89
06165-610A-I	Stator, .75 HP PS 3	\$389.78
06165-601B	Stator, 1.5 HP PS 3	\$410.68
06168-610B-I	Stator, 1.5 HP PS 3.5	\$410.68

*No additional qty pricing.

U.S. ELECTRICAL MOTORS CENTER DRIVE COMPONENTS

Part No.	Description	Type	Price
A726	1 HP Motor Module	Splined	\$480.00
A728	1.5 HP Motor Module	Splined	\$585.38
A732	58:1 Gear Module	Splined	\$539.60
A730	47:1 Gear Module	Splined	\$500.64
A800	31:1 Gear Module	Splined	\$516.08
7843	58:1/1HP Complete	Splined	Call
A856	47:1/1 HP Complete	Splined	\$748.00
A799	31:1/1.5 HP Complete	Splined	\$903.46
F295	1 HP Stator 5.5" Frame	Splined	Call
F296	1 HP Stator 6.5" Frame	Splined	Call
G148	1 HP Stator w/Endbell	Splined	Call
F470	1HP Motor Module	Tapered	Call
F465	58:1/1 HP Complete	Tapered	Call
F472	58:1 Gear Module	Tapered	Call
F473	47:1 Gear Module	Tapered	Call
F475	31:1 Gear Module	Tapered	Call
385371	58:1 Worm Shaft Conv. Kit	Tapered	Call
385372	47:1 Worm Shaft Conv. Kit	Tapered	Call
385374	31:1 Worm Shaft Conv. Kit	Tapered	Call
768887	1 HP/1140 RPM Motor	Wheel	Call
5622	1 HP/1800 RPM Motor	C-Face	Call
5624	1.5 HP/1800 RPM Motor	C-Face	Call

BLUFFTON MOTOR WORKS (FORMERLY FRANKLIN ELECTRIC)

Part No.	Description	Type	Price
UF12317	1-1/2 HP/1725 RPM Motor	C-Face	Call
UF17565	1 HP/1725 RPM Motor	C-Face	Call
UF17575	1 HP/1725 RPM Motor	Splined	Call

*No additional qty pricing.

ELECTRICAL COMPONENTS & ACCESSORIES

STRAIN RELIEF CORD CONNECTORS

Part No.	Description	Price
CG1850S	1/2" MIPT Metal Cord Connector, .250-.375	\$9.32
CG3775S	3/4" MIPT Metal Cord Connector, .375-.500	\$10.32
CG50100S	1" MIPT Metal Cord Connector, .500-.625	\$14.56
LPCG507	1/2" MIPT Plastic Cord Connector, .375-.750	\$6.65
LPCG757	3/4" MIPT Plastic Cord Connector, .375-.750	\$5.20
NMCG100875	1" MIPT Plastic Cord Connector, .750-.875	\$8.23



FUSES

FLNR 250 VAC, FLQ 500 VAC & CCMR 600 VAC FUSES

FLNR 250 VAC

Part No.	Description	Box Qty.	Price
FLNR4	4 AMP	10	\$6.00
FLNR10	10 AMP	10	\$5.55
FLNR15	15 AMP	10	\$4.61
FLNR20	20 AMP	10	\$4.61
FLNR30	30 AMP	10	\$4.61
FLNR35ID	35 AMP	10	\$8.80
FLNR40ID	40 AMP	10	Call
FLNR45ID	45 AMP	10	\$8.80
FLNR60ID	60 AMP	10	\$8.80
FLNR70ID	70 AMP	10	Call
FLNR80ID	80 AMP	5	Call
FLNR90ID	90 AMP	5	Call
FLNR100ID	100 AMP	10	\$19.65
FLNR200ID	200 AMP	1	\$46.34
FLNR300ID	300 AMP	1	\$81.81

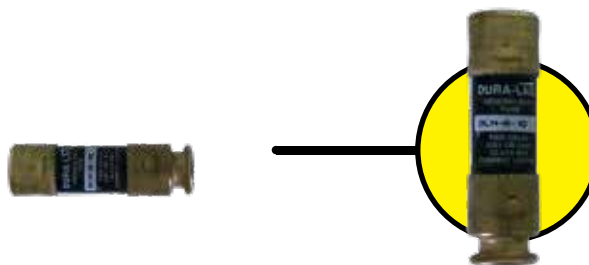

FLQ 500 VAC

Part No.	Description	Box Qty.	Price
FLQ1	1 AMP	10	\$4.08
FLQ1.125	1-1/8 AMP	10	\$4.08
FLQ2	2 AMP	10	\$4.08
FLQ2.25	2.25 AMP	10	\$4.08
FLQ2.5	2.5 AMP	10	\$4.08
FLQ3	3 AMP	10	\$4.16
FLQ3.2	3.2 AMP	10	\$4.08
FLQ4	4 AMP	10	\$4.08
FLQ5	5 AMP	10	\$4.08
FLQ5.6	5.6 AMP	10	Call
FLQ6	6 AMP	10	\$4.08
FLQ7	7 AMP	10	Call
FLQ8	8 AMP	10	\$4.08
FLQ9	9 AMP	10	Call
FLQ10	10 AMP	10	\$4.08
FLQ12	12 AMP	10	\$4.08
FLQ15	15 AMP	10	\$4.08
FLQ20	20 AMP	10	\$4.08
FLQ30	30 AMP	10	\$4.08

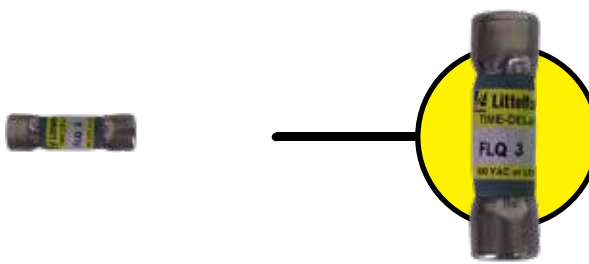

CCMR 600 VAC

Part No.	Description	Box Qty.	Price
CCMR1	1 AMP	10	\$9.76
CCMR2	2 AMP	10	\$9.76
CCMR2.5	2.5 AMP	10	\$9.76
CCMR3	3 AMP	10	\$9.76
CCMR4	4 AMP	10	\$9.76
CCMR5	5 AMP	10	\$9.76
CCMR6	6 AMP	10	\$9.76
CCMR8	8 AMP	10	\$9.76
CCMR10	10 AMP	10	\$9.76
CCMR15	15 AMP	10	\$9.76
CCMR20	20 AMP	10	\$9.76
CCMR25	25 AMP	10	\$9.76
CCMR30	30 AMP	10	\$9.76

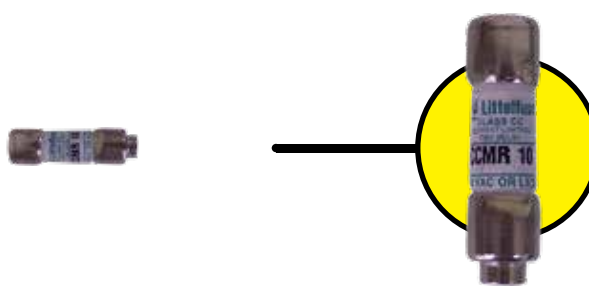

FLSR 600 VAC ID FUSES

FLSR 600 VAC ID

Part No.	Description	Box Qty.	Price
FLSR002ID	2 AMP ID	10	Call
FLSR003ID	3 AMP	10	\$5.07
FLSR004ID	4 AMP	10	\$5.07
FLSR005ID	5 AMP	10	\$5.07
FLSR05.6ID	5.6 AMP	10	Call
FLSR006ID	6 AMP	10	\$5.07
FLSR008ID	8 AMP	10	\$5.07
FLSR10ID	10 AMP ID	10	\$5.07
FLSR12ID	12 AMP	10	\$5.07
FLSR15ID	15 AMP	10	\$5.07
FLSR17ID	17 AMP	10	Call
FLSR17.5ID	17.5 AMP	10	\$5.07
FLSR20ID	20 AMP	10	\$5.07
FLSR25ID	25 AMP	10	\$5.07
FLSR30ID	30 AMP	10	\$6.67
FLSR35ID	35 AMP ID	10	\$6.67
FLSR40ID	40 AMP	10	\$6.67
FLSR45ID	45 AMP	10	\$6.67
FLSR50ID	50 AMP	10	\$6.67
FLSR60ID	60 AMP	10	\$6.67
FLSR70ID	70 AMP ID	10	\$13.76
FLSR80ID	80 AMP	5	\$13.76
FLSR90ID	90 AMP	5	\$13.76
FLSR100ID	100 AMP	5	\$13.76
FLSR110ID	110 AMP ID	5	\$27.20
FLSR125ID	125 AMP	1	\$27.20
FLSR150ID	150 AMP	1	\$27.20
FLSR175ID	175 AMP	1	\$27.20
FLSR200ID	200 AMP	1	\$27.20
FLSR225ID	225 AMP ID	1	\$137.36
FLSR250ID	250 AMP	1	\$137.36
FLSR300ID	300 AMP	1	\$137.36
FLSR350ID	350 AMP	1	\$137.36
FLSR400ID	400 AMP	1	\$137.36



JTD_ID 600 VAC (BOLT-IN)

Part No.	Description	Box Qty.	Price
OJTD-20-TXID	20 AMP	10	\$14.53
OJTD-25-TXID	25 AMP	10	\$14.53
OJTD-30-TXID	30 AMP	10	\$14.53
OJTD-35-TXID	35 AMP	10	\$23.76
OJTD-40-TXID	40 AMP	10	\$23.76
OJTD-45-TXID	45 AMP	10	\$23.76
OJTD-50-TXID	50 AMP	10	\$23.76
OJTD-60-TXID	60 AMP	10	\$23.76
OJTD-70-VXID	70 AMP	5	\$54.61
OJTD-80-VXID	80 AMP	5	\$54.61
OJTD-90-VXID	90 AMP	5	\$54.61
OJTD-100-VXID	100 AMP	5	\$54.61
OJTD-110-XXID	110 AMP	1	\$109.25
OJTD-125-XXID	125 AMP	1	\$109.25
OJTD-150-XXID	150 AMP	1	\$109.25
OJTD-175-XXID	175 AMP	1	\$109.25
OJTD-200-XXID	200 AMP	1	\$113.63
OJTD-225-XXID	225 AMP	1	\$211.09
OJTD-250-XXID	250 AMP	1	\$211.09
OJTD-300-XXID	300 AMP	1	\$211.09
OJTD-350-XXID	350 AMP	1	\$211.09
OJTD-400-XXID	400 AMP	1	\$211.09



TRANSFORMERS, SWITCHES & TIMERS

TRANSFORMERS

Part No.	Description	Price
9T58R3314	GE Transformer .530KVA 480/120,29 VAL 314977, ZIM 9-7666-2	\$219.12
9070T500Q28711	SQUARE D Transformer, .5KVA 460/120, 29 VAL; 314977, ZIM 9-7666-2	\$245.12
598	EDWARDS Transformer 120/ 8, 16, 24	\$66.38



PRESSURE SWITCHES AND PANEL METERS

Part No.	Description	Price
HZ19K964001	ASCO® Pressure Switch - ZIM, LW	\$347.60
HZ19K965-3	ASCO® Pressure Switch w/Enclosure, LW	\$468.34
250344SJSJ	GE/Yokogawa Voltmeter, 600V AC (Square)	\$40.00
T50B2	ENM Hour Meter, 115V	\$37.42

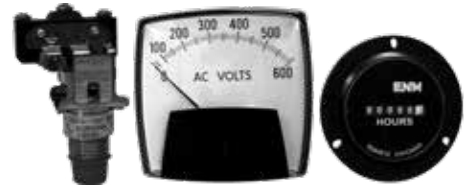

LIMIT SWITCHES, ACTUATORS & TOGGLE SWITCHES

Part No.	Description	Price
LSA3K	Limit Switch, Dbl, Brake, SPDT	\$224.00
LSK3K-8A	Limit Switch, Wisker	\$255.43
LSQ300	Limit Switch, Windmill 360°, SPDT	\$231.60
LSZ54N	Actuator Rod	\$28.50
LSZ51B	Roller Lever	\$22.61
900003	Toggle Switch On/Off, SPST	\$13.07
7592K8	Toggle Switch On/On, DPDT	\$10.61
1121-0014	Toggle Switch Off/On, DPDT, Spring Return	\$22.84
7563K6	Toggle Switch On/Off/On, DPDT, 3 Position	Call



PERCENTAGE AND OVERWATERING TIMERS

Part No.	Description	Price
322B014A22CS	ATC 10 Min., Overwatering, End Shut Down	\$340.27
322B050A22CS	ATC 10 Min., Overwatering, Stall, End Shut Down	\$340.27
BRE7A601	Solid State Reversing Reset Timer, 5 Min	\$170.60
BRE8A601	Solid State Reversing Reset Timer, 10 Min	\$170.60
BRE9A601	Solid State Reversing Reset Timer, 30 Min	\$170.60
BRE10A601	Solid State Reversing Reset Timer, 60 Min	\$170.60



MICRO SWITCHES

Part No.	Item	Description	Price
BZ-7RW80189-A2	1	MS, Short Arm Cam, LW L-640-076	\$17.37
BZ-2RW80147-P4	2	MS, Short Arm Cam, Side Terminal LW L640-00063	\$37.94
BZ-2RW80147-A2	3	MS, Short Arm Cam Old Lockwood L640-00148	\$19.82
BZ-2RQ18-A2	4	MS, Plunger, Roller VAL 314893, ZIM, LW	\$40.82
BZ-3RW8995516-PC2-S	5	MS, Short Arm Roller, Adj. Screw VAL 314905 (Replacement)	\$16.85
BZ-7RW82132T-S	6	MS, Long Arm Roller, ZIM 9-9030-9	\$20.69
BZ-7RW2T04	7	MS, Long Arm Roller, Pierce	\$49.22
BZ-2RW822-A2	8	MS, Short Arm Roller Gifford Hill, Tumac	\$18.74
BZ-3RW822-A2	9	MS, Short Arm Roller, Hydrus	\$18.00
BZ-2RW82255-A2-S	10	MS, Short Arm Roller, Reinke, Tumac	\$24.48
BZ-2RW8255-A2-S1	11	MS, Long Arm Roller, Zim Mini	Call

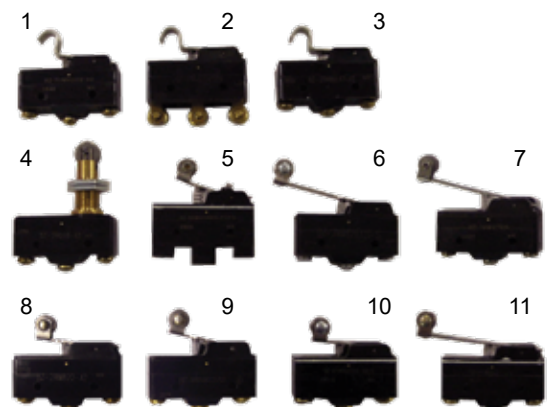

RELAYS

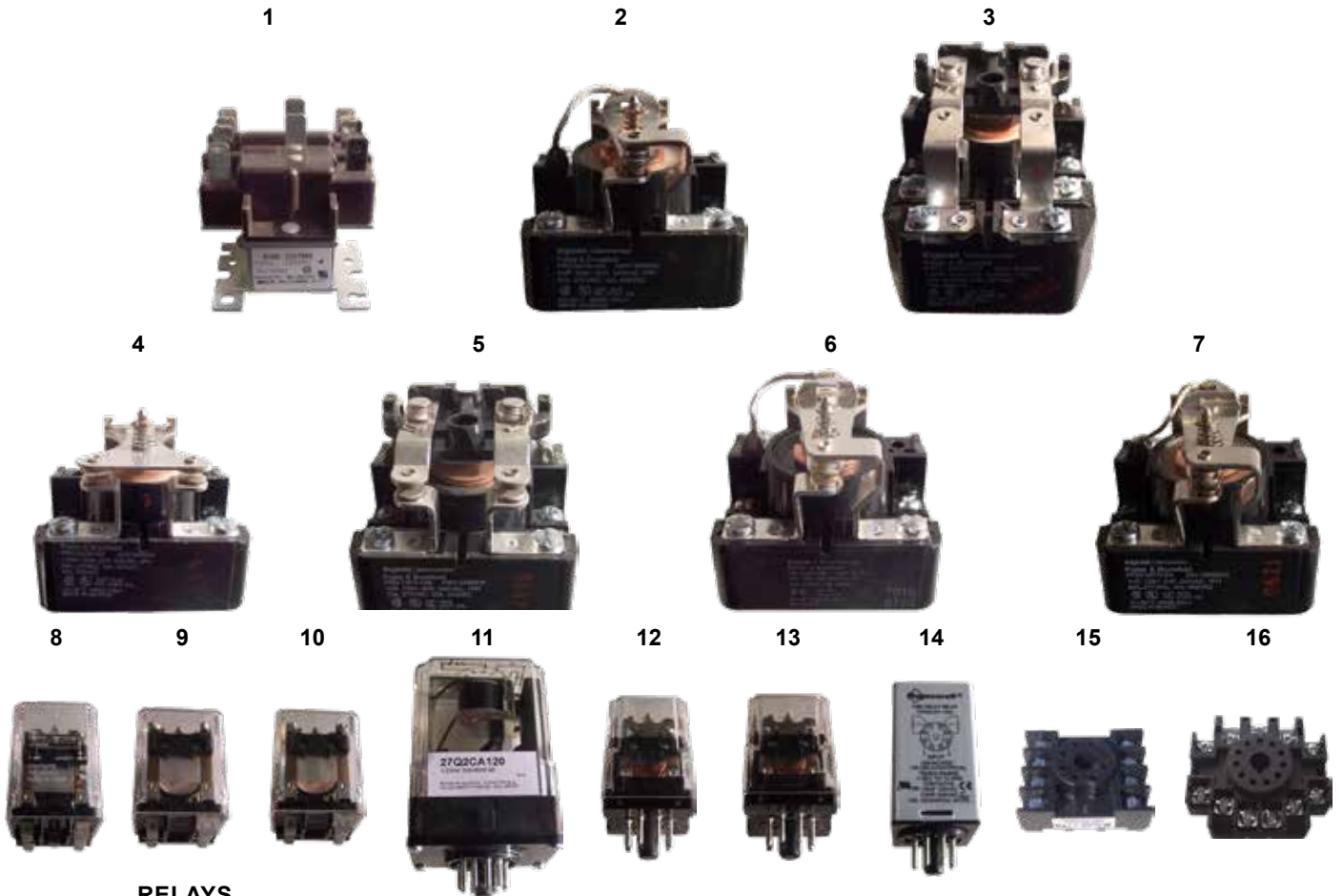

RELAYS

Part No.	Item	Description	Price
9100233T99	1	PU GENERAL PURPOSE RELAY, DPDT, 120 VAC	\$42.14
PRD5AYO480	2	P & B POWER RELAY, SPDT, 480VAC 50/60 HZ 25A 277VAC 1HP 120VAC 2HP 250VAC 10A 600VAC 7A 50VAC RESISTIVE	Call
PRD11AGO120VAC	3	P & B POWER RELAY, DPDT, 120VAC 50/60HZ 30A 240VAC 20A 277VAC 10A 600VAC VAL 314727	\$102.94
PRD3AGO120	4	P & B POWER RELAY, SPST, 120 VAC 50/60HZ, 30 A 277VAC RESISTIVE, 1.5HP 120VAC, 2 HP 250VAC, 10 AMP 600VAC	\$65.66
PRD7AYO120VAC	5	P & B POWER RELAY, DPST, 1HP - 120VAC 25A 240VAC 50/60HZ - ZIM9-9179-4	\$83.28
PRD5AYO120VAC	6	P & B POWER RELAY, SPDT, 120 VAC 50/60 HZ 25A 277VAC 10A 600VAC - ZIM 9-9142-2M	\$92.14
PRD5AYO24VAC	7	P & B POWER RELAY SPDT, 24VAC 50/60HZ 25A 277VAC 10A 240VAC - ZIM 9-8890-7	\$85.46
KUL11A15S120VAC	8	P & B ICE CUBE RELAY, 9 BLADE, 120VAC 50/60HZ 25A 277VAC 10A 600VAC - ZIM 10-0161-9	\$151.80
KUP11D15110VDC	9	P & B ICE CUBE RELAY, 8 BLADE, 110VDC 3A 600VAC 10A 240VAC - VAL 315559	\$32.11
KUP11D1512VDC	10	P & B ICE CUBE RELAY, 8 BLADE, 12 VDC COIL 1/3HP 120VAC 10A 240VAC VAL 099PO16, LW40-741	\$32.11
27Q2CA120	11	Eagle LATCHING RELAY, 11PIN - 120V 50/60 HZ 10A 120VAC RESISTIVE - ZIM 9-8955-8	\$183.20
KRPA11AN024VAC	12	P & B ICE CUBE RELAY, 8 PIN, 24VAC 50/60HZ 1/3HP 120VAC 1/2HP 10A 240VAC	Call
KRPA11AN120VAC	13	P & B ICE CUBE RELAY, 8 PIN, 120V 50/60 HZ 1/3HP 120VAC 1/2HP 10A 240VAC	Call
TDRSOXP120V	14	Magnecraft Time Delay Relay, 8 Pin, 120VAC/VDC Input Timing Range: .1 Sec to 10 Hrs. Contacts: 1/3HP 120VAC, 1/2HP 240VAC, 12A 120/240VAC 30VDC	Call
0T08PC	15	CUSTOM CONNECTOR SOCKET, 8 PIN	\$7.60
0T11PC	16	CUSTOM CONNECTOR SOCKET, 11 PIN	Call

CONTACTORS

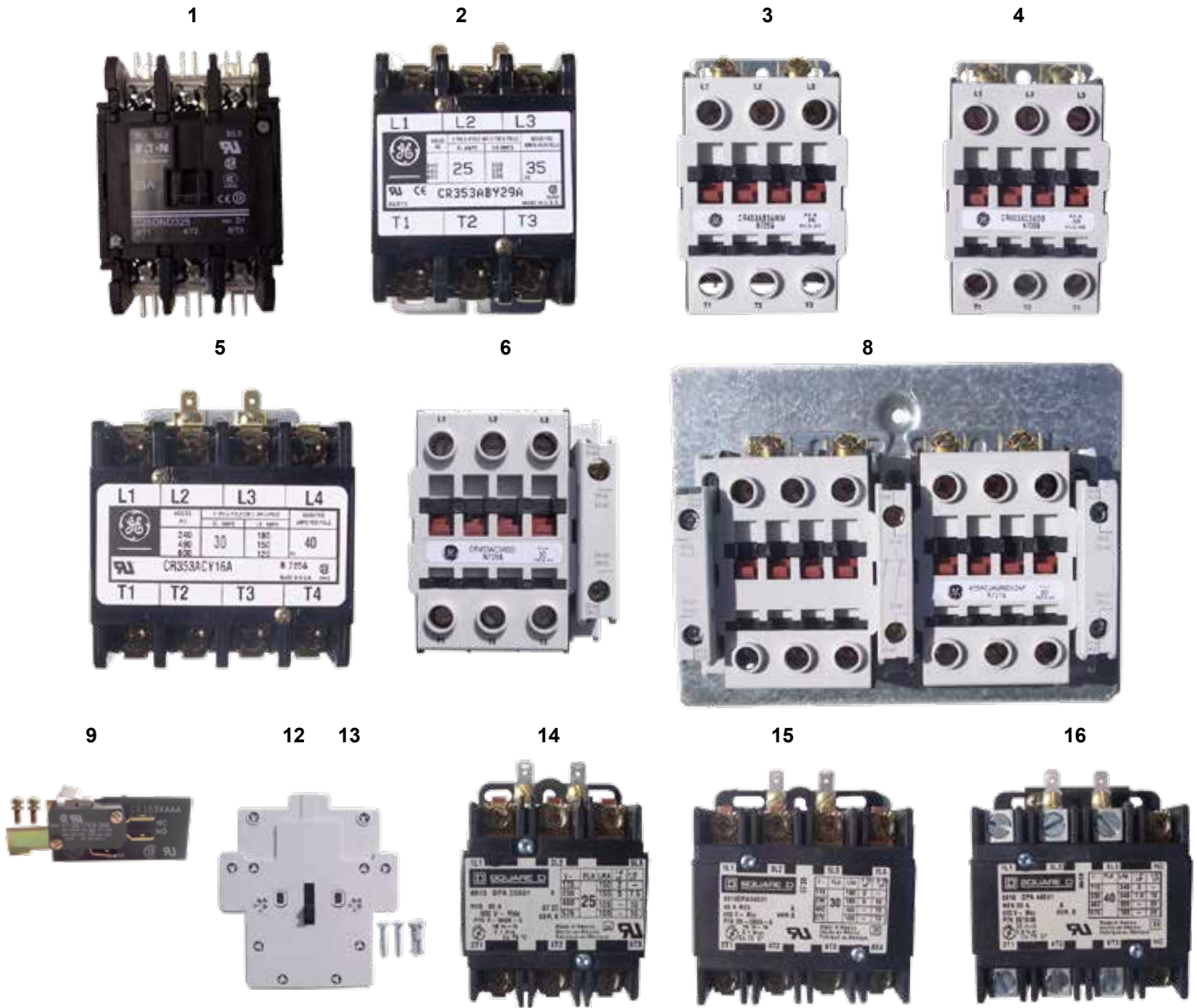

CONTACTORS

Part No.	Item	Description	Price
EAT-C25DND325A	1	Cutler Hammer 3 Pole Non-reversing Contactors, 25A, 110 - 120VAC	\$32.77
CR353ABY29A	2	GE 3 Pole Tower Contactor, 120VAC, 25 FL AMPS VAL 314667, ZIM 9-0866-5, LW L-40-246	\$58.08
LE-453AB3AMMP	3	GE 3 Pole Tower Contactor, 120VAC, 25 FL AMPS (New Style) VAL 314667, ZIM 9-0866-5, LW L-40-246	\$53.05
CR453AC3ADDP	4	GE 3 Pole W/Lugs Contactor, 120VAC, 30 FL AMPS (Replaces CR353AC3DA1) VAL 314598, LW L-40-602	\$68.94
CR353ACY16A	5	GE 4 Pole Panel Contactor, 120 VAC, 30 FL AMPS VAL 99P013, ZIM 9-0860-8	\$120.66
CR453AC3ADDP W/ BCLL11	6	GE 4 Pole Panel Contactor, 120VAC (Replaces CR353ACY16A) Add BCLL11 Side Mount Auxiliary Contact VAL 99P013, ZIM 9-0860-8	Call
CR355ACY7A	7	GE 4 Pole Reversing Contactor, 120VAC, ZIM 9-0864-0	Call
CR455AC3AMMD22FP	8	GE 4 Pole Reversing Contactor, 120VAC, 30 FL AMPS (Replaces CR355ACY7A) ZIM 9-0864-0	Call
CR353XAAA	9	GE 353 Series Side Mount Auxiliary Contact Block, 1NO - 1NC	\$19.28
BCLF10	10	GE 453 Series Front Mount Auxiliary Contact Block, 1NO	Call
BCLF01	11	GE 453 Series Front Mount Auxiliary Contact Block, 1NC	Call
BCLL11	12	GE 453 Series Side Mount Auxiliary Contact Block, 1NO-1NC	\$27.63
BCLL20	13	GE 453 Series Side Mount Auxiliary Contact Block, 2NO	\$25.71
8910DPA23S31	14	SD 3 Pole Tower Contactor, 120VAC, 25 FL AMPS, ZIM 9-0866-5	Call
8910DPA34S31	15	SD 4 Pole Panel Contactor, 120VAC, 30 FL AMPS, ZIM 9-0860-8	Call
8910DPA44S41	16	SD 4 Pole Panel Contactor, 120VAC, 40 FL AMPS, VAL 3E1848	\$120.80
LE-8910DPA44V02		SD 4 Pole Panel Contactor, 120VAC 40 FLAMPS, VAL3E1848	\$0.00

COLLECTOR RING AND ELECTRICAL ACCESSORIES

COLLECTOR RING

11 Wire Collector Ring

Replacements for all brands except ZIMMATIC®

Part No.	Description	Price
CA13235-11-LG	Insul 8 UL Approved (Room for Resolver Capability)	\$576.90



DELTA LIGHTNING ARRESTOR

Part No.	Description	Price
LA 301	125-250 Volt Single Phase 2 Wire Service	Call
LA 302	125-250 Volt Single Phase 3 Wire Service	Call
LA 302R	Light Duty 125-250 Volt Single Phase 3 Wire Service	Call
LA 303	250 Volt 3 Phase 3 or 4 Wire Service	Call



SUPPRESSOR, RECTIFIER, LIGHTNING ARRESTOR & HEATER

Part No.	Description	Price
STB02113265	Forked Arc Suppressor	\$8.57
58K8886	Rectifier, LWL-40-740	\$8.00
LA603MB	GE Lightning Arrester, 3 Pole 0-650V	\$130.80
123C356A	GE Overload Heater	Call



ALIGNMENT WIRE & ACCESSORIES

Part No.	Item	Description	Price
13GA1400FT	1	13 Gauge Wire - 1400' Reel (LW)	Call
L0003200217	2	1.5" x 26" Alignment Spring	Call
L0003200242	3	2.5" Spring for Alignment Wire	Call
L0004400319	4	Thimble 1/8" Safety & Alignment	Call
L0012100061	5	Ring, Spring Safety & Damper	Call
L0020300090	6	Center Bearing for Alignment Wire	Call
L0010100191	7	Fixing Nut for Alignment Wire	Call
L0004000463	8	Split Bolt Connector Safety Wire	Call
L0004000164	9	Insulator for Alignment Wire	Call



MISCELLANEOUS

PIVOT PIPE GASKET

Part No.	Description	Price
658TG	6-5/8" Pivot Pipe Flange Gasket	\$7.80



TOMAR PIVOT STROBE LIGHTS

485 MICRO STROBE EFFECTIVE CANDELA 50

Part No.	Description	Price
485S-A	1.75 Strobe Amber 120V	\$139.20
485S-B	1.75 Strobe Blue 120V	\$139.20
485S-C	1.75 Strobe Clear 120V	\$139.20
485S-G	1.75 Strobe Green 120V	\$139.20
485S-R	1.75 Strobe Red 120V	\$139.20
5001	Replacement Bulb	\$35.88
470S-L	Replacement Lens	\$28.92
Flash / Minute 60-80 Connection Screw in Socket		



490 MICRO STROBE EFFECTIVE CANDELA 50

Part No.	Description	Price
490S-A	1.75 Strobe Amber 120V	\$170.08
490S-B	1.75 Strobe Blue 120V	\$170.08
490S-C	1.75 Strobe Clear 120V	\$170.08
490S-G	1.75 Strobe Green 120V	\$170.08
490S-R	1.75 Strobe Red 120V	\$170.08
5001	Replacement Bulb	\$35.58
470S-L	Replacement Lens	\$28.92
Flash / Minute 60-80 Connection 1/2" FPT with leads		



801 MINI I EFFECTIVE CANDELA 400

Part No.	Description	Price
801-110-A	8 J Strobe Amber 120V	\$343.18
801-110-B	8 J Strobe Blue 120V	\$343.18
801-110-C	8 J Strobe Clear 120V	\$343.18
801-110-G	8 J Strobe Green 120V	\$343.18
801-110-R	8 J Strobe Red 120V	\$348.18
4001	Replacement Bulb for T801	\$103.22
801S-L	Replacement Lens	\$53.98
Available in VDC Flash / Minute 80-90 Connection 1/2" FPT		



824 MULTI PULSE EFFECTIVE CANDELA 1200

Part No.	Description	Price
824-110-A	23 J Strobe Amber 120V	\$714.00
824-110-B	23 J Strobe Blue 120V	\$714.00
824-110-C	23 J Strobe Clear 120V	\$714.00
824-110-G	23 J Strobe Green 120V	\$714.00
824-110-R	23 J Strobe Red 120V	\$714.00
4001	Replacement Bulb	\$103.22
1700	Replacement Lens	Call
Flash / Minute 120-240 Connection 1/2" FPT		



BOOT HOSE

NOVAFLEX 2150 BOOT HOSE 2PLY

Part No.	Size	Working PSI	Price / Ft.	Price / 100 Ft.
2150BE-04500-00	4-1/2"	100	Call	Call
2150BE-05000-00	5"	100	Call	Call
2150BE-05563-00	5-9/16"	100	Call	Call
2150BE-06000-00	6"	85	Call	Call
2150BE-06625-00	6-5/8"	75	Call	Call
2150BE-08000-00	8"	75	Call	Call
2150BE-08625-00	8-5/8"	75	Call	Call
2150BE-10000-00	10"	75	Call	Call



KURIYAMA T253AA BOOT HOSE 2 PLY 150 PSI

Part No.	Size	Price / Ft.	Price / 100 Ft.
T253AA150X100	1-1/2"	\$4.39	Call
T253AA200X100	2"	\$5.55	Call
T253AA300X100	3"	\$8.75	Call
T253AA400X100	4"	\$11.80	Call
T253AA600X100	6"	\$20.62	Call
T253AA662X100	6-5/8"	\$25.59	Call
T253AA800X100	8"	\$28.55	Call
T253AA1000X100	10"	\$48.22	Call
T253AA1200X100	12"	\$90.36	Call

Note: 12" is priced for 50 Ft. Roll. 12" Rated for 100 PSI



GOODYEAR® BOOT HOSE 4 PLY 150 PSI

Part No.	Size	Price / Ft.	Price / 50 Ft.
GY-BH-4-500	5"	Call	Call
GY-BH-4-600	6"	Call	Call
GY-BH-4-658	6-5/8"	Call	Call
GY-BH-4-800	8"	Call	Call
GY-BH-4-858	8-5/8"	Call	Call
GY-BH-4-1000	10"	Call	Call



GOODYEAR® BOOT HOSE 4 PLY 150 PSI (PRE-CUT)

Part No.	Size	Price
GY-BH-500-12	5" x 12"	\$22.96
GY-BH-600-16	6" x 16"	\$35.88
GY-BH-658-16	6-5/8" x 16"	\$37.80
GY-BH-658-18	6-5/8" x 18"	\$38.66
GY-BH-800-16	8" x 16"	\$52.17
GY-BH-858-12	8-5/8" x 12"	\$58.73
GY-BH-858-16	8-5/8" x 16"	\$67.12
GY-BH-1000-12	10" x 12"	\$66.48
GY-BH-1000-17	10" x 17"	\$94.18

Note: Additional Hose Selection Located in Section 3

TITAN® NEW TIRES, GALVANIZED WHEELS AND ASSEMBLIES

TITAN® NEW TIRES

Part No.	Size	Description	Price
483404	11.2 x 24	Titan Hi-Power Lug R-1 Tire 4 Ply	Call
483434	14.9 x 24	Titan Hi-Power Lug R-1 Tire 4 Ply	Call
483408	11.2 x 38	Titan Hi-Power Lug R-1 Tire 4 Ply	Call

TITAN® GALVANIZED WHEELS

Part No.	Size	Description	Price
051864800013G	8.25 x 22.5	Galvanized Wheel for 11 x 22.5 Recap Tire	Call
050777100013G	8.25 x 24.5	Galvanized Wheel for 11 x 24.5 Recap Tire	Call
050761600013G	10 x 24	Galvanized Wheel for 11.2 x 24 New Tire	Call
050803900013G	12 x 24	Galvanized Wheel -2.00 Degree Offset for 14.9 x 24 Tire	Call
050777200013G	12 x 24	Galvanized Wheel 0 Degree Offset for 14.9 x 24 Tire	Call
051130400013G	10 x 38	Galvanized Wheel Single Plate for 11.2 x 38 Tire	Call
051134600013G	10 x 38	Galvanized Wheel Double Plate for 11.2 x 38 Tire	Call
051119700013G	10 x 38	Galvanized Wheel 9 Hole TL for 11.2 x 38 Tire	Call



TITAN® TIRE & WHEEL ASSEMBLY

Part No.	Size	Description	Price
NT-112X24-GW	11.2 x 24	Assembly Without Tube	Call
NT-112X24-GR-TB	11.2 x 24	Assembly With Tube	Call
NT-149X24-GW	14.9 x 24	Assembly -2.00 Degree Offset Without Tube	Call
NT-149X24-GR-TB	14.9 x 24	Assembly -2.00 Degree Offset With Tube	Call
NT-149X24-GW-ZO	14.9 x 24	Assembly 0 Degree Offset Without Tube	Call
NT-149X24-ZO-TB	14.9 x 24	Assembly 0 Degree Offset With Tube	Call
NT-112X38-GR	11.2 x 38	Assembly Single Plate Wheel Without Tube	Call
NT-112X38-GR-TB	11.2 x 38	Assembly Single Plate Wheel With Tube	Call
NT-112X38-GR-DP	11.2 x 38	Assembly Double Plate Wheel Without Tube	Call
NT-112X38-DP-TB	11.2 x 38	Assembly Double Plate Wheel With Tube	Call
NT-112X38-GR-9H	11.2 x 38	Assembly 9 Hole TL Wheel Without Tube	Call
NT-112X38-TL-TB	11.2 x 38	Assembly 9 Hole TL Wheel With Tube	Call



IMPORT NEW TIRES AND ASSEMBLIES

IMPORT NEW TIRES

Part No.	Size	Description	Price
GH22	11.2 x 24	Import Tire 6 Ply	Call
GH62	14.9 x 24	Import Tire 6 Ply	Call
CMR130	11.2 x 38	Import Tire 6 Ply with Tube	Call

IMPORT TIRE & WHEEL ASSEMBLY

Part No.	Size	Description	Price
HT-112X24-GW	11.2 x 24	Assembly Without Tube	Call
HT-112X24-TB	11.2 x 24	Assembly With Tube	Call
HT-149X24-GW	14.9 x 24	Assembly -2.00 Degree Offset Without Tube	Call
HT-149X24-GW-TB	14.9 x 24	Assembly -2.00 Degree Offset With Tube	Call
HT-149X24-ZO	14.9 x 24	Assembly 0 Degree Offset Without Tube	Call
HT-149X24-ZO-TB	14.9 x 24	Assembly 0 Degree Offset With Tube	Call
HT-112X38-GW	11.2 x 38	Assembly Single Plate Wheel Without Tube	Call
HT-112X38-TB-S	11.2 x 38	Assembly Single Plate Wheel With Tube	Call
HT-112X38-DP	11.2 x 38	Assembly Double Plate Wheel Without Tube	Call
HT-112X38-DP-TB	11.2 x 38	Assembly Double Plate Wheel With Tube	Call
HT-112X38-9H	11.2 x 38	Assembly 9 Hole TL Wheel Without Tube	Call
HT-112X38-9H-TB	11.2 x 38	Assembly 9 Hole TL Wheel With Tube	Call



RECAPPED TIRES AND ASSEMBLIES

RECAPPED TIRES AND ASSEMBLIES

Part No.	Size	Description	Price
9800M	10 x 22	Recap Tire	Call
9800	10 x 22	Recap Tire	Call
9800M	11 x 22.5	Recap Tire	Call
9800	11 x 24.5	Recap Tire	Call
RT-11X225-GW	11 x 22.5	Assembly with Tire, Tube and Galvanized Wheel	Call
RT-11X245-GW	11 x 24.5	Assembly with Tire, Tube and Galvanized Wheel	Call



TUBES FOR NEW AND RECAPPED TIRES

Part No.	Size	Description	Price
3FM0ZK	7.5 / 8 / 9.5 x 24	Tube	Call
3FE60K	11 / 12 x 36 / 38	Tube	Call
3FE04K	13 / 14 X 24 / 26	Tube	Call

TIRES AND WHEEL ACCESSORIES

REINFORCING FLANGE

Part No.	Description	Price
WHLCNTR	Reinforcing Flange for Wheel Center	Call



NO SPIN LUG

Tower stuck? This successfully tested and field proven product, widely acclaimed by dealer and grower alike, is your solution to the problem. Uniquely designed and manufactured of steel to meet the rigorous demands of its heavy-duty application, yet lightweight - approximately 19 lbs. - making it easy to transport into the field where it can simply and easily be installed in seconds on either lead or trailing tire. Best results are obtained when two units are installed per tower - one on each tire - at 180 degree positioning, allowing for increased digging traction. Stays clean even in clay soils. Little or no maintenance required.

Tire Size	Regular Lug Style		Reversible Lug Style	
	Part No.	Price	Part No.	Price
11.2	NSL11	Call	NSL11R	Call
14.9	NSL14	Call	NSL14R	Call
16.9	NSL16	Call	NSL16R	Call



SERVICE SADDLES

BRONZE SADDLE FOR IPS PVC

Part No.	Pipe Size	Pipe OD	Outlet Size	Price
3401012075HC	1-1/4"	1.66"	3/4" FPT	Call
3401015075HC	1-1/2"	1.90"	3/4" FPT	Call
3401020100HE	2"	2.38"	1" FPT	Call
3401025100HE	2-1/2"	2.88"	1" FPT	Call
3401030200HK	3"	3.50"	2" FPT	Call
3401040200HK	4"	4.50"	2" FPT	Call
3401050100HE	5"	5.56"	1" FPT	Call
3401060200HK	6"	6.63"	2" FPT	Call
3401080200HK	8"	8.63"	2" FPT	Call
3401100200HK	10"	10.75"	2" FPT	Call
3401120200HK	12"	12.75"	2" FPT	Call



DUCTILE IRON SADDLE WITH BALE

Part No.	Pipe Size	Pipe OD Range	Outlet Size	Price
3411010100HE-DI	1"	1.31 - 1.39	1" FPT	\$38.14
3411015100HE-DI	1-1/4" - 1-1/2"	1.61 - 1.92	1" FPT	\$39.14
341102A100HE-DI	2"	2.38	1" FPT	\$45.29
3411025150HI-DI	2-1/4" - 2-1/2"	2.44 - 2.91	1-1/2" FPT	\$57.57
3411030125HI-DI	3"	2.97 - 3.54	1-1/2" FPT	\$61.43
3411034200HK-DI	3" - 4"	3.74 - 4.55	2" FPT	\$69.29
3411040200HK-D	4" - 5"	4.74 - 5.63	2" FPT	\$76.00
3411050200K-D	5" - 6"	5.94 - 6.70	2" FPT	\$84.29
341106B200HK-DI	6"	6.84 - 7.60	2" FPT	\$91.14
3411068200HK-DI	6" - 8"	7.69 - 8.72	2" FPT	\$99.57
3411030125HK-DI	8" - 10"	8.54 - 10.10	2" FPT	\$125.14
3411100200HK-DI	10" - 12"	10.64 - 12.12	2" FPT	\$139.00
3411120200HK-DI	12" - 14"	12.62 - 14.32	2" FPT	\$141.57



DUCTILE IRON SADDLE WITH BALES

Part No.	Pipe Size	Pipe OD Range	Outlet Size	Price
341302A150HI-D	2"	2.38" - 2.50"	1-1/2" FPT	\$60.43
341303B200HK-D	3"	3.45" - 4.05"	2" FPT	\$93.14
341304A200HK-D	4"	4.00" - 4.50"	2" FPT	\$96.86
341304C200HK-D	4"	4.74" - 5.14"	2" FPT	\$104.57
341306A200HK-D	6"	6.00" - 6.63"	2" FPT	\$108.43
341306B200HK-D	6"	6.84" - 7.64"	2" FPT	\$122.72
341308A200HK-D	8"	8.00" - 8.63"	2" FPT	\$131.14
341308B200HK-D	8"***	8.54" - 10.10"	2" FPT	\$135.57
341310A200HK-D	10"	10.00" - 11.10"	2" FPT	\$178.86
341310B200HK-D	10"	10.64" - 12.12"	2" FPT	\$178.86
341312A200HK-D	12"	12.00" - 13.20"	2" FPT	\$214.29
341312B200HK-D	12"	12.62" - 14.32"	2" FPT	\$214.29
34131214200HK-D	12" - 14"	14.73" - 15.65"	2" FPT	\$311.57
341316A200HK-D	16" - 18"	17.40" - 18.88"	2" FPT	\$389.14
341318A200HK-D	18"	19.50"	2" FPT	\$421.29
341320A200HK-D	20"	21.60"	2" FPT	\$470.71
341324A200HK-D	24"	25.80"	2" FPT	\$517.86



**Not to be used on IPS PVC

Other outlet sizes available

MCCROMETER FLOW METER

McCrometer flow meters are an economical choice for dependable flow measurement. The measuring device of this flow meter is a propeller, which when positioned in the center of the flowstream, will rotate at a velocity proportional to the velocity of the fluid moving through the flow meter. This rotation is transmitted mechanically to a register, and the fluid's volumetric flow rate and accumulated volume is then displayed via an instantaneous flow indicator and totalizer. The register case is hermetically sealed with a hinged lens cover and locking hasp. All McCrometer products are thoroughly tested and inspected during manufacture and prior to shipping. These meters require a minimum 5 diameters of straight pipe upstream and a minimum of 1 diameter of straight pipe downstream of the flow meter. Also required is a full pipeline of water for an accurate measurement. Although most installations are horizontally oriented, McCrometer flow meters can be specially ordered for vertical installation if needed. When properly ordered and installed, accuracy is guaranteed to be within + or - 2% of the actual flow.

- The model MO300 bolt-on saddle flow meter is our most popular and economical flow meter. It features a stainless steel saddle which eliminates the fatigue-related breakage common to cast iron and aluminum saddles and provides unsurpassed corrosion protection.
- The model ML100 irrigation flow meter is designed to provide accurate flow measurements at moderate pressure ratings in an inexpensive package. This low cost flanged tube meter is also a very popular selection, where a flanged connection is preferred.
- The model MF100 flanged meter features heavier steel construction which may be more desirable at higher operating pressures.

MO SERIES SADDLE METER

Bolt on Saddle Meter			Min. Flow	Max. Flow	(With Over Run Bearing)		
Part No.	Size	Price			Part No.	Size	Price
MO304	4"	\$1,886.64	50	600	MO304-OV	4"	Call
MO306	6"	\$1,980.72	90	1200	MO306-OV	6"	Call
MO308	8"	\$2,113.44	100	1500	MO308-OV	8"	Call
MO310	10"	\$2,283.12	125	1800	MO310-OV	10"	Call
MO312	12"	\$2,491.44	150	2500	MO312-OV	12"	Call

Note: Specify pipe ID, OD & wall thickness when ordering.

MF SERIES FLANGED METER 150 PSI WORKING PRESSURE

Part No.	Size	Min. Flow	Max. Flow	Description	Price
MF-102	2"	35	250	Flanged Flow Meter	\$1,890.00
MF-103	3"	35	250	Flanged Flow Meter	\$2,005.92
MF-104	4"	50	600	Flanged Flow Meter	\$2,138.64
MF-106	6"	90	1200	Flanged Flow Meter	\$2,662.80
MF-108	8"	100	1500	Flanged Flow Meter	\$3,210.48
MF-110	10"	125	1800	Flanged Flow Meter	\$4,089.12
MF-112	12"	150	2500	Flanged Flow Meter	Call

ML SERIES FLANGED METER 75 PSI WORKING PRESSURE

Part No.	Size	Min. Flow	Max. Flow	Description	Price
ML-106	6"	90	1200	Flanged Flow Meter	\$2,145.36
ML-108	8"	100	1500	Flanged Flow Meter	\$2,281.44
ML-110	10"	125	1800	Flanged Flow Meter	\$2,462.88
ML-112	12"	150	2500	Flanged Flow Meter	Call

OPTIONS

Part No.	Description	Price
CB100-00	Canopy Boot	Call
OT110	Over-Run Bearing Assembly	Call

NOTE: Purchase of canopy boot & over-run bearing extends warranty to 3 years.

Dial faces are available with either 1) gallons per minute indicator, totalizing in your choice of gallons, acre feet or acre inches, 2) cubic feet per second indicator, totalizing in acre feet, or 3) litres per second indicator totalizing in cubic feet.



Call for Volume Pricing

MCCROMETER VANES & FLOW TUBES

FS100 FLOW STRAIGHTENER

Part No.	OD	Wall Thickness	Price
FS106-1	6.625	0.08-0.199	Call
FS106-2	6.625	0.2-0.32	Call
FS106-3	6.0	0.08-0.156	Call
FS106-4	6.0	0.157-0.260	Call
FS108-1	8.625	0.08-0.209	Call
FS108-2	8.625	0.21-0.34	Call
FS108-3	8.0	0.08-0.161	Call
FS108-4	8.0	0.162-0.260	Call

The FS100 straightens flow so that accurate flow measurement can be achieved in limited space installations. The flow straightener features a fabricated stainless steel body which is easy to install and is an ideal accessory for the M0300 and M0300F series flow meters.

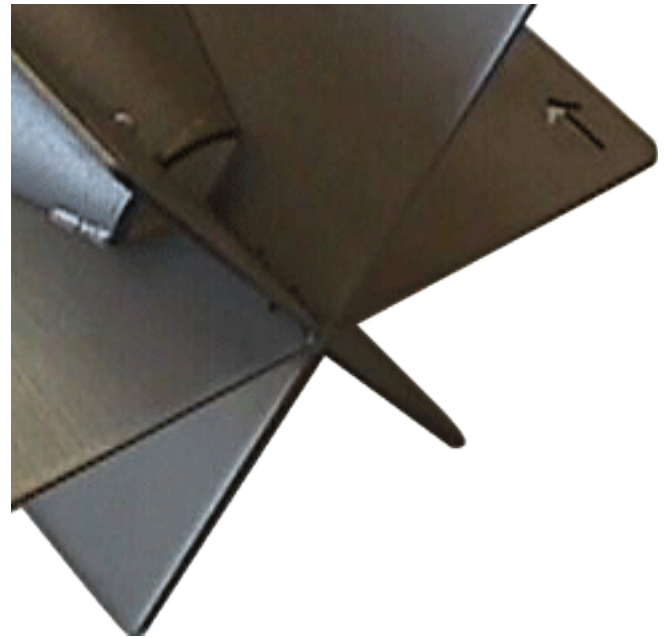

ALUMINUM WELD-IN VANES

Part No.	Size	Description	Price
TV804-AW	4"	Aluminum Weld-In Vane	Call
TV806-AW	6"	Aluminum Weld-In Vane	Call
TV808-AW	8"	Aluminum Weld-In Vane	Call
TV810-AW	10"	Aluminum Weld-In Vane	Call

STEEL WELD-IN VANES

Part No.	Size	Description	Price
TV804-SW	4"	Steel Weld-In Vane	Call
TV806-SW	6"	Steel Weld-In Vane	Call
TV808-SW	8"	Steel Weld-In Vane	Call
TV810-SW	10"	Steel Weld-In Vane	Call

BOLT-IN TRI VANES

Part No.	Size	Description	Price
TV804-SB	4"	Set of Three Tri Vane	Call
TV806-SB	6"	Set of Three Tri Vane	Call
TV808-SB	8"	Set of Three Tri Vane	Call
TV810-SB	10"	Set of Three Tri Vane	Call
TV812-SB	12"	Set of Three Tri Vane	Call

ALUMINUM FLOW TUBES WITH VANES		Without Weld Ring		With Weld Ring	
Size	Description	Part No.	Price	Part No.	Price
4"	Aluminum Flow Tubes	TA204-26RWRE4	Call	TA204-26KRWR4	Call
6"	Aluminum Flow Tubes	TA206-26KRRE6	Call	TA206-26KRWR6	Call
8"	Aluminum Flow Tubes	TA208-26KRRE6	Call	TA208-26KRWR6	Call
8"	Aluminum Flow Tubes 66" long	TA208-66KRRE6	Call	TA208-66KRWR6	Call
10"	Aluminum Flow Tubes	TA210-26KRRE6	Call	TA210-26KRWR6	Call
12"	Aluminum Flow Tubes	TA212-26HARE6	Call	TA212-26KRWR6	Call

OD STEEL FLOW TUBES WITH VANES		Plain End		Flanged	
Size	Description	Part No.	Price	Part No.	Price
4"	Steel Flow Tubes	TD104-26PEPE4	Call	TD204-26FLFL4	Call
6"	Steel Flow Tubes	TD106-26PEPE6	Call	TD206-26FLFL6	Call
8"	Steel Flow Tubes	TD108-26PEPE6	Call	TD208-26FLFL6	Call
8"	Steel Flow Tubes 30" Long	TD108-30PEPE6	Call	TD208-30FLFL6	Call
10"	Steel Flow Tubes	TD110-26PEPE6	Call	TD210-26FLFL6	Call
12"	Steel Flow Tubes	TD112-26PEPE6	Call	TD212-26FLFL6	Call

ID STEEL FLOW TUBES WITH VANES		Plain End		Flanged	
Size	Description	Part No.	Price	Part No.	Price
4"	Steel Flow Tubes	TO104-26PEPE4	Call	TO204-26FLFL4	Call
6"	Steel Flow Tubes	TO106-26PEPE6	Call	TO206-26FLFL6	Call
8"	Steel Flow Tubes	TO108-26PEPE6	Call	TO208-26FLFL6	Call
10"	Steel Flow Tubes	TO110-26PEPE6	Call	TO210-26FLFL6	Call

AIR & VACUUM RELIEF VALVES - PLASTIC

JAIN® AIR & VACUUM RELIEF VALVE

Part No.	Model No.	Description	Price
12090033	VBK-3/4	3/4" Air / Vacuum Relief Valve	\$14.21
12090023	VBK-1	1" Air / Vacuum Relief Valve	\$14.21
12090028	VBKV-1	1" Air / Vacuum Relief Valve w/Shrader	\$19.28



Part No.	Model No.	Description	Price
12090001	APV-1	1" Air / Vacuum Relief Valve	\$21.85
12090004	APV-1-1/4	1-1/4" Air / Vacuum Relief Valve	\$46.01
12090002	APV-1-1/2	1-1/2" Air / Vacuum Relief Valve	\$77.64
12090007	APV-2	2" Air / Vacuum Relief Valve	\$81.52
12090010	APVV-1	1" Air / Vacuum Relief Valve w/Shrader	\$27.97
12090013	APVV-1-1/4	1-1/4" Air / Vacuum Relief Valve w/Shrader	\$52.13
12090011	APVV-1-1/2	1-1/2" Air / Vacuum Relief Valve w/Shrader	\$83.76
12090016	APVV-2	2" Air / Vacuum Relief Valve w/Shrader	\$83.76



Part No.	Model No.	Description	Price
12090057	ARV-1	1" Continuous Acting Air Relief Valve	\$106.56
12090020	ARV-2	2" Continuous Acting Air Relief Valve	\$212.99



NELSON AIR & VACUUM RELIEF VALVE

Part No.	Model No.	Description	Price
9672-003	ACV-200P	2" Continuous Acting Air / Vacuum Relief Valve	\$150.00



AIR & VACUUM RELIEF VALVES

AIR & VACUUM RELIEF VALVES - ALUMINUM

Part No.	Size	Description	Price
F030-20003	2"	Fresno Air Vent & Vacuum Relief Valve	\$39.60
F030-30003	3"	Fresno Air Vent & Vacuum Relief Valve	\$82.80
F030-40003	4"	Fresno Air Vent & Vacuum Relief Valve	\$163.20



Part No.	Size	Description	Price
AV150	1-1/2"	Travis Air Vent & Vacuum Relief Valve	\$32.82
IAV200	2"	Travis Air Vent & Vacuum Relief Valve	\$21.06
AV300	3"	Travis Air Vent & Vacuum Relief Valve	\$72.94



CONTINUOUS ACTING AIR & VACUUM RELIEF VALVES - ALUMINUM

Part No.	Size	Description	Price
F035-20000	2"	Fresno Continuous Acting Air & Vacuum Relief Valve	\$261.60
F035-30000	3"	Fresno Continuous Acting Air & Vacuum Relief Valve	\$295.20
F035-40000	4"	Fresno Continuous Acting Air & Vacuum Relief Valve	\$369.60



PRESSURE RELIEF VALVES - SPRING LOADED TYPE

Part. No.	Size	Pressure Range	Description	Price
F031-22050A-XXX	2" FPT	0 - 70 PSI	Fresno PR-600A Pressure Relief	\$175.20
F031-22052A-XXX	2" FPT	71 - 120 PSI	Fresno PR-600A Pressure Relief	\$175.20
F031-27050A-XXX	2-1/2" FPT	0 - 70 PSI	Fresno PR-600A Pressure Relief	\$177.60
F031-27052A-XXX	2-1/2" FPT	71 - 120 PSI	Fresno PR-600A Pressure Relief	\$177.60
F031-32050A-XXX	3" FPT	0 - 60 PSI	Fresno PR-600A Pressure Relief	\$218.40
F031-32052A-XXX	3" FPT	61 - 120 PSI	Fresno PR-600A Pressure Relief	\$218.40
F031-42050A-XXX	4" FPT	0 - 50 PSI	Fresno PR-600A Pressure Relief	\$273.60
F031-42052A-XXX	4" FPT	51 - 120 PSI	Fresno PR-600A Pressure Relief	\$273.60

XXX - SPECIFY 22, 50, 80, 100, OR 125 PSI SETTING



Part. No.	Size	Pressure Range	Description	Price
F031-32010-XXX	3" FPT	0 - 50 PSI	Fresno PR-900 Pressure Relief w/Cover	\$249.60
F031-32012-XXX	3" FPT	51 - 100 PSI	Fresno PR-900 Pressure Relief w/Cover	\$249.60
F031-32013-XXX	3" FPT	101 - 150 PSI	Fresno PR-900 Pressure Relief w/Cover	\$285.60
F031-42010-XXX	4" FPT	0 - 45 PSI	Fresno PR-900 Pressure Relief w/Cover	\$312.00
F031-42012-XXX	4" FPT	46 - 130 PSI	Fresno PR-900 Pressure Relief w/Cover	\$321.60
F031-42013-XXX	4" FPT	131 - 150 PSI	Fresno PR-900 Pressure Relief w/Cover	\$355.20
F031-62010-XXX	6" FPT	0 - 50 PSI	Fresno PR-900 Pressure Relief w/Cover	\$717.60
F031-62011-XXX	6" FPT	51 - 90 PSI	Fresno PR-900 Pressure Relief w/Cover	\$717.60
F031-62012-XXX	6" FPT	91-120 PSI	Fresno PR-900 Pressure Relief w/Cover	\$864.00

XXX - SPECIFY 22, 50, 80, 100, OR 125 PSI SETTING



Part. No.	Size	Pressure Setting	Description	Price
P3221-60	3" FPT	80 PSI	Pierce Pressure Relief Valve	\$144.00
P3221-85	3" FPT	85 PSI	Pierce Pressure Relief Valve	\$144.00
P3226-20	3" FPT	120 PSI	Pierce Pressure Relief Valve	\$144.00
P1730-60	3" FPT	60 PSI	Pierce Pressure Relief Valve	\$115.20
P1730-85	3" MPT	85 PSI	Pierce Pressure Relief Valve	\$115.20
P1732-20	3" MPT	120 PSI	Pierce Pressure Relief Valve	\$115.20



PRESSURE RELIEF VALVES

PRESSURE RELIEF VALVES - SPRING LOADED TYPE

Part. No.	Size	Pressure Range	Description	Price
SEP-4325-80	3" FPT	0 - 80 PSI	Travis Pressure Relief Valve	\$197.33



Part. No.	Size	Pressure Range	Description	Price
HY-TAV-101	3" FPT	0 - 50 PSI	Tri Action Vacuum, Air & Pressure Relief	\$590.80
HY-TAV-100	3" FPT	50 - 160 PSI	Tri Action Vacuum, Air & Pressure Relief	\$584.40



Part. No.	Size	Pressure Range	Description	Price
PRV2GA-XXX	2" FPT	0-25	XCAD Pressure Relief Valve Gray Spring	\$155.10
PRV2YA-XXX	2" FPT	30-40	XCAD Pressure Relief Valve Yellow Spring	\$146.60
PRV2BA-XXX	2" FPT	45-90	XCAD Pressure Relief Valve Black Spring	\$132.90
PRV2YBA-XXX	2" FPT	95-150	XCAD Pressure Relief Valve Yel/Blu Spring	\$168.90

Part. No.	Size	Pressure Range	Description	Price
PRV2.5GA-XXX	2.5" FPT	0-25	XCAD Pressure Relief Valve Gray Spring	\$155.10
PRV2.5YA-XXX	2.5" FPT	30-40	XCAD Pressure Relief Valve Yellow Spring	\$146.60
PRV2.5BA-XXX	2.5" FPT	45-90	XCAD Pressure Relief Valve Black Spring	\$132.90
PRV2.5YBA-XXX	2.5" FPT	95-150	XCAD Pressure Relief Valve Yel/Blu Spring	\$168.90

Part. No.	Size	Pressure Range	Description	Price
PRV3GA-XXX	3" FPT	0-25	XCAD Pressure Relief Valve Gray Spring	\$155.10
PRV3YA-XXX	3" FPT	30-40	XCAD Pressure Relief Valve Yellow Spring	\$146.60
PRV3BA-XXX	3" FPT	45-90	XCAD Pressure Relief Valve Black Spring	\$132.90
PRV3YBA-XXX	3" FPT	95-150	XCAD Pressure Relief Valve Yel/Blu Spring	\$168.90

Part. No.	Size	Pressure Range	Description	Price
PRV4GA-XXX	4" FPT	0-25	XCAD Pressure Relief Valve Gray Spring	\$195.70
PRV4YA-XXX	4" FPT	30-40	XCAD Pressure Relief Valve Yellow Spring	\$207.40
PRV4BA-XXX	4" FPT	45-90	XCAD Pressure Relief Valve Black Spring	\$191.80
PRV4YBA-XXX	4" FPT	95-150	XCAD Pressure Relief Valve Yel/Blu Spring	\$222.40



XCAD PRESSURE RELIEF VALVES ARE CIT TESTED
 XXX - SPECIFY 22, 50, 80, 100, OR 125 PSI SETTING
 PERFORMANCE OF INDIVIDUAL VALVES MAY VARY SLIGHTLY DUE TO SPRING VARIATIONS
 95-150 PSI RATING TAKES TWO SPRINGS YELLOW AND BLUE
 FACTORY SET

MATCO BUTTERFLY VALVES

WAFER - DUCTILE DISC - LEVER

Size	Part No.	Price
2"	B5-RLO2	\$80.11
2-1/2"	B5-RLO2.5	\$91.16
3"	B5-RLO3	\$75.43
4"	B5-RLO4	\$75.05
5"	B5-RLO5	\$175.45
6"	B5-RLO6	\$138.28
8"	B5-RLO8	\$180.33
10"	B5-RLO10	\$345.71
12"	B5-RLO12	\$455.71



WAFER - DUCTILE DISC - GEAR

Size	Part No.	Price
2-1/2"	B5-RWG2.5	\$133.57
3"	B5-RWG3	\$144.57
4"	B5-RWG4	\$139.87
5"	B5-RWG5	\$232.90
6"	B5-RWG6	\$173.12
8"	B5-RWG8	\$295.00
10"	B5-RWG10	\$378.52
12"	B5-RWG12	\$504.80
14"	B5-RWG14	\$1,125.14



WAFER - STAINLESS DISC - LEVER

Size	Part No.	Price
2"	B5-RLO2S	\$97.17
2-1/2"	B5-RLO2.5S	\$114.31
3"	B5-RLO3S	\$132.86
4"	B5-RLO4S	\$197.06
5"	B5-RLO5S	\$275.79
6"	B5-RLO6S	\$294.11
8"	B5-RLO8S	\$503.03
10"	B5-RLO10S	\$929.15
12"	B5-RLO12S	\$1,021.00



WAFER - STAINLESS DISC - GEAR

Size	Part No.	Price
3"	B5-RWG3S	\$223.07
4"	B5-RWG4S	\$245.17
5"	B5-RWG5S	\$326.60
6"	B5-RWG6S	\$396.03
8"	B5-RWG8S	\$664.41
10"	B5-RWG10S	\$1,014.95
12"	B5-RWG12S	\$1,332.25
14"	B5-RWG14S	\$2,098.32
16"	B5-RWG16S	\$3,261.15



LUG - DUCTILE DISC - LEVER

Size	Part No.	Price
2"	B5-LGL2	\$88.08
2-1/2"	B5-LGL2.5	\$97.40
3"	B5-LGL3	\$109.18
4"	B5-LGL4	\$155.42
5"	B5-LGL5	\$197.04
6"	B5-LGL6	\$228.88
8"	B5-LGL8	\$339.22
10"	B5-LGL10	\$478.74
12"	B5-LGL12	\$611.68



LUG - DUCTILE DISC - GEAR

Size	Part No.	Price
2"	B5-LGG2	\$145.77
2-1/2"	B5-LGG2.5	\$160.21
3"	B5-LGG3	\$172.04
4"	B5-LGG4	\$210.15
5"	B5-LGG5	\$253.48
6"	B5-LGG6	\$285.67
8"	B5-LGG8	\$425.15
10"	B5-LGG10	\$528.62
12"	B5-LGG12	\$718.40



MATCO BUTTERFLY VALVES

PVC LEVER

Size	Part No.	Price
2"	B1-RL02	\$157.90
2-1/2"	B1-RL02.5	\$174.43
3"	B1-RL03	\$200.97
4"	B1-RL04	\$258.39
6"	B1-RL06	\$444.90



PVC GEAR

Size	Part No.	Price
8"	B1-RWG8	\$1,047.82
10"	B1-RWG10	\$1,684.00
12"	B1-RWG12	\$1,940.41



BUTTERFLY EXTENSIONS



MATCO EXTENSIONS

Valve Size	Extension									
	Part No.	24"	Part No.	36"	Part No.	48"	Part No.	60"	Part No.	72"
2" - 3"	B5-X24-A	\$142.47	B5-X36-A	\$148.66	B5-X48-A	\$153.26	B5-X60-A	\$167.25	B5-X72-A	\$185.84
4"	B5-X24-B	\$142.47	B5-X36-B	\$148.66	B5-X48-B	\$177.05	B5-X60-B	\$188.92	B5-X72-B	\$235.85
5" - 6"	B5-X24-C	\$142.47	B5-X36-C	\$148.66	B5-X48-C	\$177.05	B5-X60-C	\$206.42	B5-X72-C	\$235.85
8"	B5-X24-D	\$213.00	B5-X36-D	\$236.66	B5-X48-D	\$260.06	B5-X60-D	\$283.99	B5-X72-D	\$283.39
10"	B5-X24-E	\$213.00	B5-X36-E	\$236.66	B5-X48-E	\$260.32	B5-X60-E	\$283.99	B5-X72-E	\$307.66
12"	B5-X24-F	\$213.00	B5-X36-F	\$236.66	B5-X48-F	\$260.32	B5-X60-F	\$283.99	B5-X72-F	\$307.66
14"	B5-X24-G	\$283.39	B5-X36-G	\$306.52	B5-X48-G	\$342.18	B5-X60-G	\$365.98	B5-X72-G	\$400.93
16"	B5-X24-H	CALL	B5-X36-H	CALL	B5-X48-H	\$466.02	B5-X60-H	\$566.07	B5-X72-H	\$596.20



FRESNO EXTENSIONS

Valve Size	Extension									
	Part No.	24"	Part No.	36"	Part No.	48"	Part No.	60"	Part No.	72"
2" - 6"	F084-E020-024	\$182.40	F084-E020-036	\$201.60	F084-E020-048	\$216.00	F084-E020-060	\$234.00	F084-E020-072	\$252.00
8" - 12"	F084-E080-024	\$222.00	F084-E080-036	\$240.00	F084-E080-048	\$259.20	F084-E080-060	\$280.80	F084-E080-072	\$302.40
14" - 16"	F084-E140-024	\$522.00	F084-E140-036	\$549.60	F084-E140-048	\$578.40	F084-E140-060	\$604.80	F084-E140-072	\$634.80

BUTTERFLY ACCESSORIES

LEVERS, GEAR BOXES, ELECTRIC ACTUATORS

Valve Size	Valve Brand	Lever Handle w / Lock Plate	Price	Gear Box w / Hand Wheel	Price	Electric Actuator	Price
2" - 3"	Matco	B5L3-LP	Call	B5G23	Call	P1-120N4	Call
	Grinnell			221819020801000	Call		
	Grayline			F084-020-70-HW	Call		
4"	Matco	B5L4-LP	Call	B5G4	Call	WSA-MATCO4	Call
	Grinnell			221819020801000	Call		
	Grayline			F084-020-70-HW	Call		
5"	Matco	B5L6-LP	Call	B5G56	Call	RCEL009ALSA120	Call
	Grinnell			221819020801000	Call		
	Grayline			F084-020-70-HW	Call		
6"	Matco	B5L6-LP	Call	B5G56	Call	WSA-MATCO6	Call
	Grinnell			221819020801000	Call		
	Grayline			F084-020-70-HW	Call		
8"	Matco	B5L8-LP	Call	B5G8	Call	WSA-MATCO8	Call
	Grinnell			221819080801000	Call		
	Grayline			F084-080-70-HW	Call		
10"	Matco	B5L10-LP	Call	B5G10	Call	P4-120N4	Call
	Grinnell			221819080801000	Call		
	Grayline			F084-080-70-HW	Call		
12"	Matco	B5L12-LP	Call	B5G12	Call	P4-120N4	Call
	Grinnell			221819120801000	Call		
	Grayline			F084-080-70-HW	Call		
14"	Matco	-	-	B5G14	Call	P4-120N4.5	Call
	Grinnell	-	-	221819140601000	Call		
	Grayline	-	-	F084-140-70-HW	Call		
16"	Matco	-	-	B5G16	Call	P4-120N4.5	Call
	Grinnell	-	-	221819140601000	Call		
	Grayline	-	-	F084-140-70-HW	Call		



NOTE: Grayline actuator part numbers and price are for 110 volt single phase.
 Grayline actuators based on 50PSI working pressure. Please advise if actual operating pressure exceeds 50PSI.
 Grinnell actuators are universal voltage covering a range from 24 to 240 volts AC or DC, 1 phase 50/100 HZ.

CAST IRON & PVC FLANGES

CAST IRON THREADED COMPANION FLANGE

Size	Galvanized	Price	Black	Price
2"	CICFG08	\$22.31	\$14.90	\$16.38
2-1/2"	CICFG09	\$31.10	\$17.53	\$19.28
3"	CICFG10	\$36.91	\$23.18	\$25.49
4"	CICFG11	\$52.72	\$31.03	\$34.14
5"	CICFG12	\$75.87	\$60.42	\$66.46
6"	CICFG13	\$85.16	\$49.89	\$54.88
8"	CICFG14	\$126.46	\$77.60	\$85.36

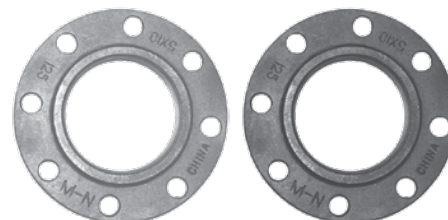

Intro 1 - Pivot 2 - Valves 3 - Surface 4 - IPS Epoxy / Galv. 5 - Sudipn Fittings 6 - PVC Fittings 7 - Sprinklers 8 - Malleable 9 - Hose 10 - Injectors / Filters 11 - Low Volume Formulas / TC

BUTTERFLY VALVE ACCESSORIES

CARBON STEEL FLANGES

CARBON STEEL 1/2" PLATE FLANGES

Size	OD Pipe Size		IPS Pipe Size		Blind	
	Part No.	Price	Part No.	Price	Part No.	Price
2"	DAL-PFH0200-16	\$7.57	DAL-PF0200	Call	DAL-PFBH0200	Call
2-1/2"	DAL-PFH0250-16	\$9.54	DAL-PF0250	Call	DAL-PFBH0250	Call
3"	DAL-PFH0300-16	\$10.08	DAL-PFH0300	\$9.80	DAL-PFBH0300	\$10.40
4"	DAL-PFH0400-16	\$13.65	DAL-PFH0400	\$13.45	DAL-PFBH0400	\$20.54
5"	DAL-PFH0500-16	\$21.20	DAL-PFH0500	\$13.77	DAL-PFBH0500	\$26.86
6"	DAL-PFH0600-16	\$17.50	DAL-PFH0600	\$16.63	DAL-PFBH0600	\$30.77
8"	DAL-PFH0800-16	\$25.26	DAL-PFH0800	\$23.03	DAL-PFBH0800	\$47.86
10"	DAL-PFH1000-16	\$33.94	DAL-PFH1000	\$31.09	DAL-PFBH1000	\$63.37
12"	DAL-PFH1200-16	CALL	DAL-PFH1200	Call	DAL-PFBH1200	\$92.89
14"	DAL-PFH1400	CALL	-	-	DAL-PFBH1400	Call
16"	DAL-PFH1600	CALL	-	-	DAL-PFBH1600	Call



PVC GASKETS

PVC VAN STONE STYLE FLANGE

Size	IPS Pipe Size				
	Part No.	Price	Size	Part No.	Price
2"	854-020	\$14.80	8"	854-080	\$90.66
2-1/2"	854-025	\$22.86	10"	854-100	\$180.19
3"	854-030	\$25.26	12"	854-120	\$194.05
4"	854-040	\$31.95	14"	854-140	\$1,102.76
5"	854-050	\$50.27	16"	854-160	\$1,475.00
6"	854-060	\$50.27			



FLANGE GASKETS

FULL FACED RED RUBBER FLANGE GASKET

Size	1/8" Thick	
	Part No.	Price
2"	CO-APR-606	\$1.68
2-1/2"	CO-APR-607	\$2.17
3"	CO-APR-608	\$1.83
4"	CO-PAR-609	\$3.58
5"	CO-APR-610	\$4.48
6"	CO-APR-611	\$5.34
8"	CO-APR-612	\$8.10
10"	CO-APR-613	\$11.31
12"	CO-APR-614	\$15.94
14"	CO-APR-615	Call
16"	CO-APR-616	\$17.87



GASKET, NUT & BOLT SETS

NUT AND BOLT SET

Size	Steel x BFV x Steel		PVC x BFV x PVC		Steel x BFV x PVC	
	Part No.	Price	Part No.	Price	Part No.	Price
2" - 4"	NBS5/8X4	Call	NBS5/8X5	Call	NBS5/8X5	Call
5" - 6"	NBS3/4X4.5	Call	NBS3/4X6	Call	NBS3/4X5	Call
8"	NBS3/4X4.5	Call	NBS3/4X6	Call	NBS3/4X5	Call
10" - 12"	NBS7/8X5	Call	NBS7/8X7.5	Call	NBS7/8X7.5	Call

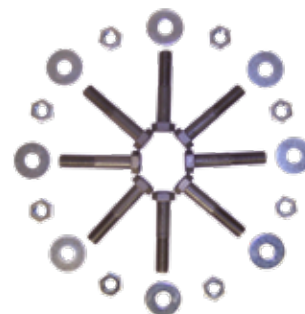

Please call for nut & bolt size recommendations for lug style butterfly valves & flange combinations.

BUTTERFLY LINE VALVES

PLAIN END BUTTERFLY LINE VALVES



TRAVIS

Part No.	Size	Price
BV400	4"	\$293.58
BV600	6"	\$359.58
BV800	8"	\$456.86
BV1000	10"	\$643.96



PIERCE

Part No.	Size	Price
P1800-01	4"	\$230.40
P1801-01	5"	\$249.60
P1802-01	6"	\$292.80
P1803-01	8"	\$357.60
P1804-01	10"	\$506.40

BAND & LATCH BUTTERFLY LINE VALVES



TRAVIS

Part No.	Size	Price
BLSBV400	4"	\$351.06
BLSBV600	6"	\$433.04
BLSBV800	8"	\$588.41
BLSBV1000	10"	\$884.66

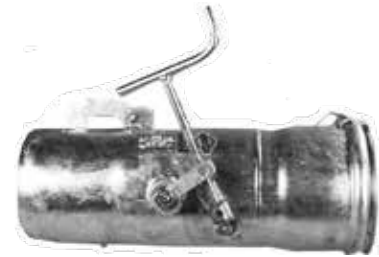

PIERCE

Part No.	Size	Price
P1812-61	4"	\$273.60
P1813-61	5"	\$300.00
P1814-61	6"	\$352.80
P1815-61	8"	\$477.60

RING LOCK BUTTERFLY LINE VALVES

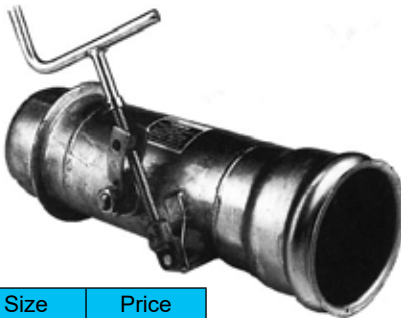

TRAVIS

Part No.	Size	Price
SRLBV400	4"	\$301.06
SRLBV600	6"	\$347.88
SRLBV800	8"	\$490.35
SRLBV1000	10"	\$788.09
SRLBV1200	12"	\$961.93



PIERCE

Part No.	Size	Price
P1821-61	4"	\$247.20
P1822-61	5"	\$297.60
P1823-61	6"	\$328.80
P1824-61	8"	\$451.20
P1825-61	10"	\$648.00
P1826-61	12"	\$794.40

FLANGED BUTTERFLY LINE VALVES

TRAVIS

Part No.	Size	Price
BVFL400	4"	\$403.34
BVFL600	6"	\$463.51
BVFL800	8"	\$588.41
BVFL1000	10"	\$903.35

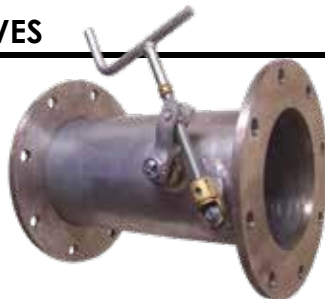

BALL VALVES

BRASS BALL VALVES

MATCO FULL PORT BALL VALVE

Part No.	Size	Price
759T01	1/4"	\$6.82
759T03	1/2"	\$8.05
759T04	3/4"	\$11.88
759T05	1"	\$18.86
759T06	1-1/4"	\$28.82
759T07	1-1/2"	\$41.20
759T08	2"	\$69.83
759T09	2-1/2"	\$167.26
759T10	3"	\$226.98
759T11	4"	\$387.61



PLASTIC BALL VALVE

BANJO FULL PORT (THREADED)

Part No.	Size	Price
V050	1/2"	Call
V075	3/4"	Call
V100FP	1"	Call
V125FP	1-1/4"	Call
V150	1-1/2"	Call
V200FP	2"	Call
V300FP	3"	Call



BANJO STANDARD PORT (THREADED)

Part No.	Size	Price
V100	1"	Call
V125	1-1/4"	Call
V200	2"	Call
V300	3"	Call
V400	4"	Call



SOUTHERN VALVE (THREADED OR SOCKET)

Size	Threaded Part No.	Price	Socket Part No.	Price
1/2"	SV-400-005T	\$1.59	SV-400-005S	\$1.59
3/4"	SV-400-007T	\$2.24	SV-400-007S	\$2.24
1"	SV-400-010T	\$3.23	SV-400-010S	\$3.23
1-1/4"	SV-400-012T	\$4.45	SV-400-012S	\$4.45
1-1/2"	SV-400-015T	\$6.16	SV-400-015S	\$6.16
2"	SV-400-020T	\$8.88	SV-400-020S	\$8.88
2-1/2"	SV-400-025T	\$27.78	SV-400-025S	\$27.78
3"	SV-400-030T	\$42.34	SV-400-030S	\$42.34
4"	SV-400-040T	\$71.10	SV-400-040S	\$71.10



CAST IRON GATE VALVES

MATCO FLANGED GATE VALVE - CAST IRON

Part No.	Size	Price
10RW10	3"	\$380.25
10RW11	4"	\$554.29
10RW12	5"	\$728.36
10RW13	6"	\$885.83
10RW14	8"	\$1,361.54
10RW15	10"	\$2,159.75
10RW16	12"	\$3,355.80



MATCO THREADED GATE VALVE - CAST IRON

Part No.	Size	Price
10RS08	2"	\$315.92
10RS09	2-1/2"	\$416.84
10RS10	3"	\$490.36
10RS11	4"	\$576.87
10RS12	5"	\$805.14
10RS13	6"	\$925.46
10RS14	8"	Call



MATCO RING-TITE GATE VALVE - CAST IRON

Part No.	Size	Price
10RT10	3"	\$460.71
10RT11	4"	\$559.72
10RT13	6"	\$802.21
10RT14	8"	\$1,381.93



BRASS GATE VALVES

MATCO BRASS GATE VALVE

Part No.	Size	Price
514T01	1/4"	\$15.45
514T03	1/2"	\$9.49
514T04	3/4"	\$12.06
514T05	1"	\$18.09
514T06	1-1/4"	\$25.09
514T07	1-1/2"	\$31.26
514T08	2"	\$49.51
514T09	2-1/2"	\$93.97
514T10	3"	\$122.37
514T11	4"	\$196.83



CHECK VALVES



MATCO BRASS SWING CHECK VALVE

Part No.	Weight Lbs.	Size	Price
521T03	.43	1/2"	\$9.19
521T04	.62	3/4"	\$11.91
521T05	.80	1"	\$16.23
521T06	1.35	1-1/4"	\$27.70
521T07	1.67	1-1/2"	\$34.36
521T08	2.78	2"	\$54.67
521T09	4.90	2-1/2"	\$95.36
521T10	5.35	3"	\$167.43
521T11	6.37	4"	\$279.08

MATCO CAST IRON WAFER CHECK VALVE

Part No.	Weight Lbs.	Size	Price
CVC-3	8	3"	\$153.75
CVC-4	12	4"	\$196.80
CVC-5	19	5"	\$226.00
CVC-6	21	6"	\$295.18
CVC-8	34	8"	\$468.91
CVC-10	56	10"	\$606.01
CVC-12	71	12"	\$897.09

CONTROL VALVES

NELSON 800 SERIES CONTROL VALVES



As a hydraulically operated sleeve-type valve, the 800 Series Control Valve is designed for versatility. The basic body can be equipped with several different options for controlling pressure and flow in piping systems ranging from drip irrigation to center pivot end guns. It's also engineered for extremely high efficiency, resulting in low pressure loss and high flow capacity.

The MANUAL ON-OFF model of the 800 Series Control Valve is a hydraulically operated sleeve type valve with a manual control function.

The ELECTRIC ON-OFF model of the 800 Series Control Valve is a hydraulically operated sleeve type valve with an electric solenoid control.



Pressure control valves react or respond through a pressure control regulator.

The basic 800 Series Control Valve body can be equipped with several different control packages in various combinations for controlling pressure and flow in large piping systems.

The Nelson 800 Series valve can be equipped with the Rate-Of-Flow (Model D18) control to regulate the flow rate passing through the valve.

TO ORDER: Select one option from each of the five sections to build the valve description code and price.

Section	1. Size/Material/Connections	2. Pressure	3. Pressure Control	4. On/Off Control	5. Filter
Code	A6 B5	C3	D01	D01	H3
Description	6" Cast Iron Wafer w/Stud Kit	Medium (18-80 psi)	None	Manual Selector Only	Internal Filter
List Price = \$1535	\$1,369	\$0	\$0	\$75	\$91

1. Size/Material/Connections			
Code	Material	Connections	List Price
A2 B3	Cast Iron	2" Threaded (NPT)	\$487
A2 B6		2" Victaulic	\$469
A2 B9	Aluminum	Wafer (no stud kit)	\$315
A2 B10		Wafer w/ stud kit for 2" Flanges	\$393
A2 B17		Wafer w/ stud kit for 75/100 Big Gun	\$386
3" Valves			
A3 B6	Cast Iron	3" Victaulic	\$731
A3 B9	Aluminum	Wafer (no stud kit)	\$533
A3 B10		Wafer w/ stud kit for 3" Flanges	\$616
A3 B17		Wafer w/ stud kit for 150 Big Gun	\$609
4" Valves			
A4 B4	Cast Iron	Wafer (no stud kit)	\$905
A4 B5		Wafer w/ stud kit for 4" Flanges	\$993
A4 B21		Wafer 6x4x6 (no stud kit)	\$1,015
A4 B22		Wafer 6x4x6 w/ stud kit	\$1,131
A4 B9	Aluminum	Wafer (no stud kit)	\$742
A4 B10		Wafer w/ stud kit for 4" Flanges	\$830
A4 B17		Wafer w/ stud kit for 200 Big Gun	\$826
A4 B23		Wafer 6x4x6 (no stud kit)	\$852
A4 B24		Wafer 6x4x6 w/ stud kit	\$968
6" Valves			
A6 B4	Cast Iron	Wafer (no stud kit)	\$1,253
A6 B5		Wafer w/ stud kit for 6" Flanges	\$1,369
A6 B21		Wafer 8x6x8 (no stud kit)	\$1,433
A6 B22		Wafer 8x6x8 w/ stud kit	\$1,587
8" Valves			
A8 B4	Cast Iron	Wafer (no stud kit)	\$2,531
A8 B5		Wafer w/ stud kit for 8" Flanges	\$2,685

2. Pressure		
Code	Operating Pressure	List Price
C1	Low (10-50 psi)	\$0
C2	High (30-200 psi)	\$0
C3	Medium (18-80 psi)	\$0

3. Pressure Control		
Code	ADJ. Range	List Price
D01	None	-
Pressure Reducing		
D02	5-30 psi, 4-8"	\$750
D03	5-60 psi, 4-8"	
D04	10-120 psi, 4-8"	
D11	5-30 psi, 2" & 3"	\$406
D12	5-60 psi, 2" & 3"	
D13	10-120 psi, 2" & 3"	
Pressure Sustaining		
D05	25-200 psi, 4-8"	\$750
D08	10-120 psi, 4-8"	
D09	5-60 psi, 4-8"	
D15	5-60 psi, 2" & 3"	\$406
D16	10-120 psi, 2" & 3"	
Rate of Flow		
D18-1	3" Pipe, 120-400 gpm	\$715
D18-2	4" Pipe, 200-550 gpm	
D18-3	6" Pipe, 350-1000 gpm	
D18-4	6" Pipe, 500-2000 gpm	
D18-5	8" Pipe, 500-1550 gpm	
D18-6	8" Pipe, 900-3800 gpm	
Sleeve Exhaust		
D06	Valve open below 30 psi	\$527
D06-1	Valve open below 10 psi	
Shuttle Check		
D07	Shuttle Check	\$130

D18 SPECIFY GPM

4. On/Off Controls*		
Code	ADJ. Range	List Price
E00	None	-
E01	Manual Selector Only	\$75
Manual Selector with Solenoid		
E11	E11 Solenoid - 12 VDC, 1.6mm, NC†	\$254
E20	E20 Window+ Controller, 1.6mm (4-8")	\$458
E21	E21 Solenoid - 12 VDC, 1.6mm	\$550
E23	E23 Solenoid - 9-12 VDC Lat., 1.2mm	\$173
E25	E25 Solenoid - 12 VDC, 3.2mm, NC†	\$466
E29	E29 Solenoid - 12-40 VDC Lat., 2.0mm	\$256
E30	E30 Solenoid - 24 VDC, 1.6mm	\$350
E31	E31 Window+ Controller, 1.2mm (2" & 3")	\$377
E34	E34 Solenoid - 24 VDC, 1.2mm	\$201
E40	E40 Solenoid - 24 VAC, 1.6mm, 2.5W	\$210
E41	E41 Solenoid - 24 VAC, 1.6mm, 8W	\$334
E43	E43 Solenoid - 24 VAC, 1.2mm, 3W	\$173
E46	E46 Solenoid - 24 VAC, 1.6mm, 5.5W	\$210
E50	E50 Solenoid - 120 VAC, 1.6mm, 8W	\$334
E52	E52 Solenoid - 120 VAC, 3.2mm, 17W	\$571
E53	E53 Solenoid - 110 VAC, 1.6mm, 5.5W	\$252

5. Filter		
Code	Filter	List Price
H2	External Filter	\$152
H3	Internal Filter (2" & 3")	\$64
	Internal Filter (4-8")	\$91
Filter with Tubing Protection		
H4	External Filter	\$206
H5	Internal Filter (2" & 3")	\$119
	Internal Filter (4-8")	\$146

SPECIFY VALVE SIZE



*Contact Factory for full solenoid specifications.

Other models available for special order.

†Normally closed solenoid for pressure sustaining, normally open valve ("PSNO") for applications at filter stations.

CLOSED: Upstream water is applied to the outer sleeve chamber, the sleeve becomes hydraulically balanced & the flow passage is closed off by the sleeve pressing against the center seat.

OPEN: Water pressure is relieved from the sleeve chamber, allowing the valve to open.

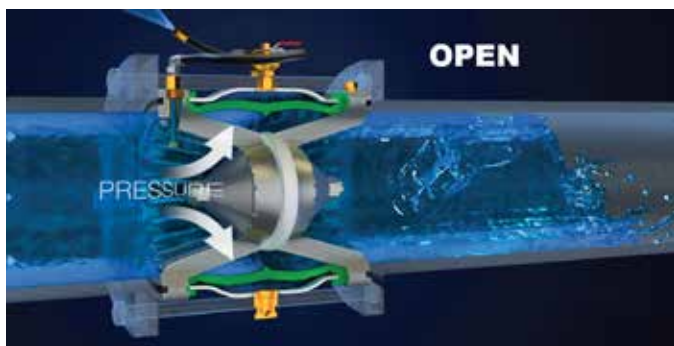

Nelson Control Valves come standard normally closed.

Use the following codes to specify non-standard, normally open, or special solenoid plumbing logic.

Optional Solenoid Logic											
Solenoid Only			Sustaining w/ Solenoid			Reducing w/ Solenoid			Sustaining/Reducing w/ Solenoid		
Code	Solenoid Status	Valve Status	Code	Solenoid Status	Valve Status	Code	Solenoid Status	Valve Status	Code	Solenoid Status	Valve Status
L02	Energized	Closed	L03	Energized	Sustaining	L08	Energized	Closed	L09	Energized	Sustaining-Reducing
	De-energized	Open		De-energized	Closed		De-energized	Open		De-energized	Closed
			L04 †	Energized	Sustaining				L10	Energized	Sustaining
				De-energized	Open					De-energized	Reducing
			L05	Energized	Closed				L11	Energized	Reducing
				De-energized	Sustaining					De-energized	Sustaining
			L06	Energized	Open						
				De-energized	Sustaining						

†Pressure Sustaining normally-open valve ("PSNO") for applications at filter stations.

Surface

Section 3

4	CHECK VALVES
5	CHEMIGATION VALVES
6-11	BAND & LATCH FITTINGS
12	WELD-ON FITTINGS - GALVANIZED STARTER COUPLERS
13-14	RING LOCK FITTINGS - GALVANIZED STEEL
14	RING LOCK FITTINGS - BLACK STEEL
15-18	WELD-ON FITTINGS - BLACK
19	BLACK BUTT WELD FITTINGS
20-21	GALVANIZED STEEL RINGLOCK FITTINGS
22	STEEL HOSE BARB FITTINGS
23	BOLTED COUPLER
23	THREADED DISCHARGE ADAPTERS
24	FLANGE DISCHARGE ADAPTERS
25	GALVANIZED FITTINGS
26-27	VALVE OPENERS - GALVANIZED
28	VALVE OPENERS - GALV, EPOXY, & ALUMINUM
29	VALVE OPENERS - ALUMINUM
30-31	VALVE OPENER REPAIR PARTS
32-33	VALVE STUBS - GALVANIZED
34	VALVE STUBS - ALUMINUM
35-36	VALVE STUB REPAIR PARTS
37	ALUMINUM BAND & LATCH MAINLINE FITTINGS
37	ALUMINUM BAND & LATCH GATED PIPE COUPLERS
38-41	ALUMINUM BAND & LATCH LATERAL LINE FITTINGS
42-43	ALUMINUM BAND & LATCH SOLID SET FITTINGS
44	BAND & LATCH PARTS & ACCESSORIES
45	ALUMINUM BAND & LATCH MAINLINE FITTINGS
46-48	ALUMINUM RING LOCK FITTINGS
48	STEEL RING LOCK FITTINGS
49	ALUMINUM TWIST LOCK FITTINGS
49	HOLD BANDS & REPAIR SLEEVES
50-51	WELD-ON FITTINGS - ALUMINUM
51	LOW PRESSURE ALUMINUM HOSE BARB FITTINGS
52	STEEL HOSE BARB FITTINGS
53-56	BALL & SOCKET FITTINGS
57-65	GASKETS



TRAVIS GALVANIZED CHECK VALVES

FLANGED

Part No.	Size	Price
CKVFL4	4"	\$273.65
CKVFL6	6"	\$389.84
CKVFL8	8"	\$460.82
CKVFL10	10"	\$515.96



PLAIN END

Part No.	Size	Price
CKVP4	4"	\$273.65
CKVP6	6"	\$389.84
CKVP8	8"	\$460.82
CKVP10	10"	\$515.69



PIERCE GALVANIZED CHECK VALVES

FLANGED

Part No.	Size	Price
P1755-01	4"	\$319.20
P1753-01	6"	\$372.00
P1753-02	8"	\$468.00
P1753-03	10"	\$561.60
P3797-01	12"	\$1,039.20
P0051-26	14"	\$1,693.00



PLAIN END

Part No.	Size	Price
P1752-05	3"	\$225.60
P1754-01	4"	\$237.60
P0033-01	5"	Call
P1752-01	6"	\$273.60
P1752-02	8"	\$343.20
P1752-03	10"	\$424.80
P3859-01	12"	\$705.60



PIERCE GALVANIZED CHEMIGATION CHECK VALVES

FLANGED

Part No.	Size	Price
P1775-61	4"	\$504.00
P1778-61	6"	\$597.60
P1778-62	8"	\$693.60
P1778-63	10"	\$852.00
P3645-61	12" x 10" x 12"	Call
P1778-64	12"	\$1,404.00



WEDGE-TITE®

Part No.	Size	Price
P0035-72	4"	Call
P3649-01	6"	\$657.60
P3650-01	8"	\$813.60
P3651-01	10"	\$955.20



TRAVIS GALVANIZED CHEMIGATION CHECK VALVES

FLANGED

Part No.	Size	Price
CHEMVFL4	4"	\$592.49
CHEMVFL6	6"	\$684.66
CHEMVFL8	8"	\$816.33
CHEMVFL10	10"	\$982.21



BOLT TITE

Part No.	Size	Price
CHEMVBT4	4"	Call
CHEMVBT6	6"	Call
CHEMVBT8	8"	Call
CHEMVBT10	10"	Call



PVC CHEMIGATION DRAIN CHECK VALVE

CHEMIGATION POPPET DRAIN CHECK VALVE

Part No.	Size	Price
TR-3/4 Drain	1" MIPT Inlet x 3/4" MGHT Outlet	\$20.59



GALVANIZED STEEL BAND & LATCH FITTINGS

PRESS-ON LATERAL COUPLER SET



PIERCE

Part No.	Size	Outlet	Price
P1016-81	2"	3/4"	\$45.30
P1898-81	3"	3/4"	\$38.70
P1016-83	4"	3/4"	\$59.40
P1016-86	2"	1"	\$48.30
P1898-82	3"	1"	\$42.30
P1016-88	4"	1"	\$61.80
P3280-92	3"	-	\$47.88



TRAVIS

Part No.	Size	Outlet	Price
BLCR200-075	2"	3/4"	\$28.61
BLCR300-075	3"	3/4"	\$22.45
BLCR400-075	4"	3/4"	\$42.75
BLCR200	2"	1"	\$38.81
BLCR300	3"	1"	\$33.20
BLCR400	4"	1"	\$55.09

PRESS-ON LATERAL FEMALE COUPLER



PIERCE

Part No.	Size	Outlet	Price
P1016-61	2"	3/4"	\$36.00
P1898-61	3"	3/4"	\$28.80
P1016-63	4"	3/4"	\$43.20
P1016-66	2"	1"	\$38.40
P1898-62	3"	1"	\$32.40
P1016-68	4"	1"	\$45.60
P3280-72	3"	-	\$30.00



TRAVIS

Part No.	Size	Outlet	Price
BLCR200K-075	2"	3/4"	Call
BLCR300K-075	3"	3/4"	Call
BLCR400K-075	4"	3/4"	Call
BLCR200K	2"	1"	\$28.61
BLCR300K	3"	1"	\$22.45
BLCR400K	4"	1"	\$42.75

PRESS-ON MAINLINE COUPLER SET



PIERCE

Part No.	Size	Price
P1014-92	3"	\$36.30
P1014-93	4"	\$49.80
P1014-95	6"	\$73.20



TRAVIS

Part No.	Size	Price
BLS200	2"	\$32.77
BLS300	3"	\$33.11
BLS400	4"	\$42.44
BLS500	5"	\$56.47
BLS600	6"	\$69.43
BLS700	7"	\$81.32
BLS800	8"	\$97.20

PRESS-ON FEMALE MAINLINE COUPLER



PIERCE

Part No.	Size	Price
P1014-72	3"	\$26.40
P1014-73	4"	\$33.60
P1014-75	6"	\$50.40

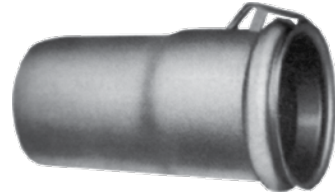

TRAVIS

Part No.	Size	Price
S200	2"	\$25.68
S300	3"	\$26.78
S400	4"	\$31.66
S500	5"	\$39.56
S600	6"	\$47.04
S700	7"	\$67.31
S800	8"	\$74.26

PRESS-ON MALE MAINLINE COUPLER



PIERCE

Part No.	Size	Price
P1042-01	3"	\$30.00
P1042-02	4"	\$36.00
P1042-03	5"	\$49.20
P1042-04	6"	\$60.00



TRAVIS

Part No.	Size	Price
BLSM300	3"	\$30.85
BLSM400	4"	\$35.62
BLSM500	5"	\$47.18
BLSM600	6"	\$58.12

UNIVERSAL PRESS-ON MAINLINE TEE TO LATERAL VALVE SET



PIERCE

Part No.	Size	Valve	Price
P1055-82	4"	3"	\$157.80
P1056-81	4"	4"	\$162.60
P1056-83	6"	4"	\$188.40



TRAVIS

Part No.	Size	Valve	Price
BLSUVT333	3"	3"	\$147.91
BLSUVT444	4"	4"	\$173.89
BLSUVT554	5"	4"	\$208.74
BLSUVT664	6"	4"	\$205.44
BLSUVT774	7"	4"	\$302.04
BLSUVT884	8"	4"	\$288.44

GALVANIZED STEEL BAND & LATCH FITTINGS

UNIVERSAL PRESS-ON MAINLINE TEE TO LATERAL VALVE



PIERCE

Part No.	Size	Valve	Price
P1055-62	4"	3"	\$141.60
P1056-61	4"	4"	\$146.40
P1056-63	6"	4"	\$165.60

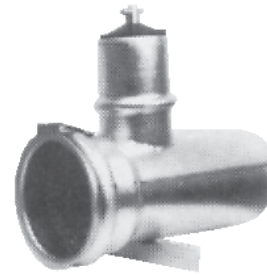

TRAVIS

Part No.	Size	Valve	Price
BLSUVT443-LBL	4"	3"	Call
BLSUVT444-LBL	4"	4"	\$173.89
BLSUVT664-LBL	6"	4"	\$205.44

UNIVERSAL IN-LINE MAINLINE TEE TO LATERAL VALVE



PIERCE

Part No.	Size	Valve	Price
P1072-62	4"	3"	\$144.00
P1073-61	4"	4"	\$165.60
P1073-63	6"	4"	\$211.20

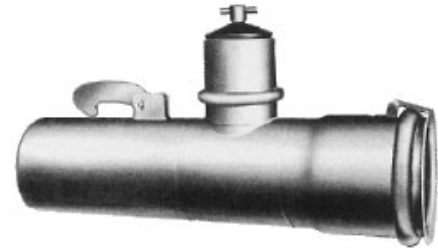

TRAVIS

Part No.	Size	Valve	Price
BLSUVT-L333	3"	3"	\$147.91
BLSUVT-L444	4"	4"	\$173.89
BLSUVT-L554	5"	4"	\$208.74
BLSUVT-L664	6"	4"	\$205.44
BLSUVT-L774	7"	4"	\$302.04
BLSUVT-L884	8"	4"	\$288.44

END TEE



PIERCE

Part No.	Size	Price
P1079-61	2"	\$117.60
P1077-61	3"	\$122.40
P1077-62	4"	\$148.80
P1078-62	6"	\$228.00

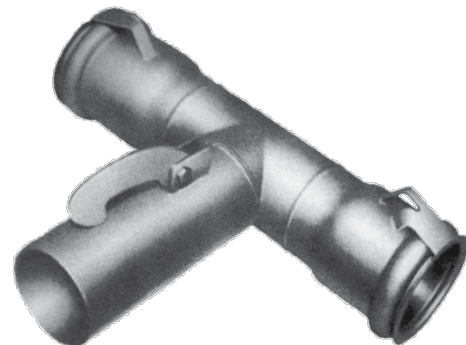

TRAVIS

Part No.	Size	Price
BLSET200	2"	\$106.34
BLSET300	3"	\$124.39
BLSET400	4"	\$147.58
BLSET500	5"	\$182.75
BLSET600	6"	\$221.36
BLSET700	7"	\$303.38
BLSET800	8"	\$342.47

GALVANIZED STEEL BAND & LATCH FITTINGS

FIELD / LINE TEE



PIERCE

Part No.	Size	Price
P1092-61	2"	\$120.00
P1091-61	3" x 3" x 2"	\$124.80
P1091-62	3"	\$127.20
P1090-62	4" x 4" x 3"	\$151.20
P1090-63	4"	\$159.60
P1089-64	6"	\$242.40



TRAVIS

Part No.	Size	Price
BLSFT200	2"	\$106.34
BLSFT300	3"	\$124.39
BLSFT400	4"	\$147.58
BLSFT500	5"	\$182.75
BLSFT600	6"	\$221.36
BLSFT700	7"	\$303.38
BLSFT800	8"	\$342.47

45° ELBOW



PIERCE

Part No.	Size	Price
P1121-61	2"	\$84.00
P1122-61	3"	\$96.00
P1123-61	4"	\$132.00
P1125-61	6"	\$198.00



TRAVIS

Part No.	Size	Price
BLSFE-200-45	2"	\$78.10
BLSFE-300-45	3"	\$90.54
BLSFE-400-45	4"	\$121.10
BLSFE-500-45	5"	\$148.75
BLSFE-600-45	6"	\$183.02
BLSFE-700-45	7"	\$231.79
BLSFE-800-45	8"	\$259.91

90° ELBOW



PIERCE

Part No.	Size	Price
P1103-61	2"	\$84.00
P1104-61	3"	\$94.80
P1105-61	4"	\$134.40
P1107-61	6"	\$216.00



TRAVIS

Part No.	Size	Price
BLSFE200	2"	\$95.41
BLSFE300	3"	\$96.90
BLSFE400	4"	\$131.66
BLSFE500	5"	\$170.21
BLSFE600	6"	\$198.78
BLSFE700	7"	\$252.24
BLSFE800	8"	\$278.08

REDUCER



PIERCE

Part No.	Size	Price
P1085-61	3" x 2"	\$60.00
P1085-63	4" x 3"	\$79.20
P1085-68	6" x 4"	\$112.80

TRAVIS

Part No.	Size	Price
BLSR203	3" x 2"	\$65.18
BLSR304	4" x 3"	\$82.34
BLSR405	5" x 4"	\$96.90
BLSR406	6" x 4"	\$121.85
BLSR506	6" x 5"	\$131.02
BLSR607	7" x 6"	\$159.80
BLSR608	8" x 6"	\$185.71
BLSR708	8" x 7"	\$189.38

WELD-ON STARTER COUPLER



PIERCE

Part No.	Size	Price
P1048-62	3"	\$25.20
P1048-63	4"	\$30.00
P1048-64	5"	\$39.60
P1048-65	6"	\$45.60
P1048-67	8"	\$61.20

TRAVIS

Part No.	Size	Price
SCGHB200	2"	\$28.18
SCGHB300	3"	\$28.97
SCGHB400	4"	\$32.66
SCGHB500	5"	\$37.88
SCGHB600	6"	\$41.26
SCGHB700	7"	\$48.05
SCGHB800	8"	\$48.49
SCGHB1000	10"	\$60.07
SCGHB1200	12"	\$75.40

END PLUG



PIERCE

Part No.	Size	Price
P1087-01	2"	\$34.80
P1087-02	3"	\$39.60
P1087-03	4"	\$54.00
P1087-04	5"	\$64.80
P1087-05	6"	\$74.40

TRAVIS

Part No.	Size	Price
BLSEP200	2"	\$30.89
BLSEP300	3"	\$24.85
BLSEP400	4"	\$40.50
BLSEP500	5"	\$58.63
BLSEP600	6"	\$74.16
BLSEP700	7"	\$100.14
BLSEP800	8"	\$107.72

DISCHARGE ADAPTER



PIERCE

Part No.	Size	Price
P1739-63	2" x 2"	\$33.60
P1740-63	2" x 3"	\$49.20
P1739-65	3" x 3"	\$50.40
P1740-67	3" x 4"	\$67.20
P1739-66	4" x 4"	\$67.30



TRAVIS

Part No.	Size	Price
BLSDA202	2" x 2"	\$77.80
BLSDA203	2" x 3"	\$77.80
BLSDA204	2" x 4"	\$71.44
BLSDA303	3" x 3"	\$83.11
BLSDA304	3" x 4"	\$113.83
BLSDA404	4" x 4"	\$100.90
BLSDA405	4" x 5"	\$110.89
BLSDA406	4" x 6"	\$143.04
BLSDA407	4" x 7"	\$153.34
BLSDA505	5" x 5"	\$134.35
BLSDA506	5" x 6"	\$144.10
BLSDA507	5" x 7"	\$159.95
BLSDA508	5" x 8"	\$165.67
BLSDA606	6" x 6"	\$178.22
BLSDA607	6" x 7"	\$198.18
BLSDA608	6" x 8"	\$216.19

FEMALE COUPLER X HOSE BARB



PIERCE

Part No.	Size	Price
P1788-61	2"	\$40.80
P1788-62	3"	\$42.00
P1788-63	4"	\$49.20
P1788-64	5"	\$66.00
P1788-65	6"	\$75.60



TRAVIS

Part No.	Size	Price
BLSHF200	2"	\$36.12
BLSHF300	3"	\$42.37
BLSHF400	4"	\$47.77
BLSHF500	5"	\$69.61
BLSHF600	6"	\$79.84
BLSHF800	8"	\$99.77

MALE END X HOSE BARB



PIERCE

Part No.	Size	Price
P1791-01	2"	\$48.00
P1791-02	3"	\$49.20
P1791-04	4"	\$52.80
P3150-04	4" with floating band	Call
P1791-06	5"	\$76.80
P1791-07	6"	\$86.40



TRAVIS

Part No.	Size	Price
BLSHM200	2"	\$41.28
BLSHM300	3"	\$37.58
BLSHM400	4"	\$47.53
BLSHM500	5"	\$82.66
BLSHM600	6"	\$101.70
BLSHM800	8"	\$127.08

WELD-ON FITTINGS - GALVANIZED STARTER COUPLERS

BAND & LATCH FEMALE STARTER COUPLER

PIERCE

Part No.	Size	Price
P1048-62	3"	\$25.20
P1048-63	4"	\$30.00
P1048-64	5"	\$39.60
P1048-65	6"	\$45.60
P1048-67	8"	\$61.20



TRAVIS

Part No.	Size	Price
SCGHB200	2"	\$28.18
SCGHB300	3"	\$28.97
SCGHB400	4"	\$32.66
SCGHB500	5"	\$37.88
SCGHB600	6"	\$41.26
SCGHB700	7"	\$49.78
SCGHB800	8"	\$48.49
SCGHB1000	10"	\$57.41
SCGHB1200	12"	Call



RING LOCK MALE STARTER COUPLER

PIERCE

Part No.	Size	Price
P1678-12	4"	\$24.00
P1676-11	5"	\$27.60
P1676-12	6"	\$27.78
P1676-14	8"	\$39.97
P1676-15	10"	\$57.13



TRAVIS - 14 GA

Part No.	Size	Price
SCGM300	3"	\$18.00
SCGM400	4"	\$20.41
SCGM500	5"	\$22.64
SCGM600	6"	\$20.78



TRAVIS - 12 GA

Part No.	Size	Price
SCGM800	8"	\$34.09
SCGM1000	10"	\$46.98
SCGM1200	12"	\$66.29

RING LOCK FEMALE STARTER COUPLER - STANDARD PUNCH

PIERCE

Part No.	Size	Price
P1669-12	4"	\$21.60
P1669-14	6"	\$28.80
P1669-16	8"	\$45.60
P1669-17	10"	\$60.00
P1669-18	12"	\$72.00



TRAVIS

Part No.	Size	Price
SCG200	2"	\$12.31
SCG300	3"	\$16.97
SCG400	4"	\$16.16
SCG500	5"	\$23.48
SCG600	6"	\$19.93
SCG800	8"	\$28.78
SCG1000	10"	\$39.11
SCG1200	12"	\$64.25



RING LOCK FEMALE STARTER COUPLER - DEEP PUNCH

PIERCE

Part No.	Size	Price
P1007-53	4"	\$26.40
P1007-54	5"	\$28.80
P1007-55	6"	\$34.80
P1007-57	8"	\$52.80
P1007-58	10"	\$67.20
P1007-59	12"	\$79.20



TRAVIS

Part No.	Size	Price
SCG400D	4"	\$22.99
SCG500D	5"	Call
SCG600D	6"	\$34.31
SCG800D	8"	\$44.33
SCG1000D	10"	\$55.34
SCG1200D	12"	Call



PRESS-ON MAINLINE COUPLER SET

PIERCE

Part No.	Size	Price
P1671-92	4"	\$66.00
P1671-93	5"	Call
P1671-94	6"	\$85.20
P1671-96	8"	\$117.60
P1671-97	10"	\$169.20
P1671-98	12"	\$214.80



TRAVIS

Part No.	Size	Price
SRL300	3"	\$61.49
SRL400	4"	\$63.92
SRL500	5"	\$79.96
SRL600	6"	\$83.56
SRL700	7"	\$113.70
SRL800	8"	\$108.44
SRL1000	10"	\$138.42
SRL1200	12"	\$191.58



PRESS-ON FEMALE MAINLINE COUPLER

PIERCE

Part No.	Size	Price
P1671-72	4"	\$26.40
P1671-73	5"	Call
P1671-74	6"	\$36.00
P1671-76	8"	\$55.20
P1671-77	10"	\$82.80
P1671-78	12"	\$106.80



TRAVIS

Part No.	Size	Price
SRL-F300	3"	\$22.61
SRL-F400	4"	\$19.44
SRL-F500	5"	\$30.98
SRL-F600	6"	\$27.84
SRL-F700	7"	\$44.94
SRL-F800	8"	\$40.19
SRL-F1000	10"	\$63.62
SRL-F1200	12"	\$89.53

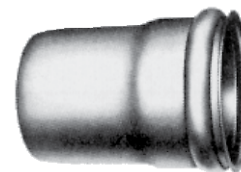

PRESS-ON MALE COUPLER

PIERCE

Part No.	Size	Price
P1677-12	4"	\$21.60
P1675-12	6"	\$27.60
P1675-14	8"	\$38.40
P1675-15	10"	\$57.60
P1675-16	12"	\$72.00



TRAVIS

Part No.	Size	Price
SRL-M300	3"	\$20.88
SRL-M400	4"	\$22.90
SRL-M500	5"	\$27.19
SRL-M600	6"	\$29.38
SRL-M700	7"	\$39.18
SRL-M800	8"	\$41.98
SRL-M1000	10"	\$54.06
SRL-M1200	12"	\$69.73

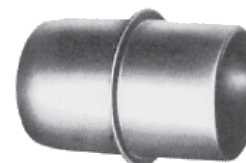

BLACK STEEL RING LOCK FITTINGS

WELD-ON MALE STARTER COUPLER

PIERCE

Part No.	Size	Price
P1678-02	4"	\$20.40
P1676-01	5"	\$25.20
P1676-02	6"	\$26.40
P1676-04	8"	\$33.60
P1676-05	10"	\$45.60
P1676-06	12"	\$57.60



TRAVIS

Part No.	Size	Price
SCBM300	3"	\$14.40
SCBM400	4"	\$16.79
SCBM500	5"	\$19.07
SCBM600	6"	\$17.93
SCBM800	8"	\$22.45
SCBM1000	10"	\$33.88
SCBM1200	12"	\$62.71



WELD-ON FEMALE STARTER COUPLER - STANDARD PUNCH

PIERCE

Part No.	Size	Price
P1669-42	4"	\$18.60
P1669-44	6"	\$24.00
P1669-46	8"	\$36.00
P1669-47	10"	\$48.00
P1669-48	12"	\$64.80



TRAVIS

Part No.	Size	Price
SCB200	2"	\$12.31
SCB300	3"	\$13.92
SCB400	4"	\$13.41
SCB500	5"	\$19.88
SCB600	6"	\$26.94
SCB800	8"	\$25.76
SCB1000	10"	\$57.36
SCB1200	12"	\$64.25



WELD-ON FEMALE STARTER COUPLER - DEEP PUNCH

PIERCE

Part No.	Size	Price
P1007-41	2"	\$15.60
P1007-42	3"	\$16.20
P1007-43	4"	\$19.20
P1007-44	5"	\$24.00
P1007-45	6"	\$30.00
P1007-47	8"	\$42.00
P1007-48	10"	\$54.00
P1007-49	12"	\$56.40



TRAVIS

Part No.	Size	Price
SCB400D	4"	\$24.96
SCB500D	5"	\$37.29
SCB600D	6"	\$31.39
SCB800D	8"	\$42.66
SCB1000D	10"	\$57.36
SCB1200D	12"	\$86.56



GALVANIZED STEEL RING LOCK FITTINGS

WELD-ON MALE STARTER COUPLER

PIERCE

Part No.	Size	Price
P1678-12	4"	Call
P1676-11	5"	Call
P1676-12	6"	Call
P1676-14	8"	Call
P1676-15	10"	Call



TRAVIS

Part No.	Size	Price
SCGM300	3"	\$18.00
SCGM400	4"	\$20.41
SCGM500	5"	\$22.64
SCGM600	6"	\$20.78
SCGM800	8"	\$34.09
SCGM1000	10"	\$46.98
SCGM1200	12"	\$66.29



HOSE BARBS

PIERCE

Part No.	Size	Price
P1790-02	3"	\$16.80
P1790-04	4"	\$18.00
P1790-05	4-1/2"	\$19.20
P1790-06	5"	\$25.20
P1790-07	6"	\$27.60
P1790-08	8"	\$42.00



TRAVIS

Part No.	Size	Price
HOSEBEAD-2	2"	\$14.75
HOSEBEAD-21/2	2-1/2"	\$15.29
HOSEBEAD-3	3"	\$15.53
HOSEBEAD-4	4"	\$16.75
HOSEBEAD-41/2	4-1/2"	\$21.91
HOSEBEAD-5	5"	\$20.52
HOSEBEAD-6	6"	\$22.45
HOSEBEAD-8	8"	\$42.85
HOSEBEAD-10	10"	\$61.24
HOSEBEAD-12	12"	\$75.05



FLAT DISCS

PIERCE

Part No.	Size	Price
P1067-02	2"	\$3.00
P1067-05	3"	\$3.60
P1067-09	4"	\$5.04
P1067-11	5"	\$6.24
P1067-14	6"	\$7.32
P1067-21	8"	\$12.36
P1067-25	10"	\$31.20
P1067-29	12"	\$48.00



TRAVIS STEEL

Part No.	Size	Price
WD-2	2"	\$2.18
WD-3	3"	\$3.08
WD-4	4"	\$3.92
WD-5	5"	\$5.51
WD-6	6"	\$5.77
WD-658	6-5/8"	Call
WD-7	7"	\$10.57
WD-8	8"	\$11.98
WD-10	10"	\$17.46
WD-12	12"	\$23.20



1/2" CARBON PLATE FLANGES

OD PIPE SIZE

Part No.	Size	Price
PFH0200-16	2"	\$7.57
PFH0250-16	2-1/2"	\$9.54
PFH0300-16	3"	\$10.08
PFH0400-16	4"	\$13.65
PFH0500-16	5"	\$21.20
PFH0600-16	6"	\$17.50
PFH0800-16	8"	\$25.26
PFH1000-16	10"	\$33.94
PFH1200-16	12"	\$49.20
PFH1400	14"	\$57.95
PFH1600	16"	\$88.00



IPS PIPE SIZE

Part No.	Size	Price
PFH0200	2"	\$7.57
PFH0250	2-1/2"	\$9.54
PFH0300	3"	\$9.80
PFH0400	4"	\$13.45
PFH0500	5"	\$13.77
PFH0600	6"	\$16.63
PFH0800	8"	\$23.03
PFH1000	10"	\$31.09
PFH1200	12"	\$49.20



WELD-ON FITTINGS - BLACK STARTER COUPLERS

BAND & LATCH FEMALE STARTER COUPLER - STANDARD PUNCH



TRAVIS

Part No.	Size	Price
SCBHB200	2"	\$24.31
SCBHB300	3"	\$25.92
SCBHB400	4"	\$29.04
SCBHB500	5"	\$34.28
SCBHB600	6"	\$37.61
SCBHB700	7"	\$44.46
SCBHB800	8"	Call
SCBHB1000	10"	Call
SCBHB1200	12"	Call



RING LOCK MALE STARTER COUPLER

PIERCE

Part No.	Size	Price
P1678-02	4"	\$20.40
P1676-01	5"	\$25.20
P1676-02	6"	\$26.40
P1676-04	8"	\$33.60
P1676-05	10"	\$45.60
P1676-06	12"	\$57.60



TRAVIS

Part No.	Size	Price
SCBM300	3"	\$14.40
SCBM400	4"	\$16.79
SCBM500	5"	\$19.07
SCBM600	6"	\$17.93
SCBM800	8"	\$22.45
SCBM1000	10"	\$33.88
SCBM1200	12"	\$62.71



RING LOCK FEMALE STARTER COUPLER - STANDARD PUNCH

PIERCE

Part No.	Size	Price
P1669-42	4"	\$18.60
P1669-44	6"	\$24.00
P1669-46	8"	\$36.00
P1669-47	10"	\$48.00
P1669-48	12"	\$64.80



TRAVIS

Part No.	Size	Price
SCB200	2"	\$12.31
SCB300	3"	\$13.92
SCB400	4"	\$13.41
SCB500	5"	\$19.88
SCB600	6"	\$26.94
SCB800	8"	\$25.76
SCB1000	10"	\$36.12
SCB1200	12"	\$64.25



RING LOCK FEMALE STARTER COUPLER - DEEP PUNCH

PIERCE

Part No.	Size	Price
P1007-41	2"	\$15.60
P1007-42	3"	\$16.20
P1007-43	4"	\$19.20
P1007-44	5"	\$24.00
P1007-45	6"	\$30.00
P1007-47	8"	\$42.00
P1007-48	10"	\$48.00
P1007-49	12"	\$56.40



TRAVIS

Part No.	Size	Price
SCB400D	4"	\$24.96
SCB500D	5"	\$37.29
SCB600D	6"	\$34.31
SCB800D	8"	\$42.66
SCB1000D	10"	\$57.36
SCB1200D	12"	Call



CONCENTRIC CONES

PIERCE - 12 GAUGE

Part No.	Size	Price
P1081-02	3" x 2"	\$7.20
P1081-03	4" x 2"	\$10.80
P1081-09	4" x 3"	\$8.40
P1081-10	5" x 3"	\$14.40
P1081-14	5" x 4"	\$9.60
P1081-15	6" x 4"	\$15.60
P1081-19	6" x 5"	\$14.40
P1081-23	6" x 7"	\$16.80
P1081-27	7" x 8"	\$18.00
P1081-24	8" x 6"	\$24.00
P1081-29	9" x 8"	\$25.20
P1081-30	10" x 8"	\$28.80
P1081-34	12" x 10"	\$34.80



TRAVIS - 14 GAUGE / 12 GAUGE

Part No.	Size	Gauge	Price
BWC-14-23	2" x 3"	14	\$5.58
BWC-14-24	2" x 4"	14	\$11.90
BWC-14-34	3" x 4"	14	\$5.39
BWC-14-35	3" x 5"	14	\$15.02
BWC-14-45	4" x 5"	14	\$9.20
BWC-14-36	3" x 6"	14	\$22.56
BWC-14-46	4" x 6"	14	\$13.01
BWC-10-46	4" x 6"	10	\$17.20
BWC-14-56	5" x 6"	14	\$9.72
BWC-10-56	5" x 6"	10	\$12.80
BWC-14-67	6" x 7"	14	\$16.42
BWC-14-48	4" x 8"	14	\$40.21
BWC-14-58	5" x 8"	14	\$31.75
BWC-14-68	6" x 8"	14	\$15.15
BWC-12-78	7" x 8"	12	\$18.10
BWC-12-89	8" x 9"	12	Call
BWC-12-810	8" x 10"	12	\$21.25
BWC-12-910	9" x 10"	12	Call
BWC-12-1210	10" x 12"	12	\$29.76

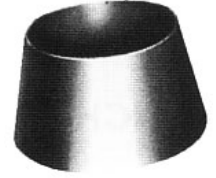

PIERCE - 10 GAUGE

Part No.	Size	Price
P0038-80	4" x 2"	\$16.80
P3684-01	4" x 3"	\$10.80
P3684-09	5" x 3"	\$19.20
P3684-02	5" x 4"	\$12.00
P3684-03	6" x 4"	\$19.20
P3684-04	6" x 5"	\$19.20
P3684-05	8" x 6"	\$27.60
P3684-06	10" x 8"	\$34.80
P3684-07	12" x 10"	\$45.60

TRAVIS - 10 GAUGE

Part No.	Size	Price
BWC-10-46	4" x 6"	\$20.72
BWC-10-56	5" x 6"	\$12.80
BWC-10-67	6" x 7"	\$21.65
BWC-10-48	4" x 8"	\$51.95
BWC-10-58	5" x 8"	\$42.58
BWC-10-68	6" x 8"	\$22.49
BWC-10-78	7" x 8"	\$22.16
BWC-10-89	8" x 9"	\$25.75
BWC-10-810	8" x 10"	\$42.00
BWC-10-910	9" x 10"	\$37.20
BWC-10-1012	10" x 12"	\$51.38

ECCENTRIC CONES

PIERCE - 12 GAUGE

Part No.	Size	Price
P1734-01	3" x 2"	\$40.80
P1734-03	4" x 3"	\$60.00
P1735-03	5" x 3"	\$62.40
P1734-06	5" x 4"	\$72.00
P1735-04	6" x 3"	\$74.40
P1735-06	6" x 4"	\$75.60
P1734-08	6" x 5"	\$72.00
P1736-03	8" x 4"	\$141.60
P1735-10	8" x 5"	\$110.40
P1735-12	8" x 6"	\$100.80
P1735-14	10" x 8"	\$134.40
P1735-16	12" x 10"	\$182.40



TRAVIS - 14 GAUGE / 12 GAUGE

Size	14 Gauge	Price	14 Gauge	Price
3" x 2"	BEC-14-32	\$42.19		
4" x 2"	BEC-14-42	\$53.84		
4" x 3"	BEC-14-43	\$48.80		
5" x 3"	BEC-14-53	\$62.81		
5" x 4"	BEC-14-54	\$59.70	BEC-10-54	\$82.61
6" x 3"	BEC-14-63	\$78.66	BEC-10-63	Call
6" x 4"	BEC-14-64	\$76.32	BEC-10-64	\$105.65
6" x 5"	BEC-14-65	\$70.75	BEC-10-65	\$97.92
8" x 4"	BEC-14-84	\$98.54	BEC-10-84	\$118.30
8" x 5"	BEC-14-85	\$95.18	BEC-10-85	\$114.28
8" x 6"	BEC-14-86	\$89.09	BEC-10-86	\$106.96
10" x 6"	BEC-14-106	\$136.85	BEC-10-106	\$164.30
10" x 8"	BEC-14-108	\$136.68	BEC-10-108	\$164.09
12" x 6"	BEC-14-126	\$187.78	BEC-10-126	\$187.78
12" x 8"	BEC-14-128	\$148.26	BEC-10-128	\$177.98
12" x 10"	BEC-14-1210	\$171.37	BEC-10-1210	\$171.37



TEE

PIERCE

Part No.	Size	Price
F090-036D06	6"	Call
F090-036D08	8"	Call
F090-036D10	10"	Call
F090-036D12	12"	Call



TRAVIS - 10 / 12 GAUGE

Part No.	Gauge	Size	Price
SWT300	10	3"	\$68.05
SWT400	10	4"	\$74.80
SWT500	10	5"	\$81.90
SWT600	10	6"	\$96.85
SWT800	12	8"	\$141.22
SWT1000	12	10"	\$172.56
SWT1200	12	12"	\$249.94



90° ELBOW

PIERCE SWEEP

Part No.	Size	Price
P1097-12	3"	\$36.00
P1097-13	4"	\$56.20
P1097-15	6"	\$76.80



TRAVIS SWEEP

Part No.	Size	Price
SWE300	3"	\$44.64
SWE400	4"	\$64.56



PIERCE MITERED

Part No.	Size	Price
P1110-05	8"	\$120.00
P1110-06	10"	\$134.40
P1110-07	12"	\$264.00



TRAVIS MITERED

Part No.	Size	Price
SWE500	5"	\$77.41
SWE600	6"	\$68.33
SWE800	8"	\$104.19
SWE1000	10"	\$133.39



45° ELBOW

PIERCE SWEEP

Part No.	Size	Price
P1100-12	3"	\$36.00
P1100-13	4"	\$56.40
P1100-15	6"	\$62.40



TRAVIS MITERED

Part No.	Size	Price
SWE-45300	3"	\$40.22
SWE-45400	4"	\$57.43
SWE-45500	5"	\$67.62
SWE-45600	6"	\$70.40
SWE-45700	7"	\$108.48
SWE-45800	8"	\$88.79
SWE-451000	10"	\$111.72

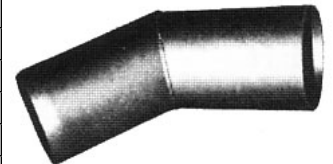

PIERCE MITERED

Part No.	Size	Price
P1111-05	8"	\$86.40
P1111-06	10"	\$134.40
P1111-07	12"	\$158.40



SCH. 40 BLACK BUTT WELD FITTINGS - STEEL

TEE - SCH. 40

Part No.	Size	Price
MAT-MNT11	3"	\$66.53
MAT-MNT12	4"	\$109.80
MAT-MNT13	5"	\$114.31
MAT-MNT14	6"	\$199.41
MAT-MNT15	8"	\$391.78
MAT-MNT16	10"	\$548.28



90° ELL - SCH. 40

Part No.	Size	Price
MAT-MN90LR10	3"	\$18.93
MAT-MN90LR11	4"	\$31.19
MAT-MN90LR12	5"	\$67.25
MAT-MN90LR13	6"	\$68.79
MAT-MN90LR14	8"	\$129.89
MAT-MN90LR15	10"	\$258.54



45° ELL - SCH. 40

Part No.	Size	Price
MAT-MN4510	3"	\$15.51
MAT-MN4511	4"	\$27.95
MAT-MN4513	6"	\$54.99
MAT-MN4514	8"	\$91.59
MAT-MN4515	10"	\$182.82

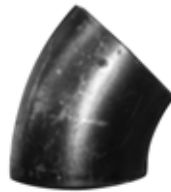

CAP - SCH. 40

Part No.	Size	Price
MAT-MNCA10	3"	\$13.09
MAT-MNCA11	4"	\$19.10
MAT-MNCA12	5"	\$29.41
MAT-MNCA13	6"	\$32.62
MAT-MNCA14	8"	\$49.36
MAT-MNCA15	10"	\$89.50



CONCENTRIC REDUCER - SCH. 40

Part No.	Size	Price
MAT-MNCR1008	3" x 2"	\$21.81
MAT-MNCR1108	4" x 2"	\$31.83
MAT-MNCR1110	4" x 3"	\$26.06
MAT-MNCR1210	5" x 3"	\$65.92
MAT-MNCR1211	5" x 4"	\$48.37
MAT-MNCR1310	6" x 3"	\$66.17
MAT-MNCR1311	6" x 4"	\$54.64
MAT-MNCR1312	6" x 5"	\$48.87
MAT-MNCR1411	8" x 4"	\$92.23
MAT-MNCR1412	8" x 5"	\$80.70
MAT-MNCR1413	8" x 6"	\$71.68
MAT-MNCR1513	10" x 6"	\$130.58
MAT-MNCR1514	10" x 8"	\$139.10
MAT-MNCR1615	12" x 10"	\$171.93



ECCENTRIC REDUCER - SCH. 40

Part No.	Size	Price
MAT-MNER1108	4" x 2"	\$34.08
MAT-MNER1110	4" x 3"	\$41.61
MAT-MNER1210	5" x 3"	\$83.96
MAT-MNER1211	5" x 4"	\$83.96
MAT-MNER1310	6" x 3"	\$134.34
MAT-MNER1311	6" x 4"	\$85.72
MAT-MNER1312	6" x 5"	\$61.65
MAT-MNER1411	8" x 4"	\$199.75
MAT-MNER1413	8" x 6"	\$109.28
MAT-MNER1414	8" x 8"	\$186.95
DG-ER-1006	10" x 6"	\$169.78
MAT-MNER1514	10" x 8"	\$143.11



GALVANIZED STEEL RING LOCK FITTINGS

MALE END RINGS

STEEL WELD RING

Part No.	Size	Price
SWR-6	6"	Call
SWR-8	8"	Call
SWR-10	10"	Call



TRAVIS - BOLT ON ADJUSTABLE MALE END

Part No.	Size	Price
SRLMBO600	6"	\$51.34
SRLMBO800	8"	\$57.49
SRLMBO1000	10"	\$66.40



45° ELBOW

PIERCE

Part No.	Size	Price
P1799-62	4"	\$115.20
P1798-61	6"	\$136.80
P1798-63	8"	\$213.60
P1798-64	10"	\$286.80
P1798-65	12"	\$357.60



TRAVIS

Part No.	Size	Price
SRLFE300-45	3"	\$96.49
SRLFE400-45	4"	\$106.26
SRLFE500-45	5"	\$122.56
SRLFE600-45	6"	\$142.84
SRLFE800-45	8"	\$181.48
SRLFE1000-45	10"	\$244.22
SRLFE1200-45	12"	\$296.02



90° ELBOW

PIERCE

Part No.	Size	Price
P1796-62	4"	\$117.60
P1797-61	6"	\$168.00
P1797-63	8"	\$230.40
P1797-64	10"	\$324.00
P1797-65	12"	\$448.80



TRAVIS

Part No.	Size	Price
SRLFE300	3"	\$111.53
SRLFE400	4"	\$123.31
SRLFE500	5"	\$148.31
SRLFE600	6"	\$169.70
SRLFE800	8"	\$231.71
SRLFE1000	10"	\$306.72
SRLFE1200	12"	\$366.70



UNIVERSAL MAINLINE TEE TO LATERAL VALVE SET

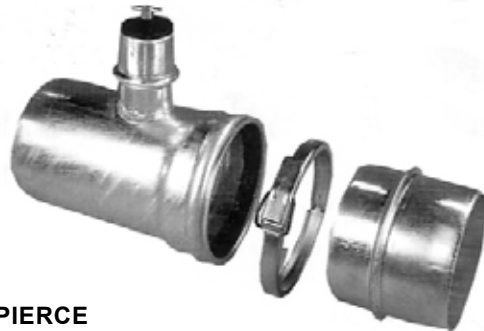

PIERCE

Part No.	Size	Price
P1761-81	4" x 4" x 4"	\$176.40
P1761-82	5" x 5" x 4"	Call
P1761-83	6" x 6" x 4"	\$222.00
P1761-84	8" x 8" x 4"	\$276.00
P1761-85	10" x 10" x 4"	\$324.00
P1761-86	12" x 12" x 4"	\$394.80



TRAVIS

Part No.	Size	Price
SRLUVT333	3" x 3" x 3"	\$168.67
SRLUVT444	4" x 4" x 4"	\$168.67
SRLUVT554	5" x 5" x 4"	\$191.03
SRLUVT664	6" x 6" x 4"	\$208.02
SRLUVT884	8" x 8" x 4"	\$249.10
SRLUVT10104	10" x 10" x 4"	\$271.68
SRLUVT12124	12" x 12" x 4"	\$323.59

UNIVERSAL IN-LINE MAINLINE TEE TO LATERAL VALVE

PIERCE

Part No.	Size	Price
P1761-61	4" x 4" x 4"	\$136.80
P1761-63	6" x 6" x 4"	\$172.80
P1761-64	8" x 8" x 4"	\$213.60
P1761-65	10" x 10" x 4"	\$237.60
P1761-66	12" x 12" x 4"	\$286.80



TRAVIS

Part No.	Size	Price
SRLUVT-L444	4" x 4" x 4"	\$171.53
SRLUVT-L554	5" x 5" x 4"	\$174.59
SRLUVT-L664	6" x 6" x 4"	\$198.01
SRLUVT-L884	8" x 8" x 4"	\$230.05
SRLUVT-L10104	10" x 10" x 4"	\$263.36
SRLUVT-L12124	12" x 12" x 4"	\$287.58



END TEE

PIERCE

Part No.	Size	Price
P1181-61	4"	\$132.00
P1181-63	6"	\$199.20
P1181-65	8"	\$292.80
P1181-66	10"	\$446.40
P1181-67	12"	\$585.60



TRAVIS

Part No.	Size	Price
SRLET300	3"	\$140.03
SRLET400	4"	\$144.80
SRLET500	5"	\$161.59
SRLET600	6"	\$176.05
SRLET800	8"	\$245.89
SRLET1000	10"	\$403.42
SRLET1200	12"	\$531.11



LINE / FIELD TEE

PIERCE

Part No.	Size	Price
P1504-62	4"	\$132.00
P1506-64	6"	\$196.80
P1507-65	8"	\$261.60
P1509-61	10"	\$446.40
P1680-67	12"	\$595.20



TRAVIS

Part No.	Size	Price
SRLFT300	3"	\$140.03
SRLFT400	4"	\$144.80
SRLFT500	5"	\$161.59
SRLFT600	6"	\$176.05
SRLFT800	8"	\$245.89
SRLFT1000	10"	\$403.42
SRLFT1200	12"	\$531.11



REDUCER - M X F

PIERCE

Part No.	Size	Price
P1838-62	6" x 4"	\$86.40
P1838-65	8" x 6"	\$127.20
P1838-66	10" x 8"	\$172.80
P1838-67	12" x 10"	\$216.00



TRAVIS

Part No.	Size	Price
SRLR304	4" x 3"	\$69.14
SRLR405	5" x 4"	\$78.52
SRLR406	6" x 4"	\$92.62
SRLR506	6" x 5"	\$98.70
SRLR608	8" x 6"	\$127.88
SRLR610	10" x 6"	\$182.17
SRLR810	10" x 8"	\$386.46
SRLR1012	12" x 10"	\$198.62



END PLUG

PIERCE

Part No.	Size	Price
P3206-01	4"	\$39.60
P3206-03	6"	\$55.20
P3206-05	8"	\$69.60
P3206-06	10"	\$108.00
P3206-07	12"	\$127.20



TRAVIS

Part No.	Size	Price
SRLEP300	3"	\$52.80
SRLEP400	4"	\$48.46
SRLEP500	5"	\$51.20
SRLEP600	6"	\$62.12
SRLEP800	8"	\$82.07
SRLEP1000	10"	\$121.10
SRLEP1200	12"	\$151.33



STEEL HOSE BARB FITTINGS

GALVANIZED FEMALE TWIST LOCK X HOSE BARB



TRAVIS

Part No.	Size	Price
STLHF404	4"	\$158.54
STLHF606	6"	\$250.40

GALVANIZED FEMALE TWIST LOCK X HOSE BARB REDUCER



TRAVIS

Part No.	Size	Price
STLHF604	6" x 4"	\$239.79
STLHF604.5	6" x 4-1/2"	\$248.82
STLHF605	6" x 5"	\$257.62

GALVANIZED MALE TWIST LOCK X HOSE BARB



TRAVIS

Part No.	Size	Price
STLHM606	6" x 6"	\$238.16

GALVANIZED MALE TWIST LOCK X HOSE BARB REDUCER



TRAVIS

Part No.	Size	Price
STLHM604	6" x 4"	\$227.32
STLHM604.5	6" x 4-1/2"	\$234.19
STLHM605	6" x 5"	\$244.99

GALVANIZED HOSE BARB SPLICER



TRAVIS

Part No.	Size	Price
HRC200	2"	\$33.96
HRC300	3"	\$37.82
HRC400	4"	\$41.39
HRC500	5"	\$61.00
HRC600	6"	\$65.46
HRC800	8"	\$100.01

BLACK WELD-ON HOSE BARB

PIERCE

Part No.	Size	Price
P1790-02	3"	\$16.80
P1790-04	4"	\$18.00
P1790-05	4-1/2"	\$19.20
P1790-06	5"	\$25.20
P1790-07	6"	\$27.60
P1790-08	8"	\$42.00



TRAVIS

Part No.	Size	Price
HOSEBEAD-2	2"	\$14.75
HOSEBEAD-21/2	2-1/2"	\$16.78
HOSEBEAD-3	3"	\$15.53
HOSEBEAD-4	4"	\$16.75
HOSEBEAD-5	5"	\$20.52
HOSEBEAD-6	6"	\$22.45
HOSEBEAD-8	8"	\$42.85
HOSEBEAD-10	10"	\$61.24

BOLTED COUPLINGS

WEDGE-TITE® COUPLER - 6" BODY LENGTH

IPS			Nominal	
Part No.	Price	Size	Part No.	Price
P9025-01	\$103.20	4"	P9025-04	\$103.20
P9026-01	\$114.00	5"	P9026-05	\$114.00
P9027-01	\$122.40	6"	P9027-05	\$122.40
P9028-01	\$144.00	8"	P9028-05	\$144.00
P9029-01	\$180.00	10"	P9029-05	\$180.00
P9030-01	\$240.00	12"	P9030-05	\$240.00



THREADED DISCHARGE ADAPTERS

RING LOCK DISCHARGE ADAPTER - GALVANIZED MIPT X FEMALE

Part No.	Size	Weight Lbs.	Price
SRLDA306	3" x 6"	8	\$124.00
SRLDA404	4" x 4"	7	\$87.36
SRLDA405	4" x 5"	8	\$95.26
SRLDA406	4" x 6"	10	\$122.51
SRLDA505	5" x 5"	9	\$121.79
SRLDA506	5" x 6"	10	\$130.09
SRLDA508	5" x 8"	14	\$163.71
SRLDA606	6" x 6"	15	\$165.47
SRLDA608	6" x 8"	16	\$205.92
SRLDA610	6" x 10"	20	\$236.76
SRLDA808	8" x 8"	17	\$219.83
SRLDA810	8" x 10"	22	\$251.74

FIPT also available



BAND & LATCH DISCHARGE ADAPTER - GALVANIZED MIPT X FEMALE

Part No.	Size	Weight Lbs.	Price
BLSDA202	2" x 2"	2	\$77.80
BLSDA203	2" x 3"	3	\$77.80
BLSDA303	3" x 3"	4	\$83.11
BLSDA304	3" x 4"	5	\$113.83
BLSDA404	4" x 4"	6	\$100.90
BLSDA405	4" x 5"	7	\$119.24
BLSDA406	4" x 6"	9	\$143.04
BLSDA407	4" x 7"	11	\$153.34
BLSDA505	5" x 5"	7	\$134.35
BLSDA506	5" x 6"	9	\$144.10
BLSDA507	5" x 7"	12	\$159.95
BLSDA508	5" x 8"	14	\$165.67
BLSDA606	6" x 6"	15	\$178.22
BLSDA607	6" x 7"	16	\$198.18
BLSDA608	6" x 8"	17	\$216.19



BAND & LATCH DISCHARGE ADAPTER - ALUMINUM MIPT X FEMALE

Part No.	Size	Price	Part No.	Size	Price
DA1502	1-1/2" x 2"	\$80.22	DA3005	3" x 5"	\$152.81
DA2002	2" x 2"	\$80.22	DA4005	4" x 5"	\$158.16
DA1503	1-1/2" x 3"	\$125.82	DA3006	3" x 6"	\$183.42
DA2003	2" x 3"	\$125.83	DA4006	4" x 6"	\$179.58
DA3003	3" x 3"	\$125.83	DA5006	5" x 6"	\$179.58
DA1504	1-1/2" x 4"	\$122.27	DA6006	6" x 6"	\$171.91
DA2004	2" x 4"	\$142.70	DA6007	6" x 7"	\$187.19
DA3004	3" x 4"	\$142.90	DA6008	6" x 8"	\$236.86
DA4004	4" x 4"	\$104.76	DA8008	8" x 8"	\$229.21



FLANGED DISCHARGE ADAPTERS



FLANGE X FEMALE RING LOCK DISCHARGE ADAPTERS

Part No.	Description	Price
RLSDA-FLG-404	4" Flange x 4" Female Ring Lock	\$84.78
RLSDA-FLG-406	4" Flange x 6" Female Ring Lock	\$120.05
RLSDA-FLG-408	4" Flange x 8" Female Ring Lock	\$165.95
RLSDA-FLG-604	6" Flange x 4" Female Ring Lock	\$123.88
RLSDA-FLG-606	6" Flange x 6" Female Ring Lock	\$151.79
RLSDA-FLG-608	6" Flange x 8" Female Ring Lock	\$203.32
RLSDA-FLG-804	8" Flange x 4" Female Ring Lock	\$165.95
RLSDA-FLG-806	8" Flange x 6" Female Ring Lock	\$208.16
RLSDA-FLG-808	8" Flange x 8" Female Ring Lock	\$210.49



FLANGE X MALE RING LOCK DISCHARGE ADAPTERS

Part No.	Description	Price
RLSDA-FLG-M-404	4" Flange x 4" Male Ring Lock	\$84.78
RLSDA-FLG-M-406	4" Flange x 6" Male Ring Lock	\$120.05
RLSDA-FLG-M-408	4" Flange x 8" Male Ring Lock	\$165.95
RLSDA-FLG-M-604	6" Flange x 4" Male Ring Lock	\$123.81
RLSDA-FLG-M-606	6" Flange x 6" Male Ring Lock	\$151.79
RLSDA-FLG-M-608	6" Flange x 8" Male Ring Lock	\$203.32
RLSDA-FLG-M-804	8" Flange x 4" Male Ring Lock	\$165.95
RLSDA-FLG-M-806	8" Flange x 6" Male Ring Lock	\$208.16
RLSDA-FLG-M-808	8" Flange x 8" Male Ring Lock	\$210.49



FLANGE X FEMALE BAND & LATCH DISCHARGE ADAPTERS

Part No.	Description	Price
BLSDA-FL-404	4" Flange x 4" Female Band & Latch	\$178.22
BLSDA-FL-406	4" Flange x 6" Female Band & Latch	\$144.47
BLSDA-FL-408	4" Flange x 8" Female Band & Latch	\$158.59
BLSDA-FL-604	6" Flange x 4" Female Band & Latch	\$144.47
BLSDA-FL-606	6" Flange x 6" Female Band & Latch	\$178.22
BLSDA-FL-608	6" Flange x 8" Female Band & Latch	\$197.04
BLSDA-FL-804	8" Flange x 4" Female Band & Latch	\$231.55
BLSDA-FL-806	8" Flange x 6" Female Band & Latch	\$233.34
BLSDA-FL-808	8" Flange x 8" Female Band & Latch	\$238.56



FLANGE X FEMALE TWIST LOCK DISCHARGE ADAPTERS

Part No.	Description	Price
TLSDA-FLG-404	4" Flange x 4" Female Twist Lock	\$172.16
TLSDA-FLG-406	4" Flange x 6" Female Twist Lock	\$209.76
TLSDA-FLG-606	6" Flange x 6" Female Twist Lock	\$279.20



FLANGE X MALE TWIST LOCK DISCHARGE ADAPTERS

Part No.	Description	Price
TLSDA-M-FLG-604	6" Flange x 4" Male Twist Lock	Call
TLSDA-M-FLG-606	6" Flange x 6" Male Twist Lock	Call



FLANGE X MIPT DISCHARGE ADAPTERS

Part No.	Description	Price
SDA-FLG-402	4" Flange x 2" MIPT	\$88.08
SDA-FLG-403	4" Flange x 3" MIPT	\$100.69
SDA-FLG-603	6" Flange x 3" MIPT	\$148.31
SDA-FLG-404	4" Flange x 4" MIPT	\$90.53
SDA-FLG-604	6" Flange x 4" MIPT	\$151.55
SDA-FLG-804	8" Flange x 4" MIPT	\$248.16
SDA-FLG-605	6" Flange x 5" MIPT	\$164.72
SDA-FLG-606	6" Flange x 6" MIPT	\$138.04
SDA-FLG-806	8" Flange x 6" MIPT	\$269.33



FLANGE X FIPT DISCHARGE ADAPTERS

Part No.	Description	Price
SDA-FLG-F-404	4" Flange x 4" FIPT	\$102.76
SDA-FLG-F-604	6" Flange x 4" FIPT	\$153.17
SDA-FLG-F-606	6" Flange x 6" FIPT	\$182.09

FLANGED GALVANIZED FITTINGS

FLANGED 45° ELBOW

Part No.	Description	Price
SGFE-400-45	4" 45° Flanged Elbow	\$173.41
SGFE-500-45	5" 45° Flanged Elbow	\$201.22
SGFE-600-45	6" 45° Flanged Elbow	\$225.25
SGFE-800-45	8" 45° Flanged Elbow	\$295.55
SGFE-1000-45	10" 45° Flanged Elbow	\$398.56



FLANGED 90° ELBOW

Part No.	Description	Price
SGFE-400	4" 90° Flanged Elbow	\$182.21
SGFE-500	5" 90° Flanged Elbow	\$212.82
SGFE-600	6" 90° Flanged Elbow	\$254.44
SGFE-800	8" 90° Flanged Elbow	\$352.90
SGFE-1000	10" 90° Flanged Elbow	\$456.14



FLANGED CROSS

Part No.	Description	Price
SGC-4444	4" x 4" x 4" x 4" Flanged Cross	\$320.52
SGC-6666	6" x 6" x 6" x 6" Flanged Cross	\$359.41
SGC-8888	8" x 8" x 8" x 8" Flanged Cross	\$526.59
SGC-10101010	10" x 10" x 10" x 10" Flanged Cross	\$773.11



FLANGED TEE

Part No.	Description	Price
SGFT-444	4" x 4" x 4" Flanged Tee	\$238.40
SGFT-666	6" x 6" x 6" Flanged Tee	\$294.24
SGFT-888	8" x 8" x 8" Flanged Tee	\$383.13
SGFT-101010	10" x 10" x 10" Flanged Tee	\$562.47



FLANGED CONCENTRIC REDUCER

Part No.	Description	Price
SGFFR-603	6" Flange x 3" Flange Reducer	\$119.14
SGFFR-604	6" Flange x 4" Flange Reducer	\$144.76
SGFFR-806	8" Flange x 6" Flange Reducer	\$196.28
SGFFR-1006	10" Flange x 6" Flange Reducer	\$270.88



PIERCE GALVANIZED STEEL VALVE OPENING ELBOWS & TEES

RING LOCK VALVE OPENING ELBOW

Part No.	Ring Lock Inlet	Ring Lock Universal Bell Outlet	Price
P1716-62	3"	3"	Call
P1716-65	4"	4"	\$172.80
P1716-72	6"	4"	\$213.60
P1716-74	6"	6"	\$242.40
P1715-63	8"	6"	\$408.00
P1715-65	8"	8"	\$434.40
P3619-61	10"	10"	\$580.80



BAND & LATCH VALVE OPENING ELBOW

Part No.	Ring Lock Inlet	Band & Latch Universal Bell Outlet	Side Outlet	Price
P1694-61	3"	2"	-	\$148.80
P1694-62	3"	3"	-	\$158.40
P1694-64	4"	3"	-	\$166.80
P1694-65	4"	4"	-	\$184.80
P1694-68	5"	4"	-	\$208.80
P1694-69	5"	5"	-	\$228.00
P1694-72	6"	4"	-	\$216.00
P1694-73	6"	5"	-	\$240.00
P1694-74	6"	6"	-	\$247.20
P1699-63	8"	6"	-	\$429.60
P1699-65	8"	8"	-	\$453.60
P0037-47	10"	8"	-	\$597.60
P0052-57	10"	10"	-	\$612.00
P1698-64	4"	3"	3/4"	\$181.20
P1698-65	4"	4"	3/4"	\$196.80



BAND & LATCH VALVE OPENING TEE

Part No.	Ring Lock Inlet	Band & Latch Universal Bell Outlet	Band & Latch Universal Bell Outlet	Side Outlet	Price
P1711-64	4"	3"	3"	-	\$206.40
P1711-65	4"	4"	4"	-	\$230.40
P1711-72	6"	4"	4"	-	\$271.20
P1711-74	6"	6"	6"	-	\$326.40
P1713-63	8"	6"	6"	-	\$453.60
P1712-76	8"	8"	8"	-	\$525.60
P3113-64	4"	3"	3"	3/4"	\$237.60
P3113-65	4"	4"	4"	3/4"	\$252.00



TRAVIS GALVANIZED STEEL VALVE OPENING ELBOWS & TEES

COMBINATION RING LOCK & BAND & LATCH VALVE OPENING ELBOW

Part No.	Ring Lock Inlet	RL / B&L Univ. Bell Outlet	Price
SUVEO302	3"	2"	\$163.36
SUVEO303	3"	3"	\$163.78
SUVEO402	4"	2"	Call
SUVEO403	4"	3"	\$178.38
SUVEO404	4"	4"	\$185.95
SUVEO504	5"	4"	\$234.26
SUVEO505	5"	5"	Call
SUVEO604	6"	4"	\$234.73
SUVEO605	6"	5"	\$251.12
SUVEO606	6"	6"	\$272.98
SUVEO806	8"	6"	\$360.92
SUVEO808	8"	8"	\$351.10



COMBINATION RING LOCK & BAND & LATCH VALVE OPENING TEE

Part No.	Ring Lock Inlet	RL / B&L Univ. Bell Outlet	Price
SUVEO-T322	3"	2" x 2"	\$206.40
SUVEO-T333	3"	3" x 3"	\$207.79
SUVEO-T433	4"	3" x 3"	\$220.78
SUVEO-T444	4"	4" x 4"	\$213.22
SUVEO-T544	5"	4" x 4"	\$271.92
SUVEO-T555	5"	5" x 5"	\$313.44
SUVEO-T644	6"	4" x 4"	\$289.82
SUVEO-T655	6"	5" x 5"	\$329.65
SUVEO-T666	6"	6" x 6"	\$346.84
SUVEO-T866	8"	6" x 6"	\$484.25
SUVEO-T888	8"	8" x 8"	\$489.12



GUN STAND OPENER

Part No.	Ring Lock Inlet	FIPT Outlet	Price
SUVEO-GS303	3"	3"	\$254.58
SUVEO-GS403	4"	3"	\$290.54



TRAVIS - RAINWAY ALUMINUM VALVE OPENING ELBOWS & TEES

RAINWAY UNIVERSAL VALVE ELBOW OPENER

Part No.	Ring Lock Inlet	Band & Latch Outlet	Price
UVEO302	3"	2"	\$156.47
UVEO303	3"	3"	\$157.57
UVEO403	4"	3"	\$166.21
UVEO404	4"	4"	\$173.33



RAINWAY UNIVERSAL VALVE TEE OPENER

Part No.	Ring Lock Inlet	Band & Latch Outlet	Price
UVEO-T433	4"	3" x 3"	\$220.84
UVEO-T444	4"	4" x 4"	\$248.68



RAINWAY SPECIALTY VALVE OPENERS

Part No.	Hook Type Inlet	Band & Latch Outlet	Price
RVEO302	3"	2"	\$237.36
RVEO303	3"	3"	\$237.36
RVEO403	4"	3"	\$242.96
RVEO404	4"	4"	\$242.96
RVEO505	5"	5"	\$312.91
RVEO606	6"	6"	\$396.29



To be used with V, RVTC, SRVML, RVML.

TRAVIS - RAINWAY ALUMINUM GUN STAND VALVE OPENER



RAINWAY UNIVERSAL GUN STAND VALVE OPENER

Part No.	Ring Lock Inlet	FIPT Outlet	Price
UVEO-GS303	3"	3"	\$300.72
UVEO-GS403	4"	3"	\$304.12

TRAVIS - A&M ALUMINUM VALVE OPENING ELBOWS & TEES

A&M VALVE OPENING ELBOW FOR 4" UNIVERSAL RISER VALVE

Part No.	Ring Lock Inlet	Band & Latch Outlet	Price
*V04333	4"	3"	\$166.21
V04433	4"	4"	\$173.29

* Come standard with 3/4" FIPT side outlet.

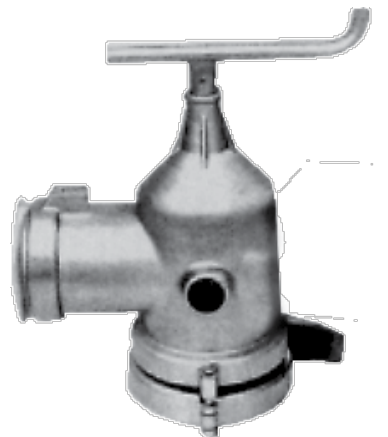

A&M VALVE OPENING TEE FOR 4" UNIVERSAL RISER VALVE

Part No.	Ring Lock Inlet	Band & Latch Outlet	Price
*V034333	4"	3" x 3"	\$257.42
V044433	4"	4" x 4"	\$283.51

* Come standard with 3/4" FIPT side outlet.



Intro 1 - Pivot 2 - Valves 3 - Surface 4 - IPS Epoxy / Galv. 5 - Suction Fittings 6 - PVC Fittings 7 - Sprinklers 8 - Malleable 9 - Hose 10 - Injectors / Filters 11 - Low Volume Formulas / TC

PIERCE GALVANIZED VALVE OPENER PARTS

GALVANIZED VALVE OPENER REPAIR PARTS

#	Part No.	Description	Price
1	P1681-01	Handle with Collar, 3" to 6"	\$20.40
1	P1174-01	Handle with Collar, 8"	\$25.20
2	P2107-06	Pin, Roll (Handle) 3" to 6"	\$1.80
2	P2107-11	Pin, Roll (Handle) 8"	\$1.80
3*	P1191-01	Stem with Solid Yoke, 3/4" 3" & 4"	\$18.00
3*	P1191-02	Stem with Solid Yoke, 3/4" 5" & 6"	\$20.40
3*	P1683-01	Stem with Solid Yoke, 1" for 8"	\$60.00
4	P2100-01	Gasket, Chevron, Rubber 3" to 6"	\$3.00
4	P2101-01	Gasket, Chevron, Rubber 8"	\$2.88
6	P2031-02	1/4" Lock Nut	\$0.72
7	P1679-01	Clamp Lock Ring 3"	\$28.80
7	P1679-02	Clamp Lock Ring 4"	\$30.00
7	P1679-03	Clamp Lock Ring 5"	\$36.00
7	P1679-04	Clamp Lock Ring 6"	\$33.60
7	P1679-05	Clamp Lock Ring 8"	\$42.00
8	P2018-10	Clamp Lock Bolt 1/4" x 3-1/2"	\$1.44
9	P2308-01	Clamp Lock Ring Bail 3" to 8"	\$3.12
10	YFV090-02503C	3" - 6" VOE Stem Yoke (Clutch)	\$15.60
8-10	F090-02508C	VOE Stem Yoke (Clutch)	\$26.40
**	P3040-01	Stem 3/4" x 7-1/4"	\$16.36
**	P3040-04	Stem 3/4" x 9-1/4"	\$17.26
**	P1683-01	Stem 1" x 16" VOE 8" & 10"	\$60.00

* New Style

** Old Style with holes.

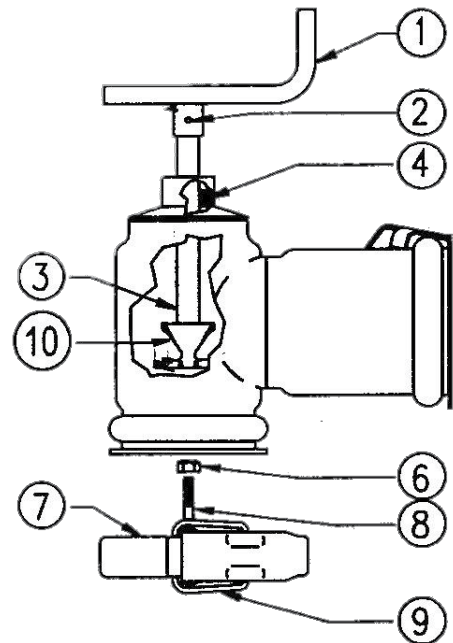

TRAVIS GALVANIZED VALVE OPENER PARTS

GALVANIZED VALVE OPENER REPAIR PARTS

Part No.	Description	Price
SUVEO-STEM-9.25	3/4" x 9-1/4" VOE Stem for 3" & 4" VOE	\$21.53
SUVEO-STEM-12	3/4" x 12" VOE Stem for 5" & 6" VOE	\$26.81
SUVEO-SSA-9	1 Pc. 3/4" Shaft 9" Long Socket Assy. for 3" & 4" VOE	\$29.89
SUVEO-SSA-15	1 Pc. 3/4" Shaft 15" Long Socket Assy. for 8" VOE	\$44.40
SUVEO-T-CRANK	3/4" Steel Crank Handle for 3" Thru 8" VOE	\$22.18
SUVEO-YOKE	Stem Shank Yoke, Only for 3" Thru 6" VOE (Fits 3/4" & 5/8" Stems)	\$9.34
SUVEO-CLAMP-3	3" Clamp Lock Ring for 3" VOE	\$24.40
SUVEO-CLAMP-4	4" Clamp Lock Ring for 4" VOE	\$26.57
SUVEO-CLAMP-5	5" Clamp Lock Ring for 5" VOE	\$27.14
SUVEO-CLAMP-6	6" Clamp Lock Ring for 6" VOE	\$29.38
SUVEO-CLAMP-8	8" Clamp Lock Ring for 8" VOE	\$31.72
SUVEO-HANDLEPIN	Handle Roll Pin 1"	\$0.55
SUVEO-SOCKETPIN	Socket (Yoke) Roll Pin 1-1/4"	\$0.73
CHEVRON-3/4	3/4" Chevron Gasket for VOE	\$1.94

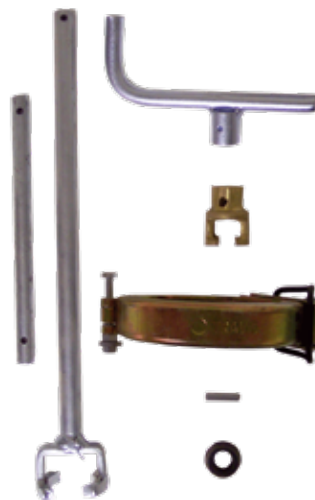

RAINWAY - ALUMINUM VALVE OPENER REPAIR PARTS

Part No.	Description	Price
UVEO-STEM-9-1/4	5/8" x 9-1/4" VOE Stem for 3" & 4" VOE	\$21.53
UVEO-T-CRANK-A	5/8" Aluminum Crank Handle for 3" & 4" VOE	\$17.41
UVEO-T-CRANK	5/8" Steel Crank Handle for 3" & 4" VOE	\$20.93
UVEO-YOKE	VOE Stem Shank Yoke (Yoke only)	\$9.34
UVEO-GLANDNUT	Gland Nut for VOE	\$9.40
UVEO-PACKING	Packing for VOE	\$6.84
UVEO-CLAMP-3	3" Clamp Lock Ring VOE	\$24.40
UVEO-CLAMP-4	4" Clamp Lock Ring VOE	\$26.57
UVEO-ROLLPIN	Handle Roll Pin	\$0.73
UVEO-SOCKETPIN	Socket (Yoke) Roll Pin 1-1/4"	\$0.84



GALVANIZED STEEL VALVE STUBS

PIERCE GALVANIZED VALVE STUBS

UNIVERSAL VALVE STUB - WELD-ON PLATED STEEL STEM

Part No.	Size	Length	Price
P1724-01	3"	4"	\$52.80
P1724-02	4"	6"	\$64.80
P1724-03	5"	6"	\$82.80
P1724-04	6"	6"	\$105.60
P1724-05	8"	9"	\$128.40
P1724-17	10"	10"	\$300.00



TRAVIS GALVANIZED VALVE STUBS

UNIVERSAL VALVE STUB - WELD-ON PLATED STEEL STEM

Part No.	Size	Length	Price
UVS-S300	3"	4"	\$49.64
UVS-S400	4"	6"	\$54.20
UVS-S500	5"	6"	\$78.47
UVS-S600	6"	6"	\$90.82
UVS-S800	8"	9"	\$251.42



UNIVERSAL VALVE STUB - WELD-ON STAINLESS STEEL STEM

Part No.	Size	Length	Price
P1724-01-SS	3"	4"	Call
P1724-02-SS	4"	6"	Call
P1724-03-SS	5"	6"	Call
P1724-04-SS	6"	6"	Call
P1724-05-SS	8"	9"	Call
P1724-17-SS	10"	10"	Call



UNIVERSAL VALVE STUB - WELD-ON STAINLESS STEEL STEM

Part No.	Size	Length	Price
UVS-S300-SS	3"	4"	\$57.35
UVS-S400-SS	4"	6"	\$61.50
UVS-S500-SS	5"	6"	Call
UVS-S600-SS	6"	6"	\$97.21
UVS-S800-SS	8"	9"	\$273.20



UNIVERSAL VALVE STUB - LONG BODY PLATED STEEL STEM

Part No.	Size	Length	Price
P1724-16	4"	9"	Call
P1724-08	4"	12"	Call
P1724-14	6"	9"	\$128.00
P1724-12	6"	12"	Call
P1724-05	8"	9"	\$259.20
P0013-65	8"	12"	Call
P1724-17	10"	10"	\$300.00



UNIVERSAL VALVE STUB - LONG BODY PLATED STEEL STEM

Part No.	Size	Length	Price
UVS-S400-09	4"	9"	Call
UVS-S400-12	4"	12"	Call
UVS-S500-09	5"	9"	Call
UVS-S500-12	5"	12"	Call
UVS-S600-09	6"	9"	\$101.70
UVS-S600-12	6"	12"	Call
UVS-S800-12	8"	12"	Call



UNIVERSAL VALVE STUB - LONG BODY STAINLESS STEEL STEM

Part No.	Size	Length	Price
P1724-16-SS	4"	9"	Call
P1724-08-SS	4"	12"	Call
P1724-14-SS	6"	9"	Call
P1724-12-SS	6"	12"	Call
P1724-05-SS	8"	9"	Call
P0013-65-SS	8"	12"	Call
P1724-17-SS	10"	10"	Call



UNIVERSAL VALVE STUB - LONG BODY STAINLESS STEEL STEM

Part No.	Size	Length	Price
UVS-S400-09-SS	4"	9"	Call
UVS-S400-12-SS	4"	12"	Call
UVS-S500-09-SS	5"	9"	Call
UVS-S500-12-SS	5"	12"	Call
UVS-S600-09-SS	6"	9"	Call
UVS-S600-12-SS	6"	12"	Call
UVS-S800-SS	8"	9"	Call
UVS-S800-12-SS	8"	12"	Call



UNIVERSAL VALVE STUB - 12" BODY W/ AIR VENT ARM PLATED STEEL STEM

Part No.	Size	Arm	Price
P0057-88	4"	2" MIPT	Call
P0052-46	6"	2" MIPT	Call
P0057-87	8"	2" MIPT	Call



UNIVERSAL VALVE STUB - 12" BODY W/ AIR VENT ARM PLATED STEEL STEM

Part No.	Size	Arm	Price
UVS-S412-AVA2	4"	2" MIPT	Call
UVS-S612-AVA2	6"	2" MIPT	Call
UVS-S812-AVA2	8"	2" MIPT	Call
UVS-S812-AVA3	8"	3" MIPT	Call



GALVANIZED STEEL VALVE STUBS

PIERCE GALVANIZED VALVE STUBS

UNIVERSAL VALVE STUB - FIPT INLET PLATED STEEL STEM

Part No.	Size	Price
P1726-01	3" x 3"	\$96.00
P1725-03	3" x 4"	\$98.40
P1726-02	4" x 4"	\$127.20
P1726-04	6" x 6"	\$216.00
P1726-05	8" x 8"	\$390.00
P0056-48	10" x 10"	\$534.00

Note: First number indicates thread size.



UNIVERSAL VALVE STUB - FIPT INLET STAINLESS STEEL STEM

Part No.	Size	Price
P1726-01-SS	3" x 3"	Call
P1725-03-SS	3" x 4"	Call
P1726-02-SS	4" x 4"	Call
P1726-04-SS	6" x 6"	Call
P1726-05-SS	8" x 8"	Call
P0056-48-SS	10" x 10"	Call

Note: First number indicates thread size.



UNIVERSAL VALVE STUB - MIPT INLET PLATED STEEL STEM

Part No.	Size	Price
P1729-01	3" x 3"	\$81.60
P1729-02	4" x 4"	\$103.20
P1729-04	6" x 6"	\$172.80
P1729-05	8" x 8"	\$350.40



UNIVERSAL VALVE STUB - MIPT INLET STAINLESS STEEL STEM

Part No.	Size	Price
P1729-01-SS	3" x 3"	Call
P1729-02-SS	4" x 4"	Call
P1729-04-SS	6" x 6"	Call
P1729-05-SS	8" x 8"	Call



TRAVIS - RAINWAY GALVANIZED VALVE STUBS

LUG TYPE VALVE STUB - WELD-ON

Part No.	Size	Length	Price
UVS-SL300	3"	6"	\$54.37
UVS-SL400	4"	6"	\$63.40
UVS-SL500	5"	6"	\$83.72
UVS-SL600	6"	6"	\$102.04



TRAVIS GALVANIZED VALVE STUBS

UNIVERSAL VALVE STUB - FIPT INLET PLATED STEEL STEM

Part No.	Size	Price
UVS-STF3002	3" x 2"	\$87.92
UVS-STF3003	3" x 3"	\$103.94
UVS-STF3004	3" x 4"	Call
UVS-STF4003	4" x 3"	\$101.39
UVS-STF4004	4" x 4"	\$128.16
UVS-STF5005	5" x 5"	\$219.46
UVS-STF6006	6" x 6"	\$250.36
UVS-STF8008	8" x 8"	\$481.94

Note: Second number indicates thread size.



UNIVERSAL VALVE STUB - FIPT INLET STAINLESS STEEL STEM

Part No.	Size	Price
UVS-STF3002-SS	3" x 2"	Call
UVS-STF3003-SS	3" x 3"	Call
UVS-STF4003-SS	4" x 3"	\$100.26
UVS-STF4004-SS	4" x 4"	\$128.92
UVS-STF5005-SS	5" x 5"	Call
UVS-STF6006-SS	6" x 6"	\$237.16
UVS-STF8008-SS	8" x 8"	Call

Note: Second number indicates thread size.



UNIVERSAL VALVE STUB - MIPT INLET PLATED STEEL STEM

Part No.	Size	Price
UVS-STM3002	3" x 2"	\$77.06
UVS-STM3003	3" x 3"	\$91.56
UVS-STM4003	4" x 3"	\$95.44
UVS-STM4004	4" x 4"	\$105.92
UVS-STM5005	5" x 5"	\$169.74
UVS-STM6006	6" x 6"	\$202.48
UVS-STM8008	8" x 8"	\$402.79

Note: Second number indicates thread size.



UNIVERSAL VALVE STUB - MIPT INLET STAINLESS STEEL STEM

Part No.	Size	Price
UVS-STM3002-SS	3" x 2"	Call
UVS-STM3003-SS	3" x 3"	\$95.05
UVS-STM4003-SS	4" x 3"	Call
UVS-STM4004-SS	4" x 4"	\$108.65
UVS-STM5005-SS	5" x 5"	Call
UVS-STM6006-SS	6" x 6"	\$198.98
UVS-STM8008-SS	8" x 8"	Call

Note: Second number indicates thread size.



WELD-ON VALVE STUB WITH 3/4" RVTC BRASS STEM

Part No.	Size	Length	Price
SRVML406	4"	6"	\$128.30
SRVML412	4"	12"	\$158.70
SRVML506	5"	6"	Call
SRVML512	5"	12"	Call
SRVML606	6"	6"	Call
SRVML612	6"	12"	Call



TRAVIS - RAINWAY ALUMINUM VALVE STUBS

PLAIN UNIVERSAL VALVE STUB WELD-ON

Part No.	Size	Price
UVS300	3"	\$68.60
UVS400	4"	\$66.08
UVS500	5"	\$106.44
UVS600	6"	\$134.95



SPECIALTY WELD-ON VALVE STUB

Part No.	Size	Price
V300	3"	\$129.14
V400	4"	\$114.89
V500	5"	\$171.62

Use with RVEO Specialty
Valve Opener - Page 37



UNIVERSAL VALVE STUB WITH WELD-ON SADDLE

Part No.	Size	Price
UVS404	4" x 4"	\$66.08
UVS405	4" x 5"	\$66.08
*UVS406	4" x 6"	\$66.08
UVS407	4" x 7"	\$66.08
*UVS408	4" x 8"	\$66.08
*UVS410	4" x 10"	\$66.08
*UVS412	4" x 12"	\$66.08



* Cast with square weld-on apron.
First digit indicates valve size.
Second digit indicates saddle size.

THREADED UNIVERSAL VALVE STUB

Part No.	Size	Price
UVS-TM3003	3" x 3"	\$83.32
UVS-TM4004	4" x 4"	\$89.59
UVS-TF3002	3" x 2"	\$82.54
UVS-TF3025	3" x 2-1/2"	\$82.54
UVS-TF3003	3" x 3"	\$82.54
UVS-TF4003	4" x 3"	\$73.28
UVS-TF4004	4" x 4"	\$84.44
UVS-TF5005	5" x 5"	\$207.48
UVS-TF6006	6" x 6"	\$254.10



TM = Threaded Male
TF = Threaded Female
First digit indicates valve size.
Second digit indicates thread size.

TRAVIS VALVE STUB REPAIR PARTS

REPAIR PARTS - UNIVERSAL VALVE STUB STEMS

Part No.	Size	Length	Material	Valve	Price
STEM-6-3/4	5/8"	6-3/4"	Plated	3" or 4"	\$5.06
STEM-6-3/4-BRS	5/8"	6-3/4"	Brass	3" or 4"	\$16.62
STEM-6-3/4-SS	5/8"	6-3/4"	Stainless	3" or 4"	\$20.32
STEM-9	5/8"	9"	Plated	5" or 6"	\$11.02
STEM-9-BRS	5/8"	9"	Brass	5" or 6"	\$24.34
STEM-9-SS	5/8"	9"	Stainless	5" or 6"	\$27.71
STEM-11	1"	11"	Plated	8"	\$48.35
*RVTC	3/4"	6-5/8"	Brass	4" - 6"	\$26.76

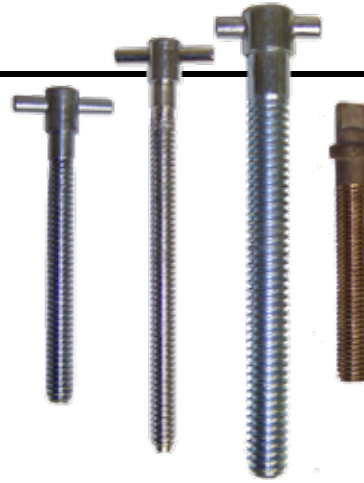

* For Rainway Valve Stubs.

DOMED DISC FOR UNIVERSAL VALVE STUBS

Part No.	Valve	Hole	Price
DOMED DISC 3	3"	5/8"	\$16.16
DOMED DISC 4	4"	5/8"	\$9.35
DOMED DISC 5	5"	5/8"	\$20.50
DOMED DISC 6	6"	5/8"	\$31.40
DOMED DISC 8	8"	1"	\$80.54



FLAT DISC FOR UNIVERSAL VALVE STUBS

Part No.	Valve	Hole	Price
FLAT DISC-3-1/2	3"	1/2"	\$17.80
FLAT DISC-3-5/8	3"	5/8"	\$17.80
FLAT DISC-3-3/4	3"	3/4"	\$17.80
FLAT DISC-4-1/2	4"	1/2"	\$20.38
FLAT DISC-4-5/8	4"	5/8"	\$20.38
FLAT DISC-4-3/4	4"	3/4"	\$20.38
*FLAT DISC-4-SR	4"	5/8"	\$23.15
FLAT DISC-5-5/8	5"	5/8"	\$23.15
FLAT DISC-5-3/4	5"	3/4"	\$34.75
FLAT DISC-6-5/8	6"	5/8"	\$34.75
FLAT DISC-6-3/4	6"	3/4"	\$33.20



* For Sure Rane Valve Stub.

WELD IN STEEL SPIDER FOR UNIVERSAL VALVE STUB

PERMANENT		
Part No.	Valve Size	Price
WSS-3	3"	Call
WSS-4	4"	\$16.70
WSS-5	5"	\$19.18

PERMANENT HEAVY DUTY		
Part No.	Valve Size	Price
WSS3HD	3"	\$16.40
WSS4HD	4"	\$23.22
WSS5HD	5"	\$34.19
WSS6HD	6"	\$32.11
WSS8HD	8"	\$68.51

REPLACEABLE		
Part No.	Valve Size	Price
WSS4RP	4"	\$20.14



PIERCE VALVE STUB REPAIR PARTS

VALVE STUB STEM - PLATED STEEL

Part No.	Size	Length	Valve	Price
P2086-01	5/8"	6-34"	3" or 4"	\$13.20
P2086-02	5/8"	9"	5" or 6"	\$15.00
P2114-01	1"	11-1/4"	8"	\$48.00
P2114-02	1"	14"	10"	\$55.20



VALVE STUB STEM - STAINLESS STEEL

Part No.	Size	Length	Valve	Price
P2086-03	5/8"	6-34"	3" or 4"	\$20.40
P2086-04	5/8"	9"	5" or 6"	\$24.00
P2114-21	1"	12"	8" or 10"	\$72.00

VALVE STUB DISC

Part No.	Valve	Hole	Price
P1059-01	3"	5/8"	\$16.80
P1060-01	4"	5/8"	\$18.00
P1061-01	5"	5/8"	\$21.60
P1062-01	6"	5/8"	\$28.80
P1063-01	8"	1"	\$74.40
P1063-02	10"	1"	\$86.40



ALUMINUM BAND & LATCH MAINLINE FITTINGS

TRAVIS RAINWAY MAINLINE FITTINGS

PRESS-ON COUPLER WITH BAND & LATCH ASSEMBLY

Part No.	Size	Price
PSECL400	4"	\$56.34
PSECL500	5"	\$66.90
PSECL600	6"	\$76.70

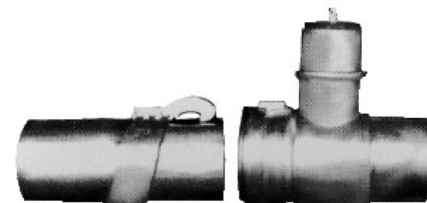

PRESS-ON UNIVERSAL VALVE TEE WITH BAND & LATCH ASSEMBLY

Part No.	Size	Price
UVTL-P333	3" x 3" x 3"	\$144.30
UVTL-P444	4" x 4" x 4"	\$158.64
UVTL-P554	5" x 5" x 4"	\$161.54
UVTL-P664	6" x 6" x 4"	\$186.41

PRESS-ON COUPLER ONLY

Part No.	Size	Price
PSEC400	4"	\$47.94
PSEC500	5"	\$52.84
PSEC600	6"	\$54.24

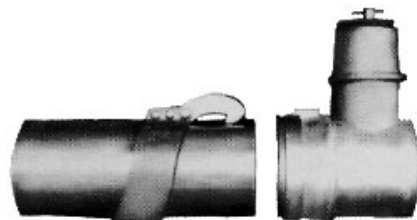

WELD-ON UNIVERSAL VALVE TEE WITH BAND & LATCH ASSEMBLY

Part No.	Size	Price
UVTL-W444	4" x 4" x 4"	\$161.53
UVTL-W554	5" x 5" x 4"	\$178.79
UVTL-W664	6" x 6" x 4"	\$191.99

WELD-ON QUICK LATCH COUPLER WITH BAND & LATCH ASSEMBLY

Part No.	Size	Price
SECL300	3"	\$32.66
SECL400	4"	\$38.03
SECL500	5"	\$53.62
SECL600	6"	\$59.11
SECL700	7"	\$67.74
SECL800	8"	\$75.96
SECL1000	10"	\$88.18

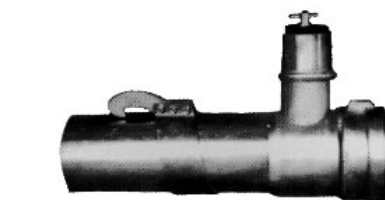

IN-LINE UNIVERSAL VALVE TEE WITH BAND & LATCH ASSEMBLY

Part No.	Size	Price
UVTL-L333	3" x 3" x 3"	\$162.24
UVTL-L444	4" x 4" x 4"	\$181.36
UVTL-L554	5" x 5" x 4"	\$217.82
UVTL-L664	6" x 6" x 4"	\$232.67

WELD-ON QUICK LATCH COUPLER ONLY

Part No.	Size	Price
SEC300	3"	\$25.79
SEC400	4"	\$29.66
SEC500	5"	\$36.41
SEC600	6"	\$38.90
SEC700	7"	\$45.46
SEC800	8"	\$52.21
SEC1000	10"	\$64.13



ALUMINUM BAND & LATCH GATED PIPE COUPLERS

WELD-ON RING TYPE COUPLER WITH ROUND BACK GASKET

Part No.	Size	Price
RBC600	6"	\$26.05
RBC700	7"	\$28.97
RBC800	8"	\$33.65
RBC1000	10"	\$43.40
RBC1200	12"	\$121.57



WELD-ON RING TYPE COUPLER WITH SQUARE BACK GASKET

Part No.	Size	Price
RC600	6"	\$22.97
RC800	8"	\$25.43
RC1000	10"	\$33.38

TRAVIS A&M LATERAL LINE FITTINGS

PRESS-IN LATERAL COUPLER WITH BAND & LATCH ASSEMBLY

Part No.	Size	Price
CX2234	2"	\$37.60
CX3334	3"	\$40.15
CX4434	4"	\$52.13
CX5534	5"	\$82.86
CX6634	6"	\$106.24

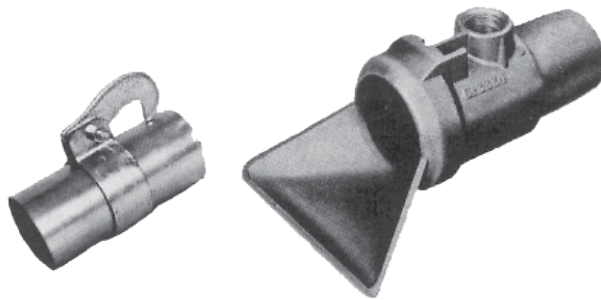

WELD-ON LATERAL COUPLER WITH BAND & LATCH ASSEMBLY

Part No.	Size	Price
CX3334W	3"	\$36.48
CX4434W	4"	\$47.18

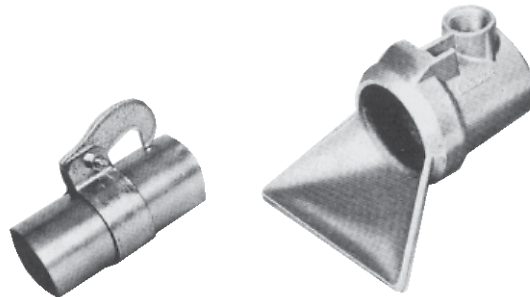

DETACHABLE LATERAL COUPLER WITH 2 BAND & LATCH ASSEMBLIES

Part No.	Size	Price
CX2230	2"	\$58.57
CX3330	3"	\$75.94
CX4430	4"	\$80.56
CX5530	5"	\$111.56
CX6630	6"	\$134.16

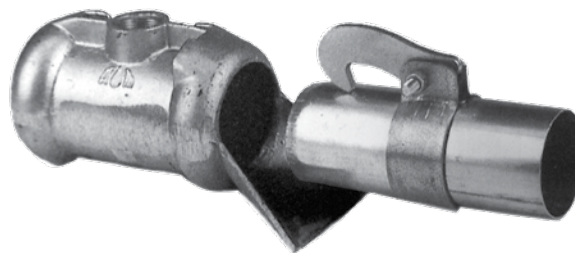

DROP-LOCK LATERAL COUPLER WITH MALE END DROP-LOCK

Part No.	Size	Price
PLCR300	3"	\$36.41



DISCHARGE ADAPTER

Part No.	Size	Price
D3011/2X2	1-1/2" x 2"	\$80.80
D30112X3	1-1/2" x 3"	\$128.40
D302X2	2" x 2"	\$81.88
D302X3	2" x 3"	\$128.40
D302X4	2" x 4"	\$124.76
D303X3	3" x 3"	\$84.58
D303X4	3" x 4"	\$154.67
D303X5	3" x 5"	\$155.93
D303X6	3" x 6"	\$187.16
D304X4	4" x 4"	\$106.92
D304X5	4" x 5"	\$158.34
D304X6	4" x 6"	\$183.23
D305X5	5" x 5"	\$183.23
D305X6	5" x 6"	\$183.23
D306X6	6" x 6"	\$180.45
D306X7	6" x 7"	\$191.02
D306X8	6" x 8"	\$218.34

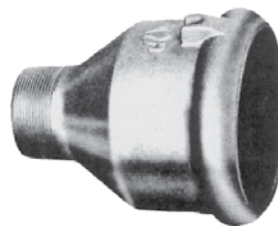

TRAVIS A&M LATERAL LINE FITTINGS

REVERSIBLE 45° MALE-FEMALE ELBOW

Part No.	Size	Price
E2232	2"	\$109.90
E3332	3"	\$121.58
E4432	4"	\$147.73
E5532	5"	\$248.89
E6632	6"	\$266.47

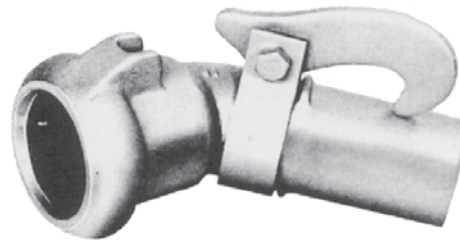

REVERSIBLE 90° MALE-FEMALE ELBOW

Part No.	Size	Price
E2231	2"	\$74.58
E3331	3"	\$89.63
E4431	4"	\$114.79
E5531	5"	\$216.05
E6631	6"	\$233.62

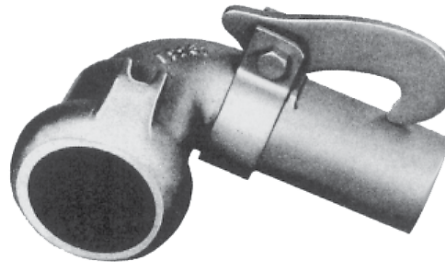

END TEE

Part No.	Size	Price
*FTO200A	2"	\$103.32
*FTO300A	3"	\$118.06
*FTO400A	4"	\$209.95
T55531	5"	\$311.64
T66631	6"	\$337.48

*RAINWAY Fitting with A&M Latch.



REVERSIBLE IN-LINE TEE

Part No.	Size	Price
*RFLT200A	2"	\$113.81
*RFLT300A	3"	\$135.12
*RFLT400A	4"	\$184.13
T55532	5"	\$318.49
T66632	6"	\$335.12

*RAINWAY Fitting with A&M Latch.

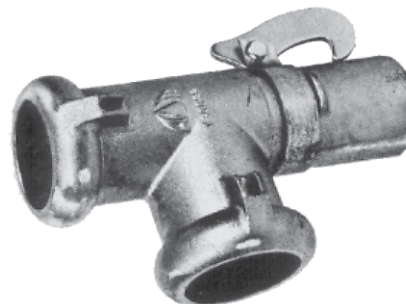

DETACHABLE REDUCER

Part No.	Size	Price
*CR302A	3" x 2"	\$71.54
*CR403A	4" x 3"	\$75.58
R5430	5" x 4"	\$166.90
R6430	6" x 4"	\$175.68
R6530	6" x 5"	\$184.39

*RAINWAY Fitting with A&M Latch.

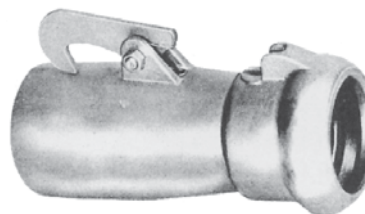

DETACHABLE END PLUG

Part No.	Size	Price
EP20	2"	\$30.38
EP30	3"	\$34.80
EP40	4"	\$49.81

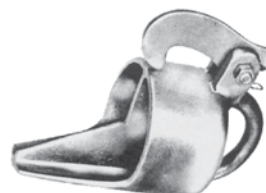

TRAVIS RAINWAY LATERAL LINE FITTINGS

PRESS-ON QUICK LATCH COUPLER

Part No.	Size	Price
PSECR200	2"	\$37.60
PSECR300	3"	\$40.15
PSECR400	4"	\$52.13

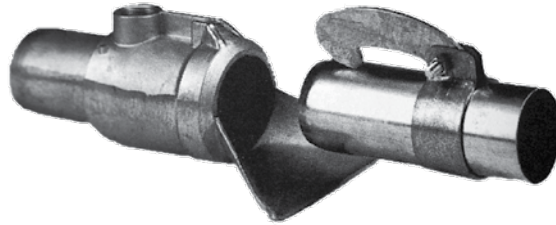

WELD-ON QUICK LATCH COUPLER

Part No.	Size	Price
SECR300	3"	\$36.48
SECR400	4"	\$47.18
SECR500	5"	\$64.06
SECR600	6"	\$76.64



CLAMP-ON QUICK LATCH COUPLER

Part No.	Size	Price
CLO200	2"	\$49.96
CLO300	3"	\$63.65
CLO400	4"	\$78.24
CLO500	5"	\$105.80
CLO600	6"	\$125.81

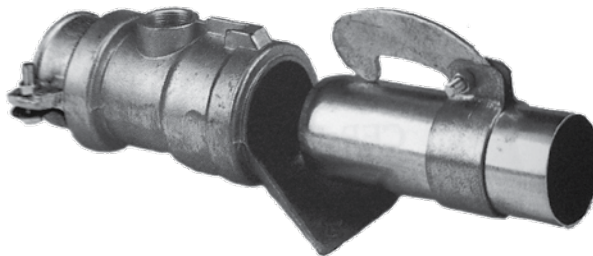

45° REVERSIBLE FIELD ELBOW

Part No.	Size	Price
RFEO200-45	2"	Call
RFEO300-45	3"	Call
RFEO400-45	4"	Call
RFEO500-45	5"	Call
RFEO600-45	6"	Call



90° REVERSIBLE FIELD ELBOW

Part No.	Size	Price
RFEO200	2"	\$68.93
RFEO300	3"	\$89.63
RFEO400	4"	\$114.79
RFEO500	5"	\$216.05
RFEO600	6"	\$233.62



TRAVIS RAINWAY LATERAL LINE FITTINGS

REVERSIBLE LINE TEE

Part No.	Size	Price
RFLT200	2"	\$113.80
RFLT300	3"	\$139.36
RFLT400	4"	\$184.13
RFLT500	5"	\$318.49
RFLT600	6"	\$335.14



FIELD TEE - END TYPE

Part No.	Size	Price
FTO200	2"	\$103.30
FTO300	3"	\$118.06
FTO400	4"	\$209.92
FTO500	5"	\$311.64
FTO600	6"	\$337.48



REDUCER

Part No.	Size	Price
CR302	3" x 2"	\$71.54
CR403	4" x 3"	\$75.58
CR504	5" x 4"	\$166.02
CR604	6" x 4"	\$175.68
CR605	6" x 5"	\$184.39



RISER GROMMET ASSEMBLY

Part No.	Size	Price
RG300	3"	\$28.81
RG400	4"	\$32.38
RG500	5"	\$39.42
RG600	6"	\$49.44



END PLUG

Part No.	Size	Price
CEP200	2"	\$30.38
CEP300	3"	\$34.80
CEP400	4"	\$49.74
CEP500	5"	\$66.32
CEP600	6"	\$71.53



Intro 1 - Pivot 2 - Valves 3 - Surface 4 - IPS Epoxy / Galv 5 - Sudipn Fittings 6 - PVC Fittings 7 - Sprinklers 8 - Malleable 9 - Hose 10 - Injectors / Filters 11 - Low Volume Formulas / TC

TRAVIS A&M SOLID SET FITTINGS

DROP-LOCK / DRAGLINE TOWABLE COUPLER

Part No.	Size	Price
WDLC300	3"	\$41.29
WML300	3"	\$5.47

Weld-On coupler w/ 3/4" outlet, half band & gasket



DROP-LOCK / DRAGLINE TOWABLE COUPLER WITH MALE END

Part No.	Size	Price
WDL-ME-300	3"	\$53.11
ME-300	3"	\$18.50

Weld-On coupler w/ 3/4" outlet, gasket & male end



DROP-LOCK / DRAGLINE END PLUG

Part No.	Size	Price
PLC300	3"	\$29.76

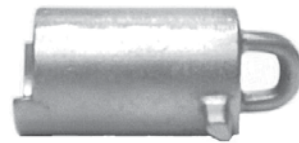

DROP-LOCK / DRAGLINE LATCH ADAPTER

Part No.	Size	Price
LA367	3"	\$30.26

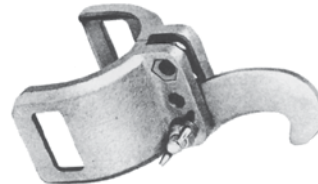

STEEL BOLT-ON CENTER LINE RISER

Part No.	Size	Price
SCR300	3"	\$18.50
SCR400	4"	\$19.67



STEEL FOOT FOR BOLT-ON CENTER LINE RISER

Part No.	Size	Price
F30	3"	\$1.86
F40	4"	\$1.90



TRAVIS RAINWAY SOLID SET FITTINGS

RAINWAY SOLID SET COUPLER

Part No.	Coupler Size	Outlet Size	Price
PSCS300-100	3"	1"	\$36.17
PSCS300-075	3"	3/4"	\$36.17

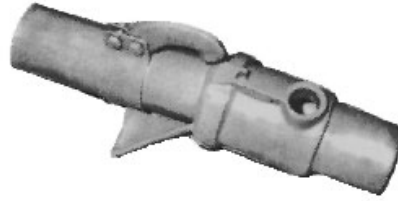

PRESS-ON POSITIVE LOCK COUPLER

Part No.	Size	Price
PLCR200	2"	\$49.46
PLCR300	3"	\$36.41
PLCR400	4"	\$56.82
*PLML200	2"	\$13.56
*PLML300	3"	\$7.67
*PLML400	4"	\$17.99

* Male latch only.



POSITIVE LOCK END PLUG

Part No.	Size	Price
PLC200	2"	\$35.27
PLC300	3"	\$29.76
PLC400	4"	\$60.71



RAIN FOR RENT TYPE WELD-ON COUPLER

Part No.	Size	Price
RFR300W	3"	\$36.59



PRESS-IN CENTER OUTLET

Part No.	Size	Price
PCR300	3"	\$32.95
PCR400	4"	\$39.90



BAND & LATCH ASSEMBLY

PIERCE

Part No.	Size	Price
P1034-01	2"	\$9.46
P1035-01	3"	\$9.90
P1036-81	4"	\$16.20
P1036-82	5"	\$17.40
P1036-83	6"	\$22.80
P1037-82	8"	\$43.20



TRAVIS - PIERCE TYPE

Part No.	Size	Price
PBL200	2"	\$10.52
PBL300	3"	\$10.91
PBL400	4"	\$12.89
PBL500	5"	\$18.35
PBL600	6"	\$20.34
PBL700	7"	\$23.89
PBL800	8"	\$25.97
PBL1000	10"	\$30.35



TRAVIS RAINWAY

Part No.	Size	Price
RWBL200	2"	\$10.52
RWBL300	3"	\$10.91
RWBL400	4"	\$12.89
RWBL500	5"	\$18.35
RWBL600	6"	\$20.34
RWBL700	7"	\$23.30
RWBL800	8"	\$25.98



TRAVIS A&M

Part No.	Size	Price
BL200	2"	\$10.52
BL300	3"	\$10.91
BL400	4"	\$12.89
BL500	5"	\$18.35
BL600	6"	\$20.29
BL700	7"	\$23.30
BL800	8"	\$25.97
BL1000	10"	\$28.25



PARTS & ACCESSORIES

PIERCE FULL BAND ONLY

Part No.	Size	Price
P1021-01	2"	\$4.56
P1022-01	3"	\$6.36
P1023-01	4"	\$7.92
P1023-02	5"	\$11.16
P1024-01	6"	\$17.10
P1026-02	8"	\$36.90



TRAVIS FULL BAND ONLY

Part No.	Size	Price
B200	2"	\$3.34
B300	3"	\$4.06
B400	4"	\$7.20
B500	5"	\$12.26
B600	6"	\$12.64
B700	7"	\$14.69
B800	8"	\$18.47
B1000	10"	\$23.28



PIERCE MISCELLANEOUS PARTS

Part No.	Description	Price
P1012-01	Catch 2" - 4"	\$3.00
P1012-02	Catch 5" - 8"	\$3.96
P1027-01	"U" Clevis 1"	\$3.84
P1028-01	"U" Clevis 2"	\$5.52
P2028-01	Ferrule	\$2.40
P2020-05	Bolt 3/8" x 1-1/2"	\$2.00
P2034-07	Nut 3/8"	\$0.80
P2042-08	Washer 3/8"	\$0.73
P2042-11	Washer 9/16"	\$0.72
P1030-01	Universal Hook	\$4.32



TRAVIS MISCELLANEOUS PARTS

Part No.	Description	Price
HOOKBOSS-SM	Hookboss-SM	\$2.80
HOOKBOSS-LG	Hookboss-LG	\$4.00
HOOKBRKT-SM	"U" Clevis 1"	\$3.67
HOOKBRKT-LG	"U" Clevis 2"	\$4.00
FERRULE A	Ferrule 5/16"	\$0.67
FERRULE B	Ferrule 1/2"	\$0.83
9401010480	Bolt 3/8" x 1-1/4"	\$1.44
N1	Nut 3/8"	\$0.78
PIERCE HOOK	Pierce Type Hook	\$5.94
201154	Latch Spring	\$2.05



CONTACT US FOR OTHER BAND & LATCH FITTING BRANDS INCLUDING

Western Moore Rane Wade Rain
 Felco Sure Rane Redi Rain

TRAVIS A&M MAINLINE FITTINGS

PRESS-IN COUPLER WITH BAND & LATCH ASSEMBLY

Part No.	Size	Price
CX4436	4"	\$59.34
CX5536	5"	\$74.60
CX6636	6"	\$82.86

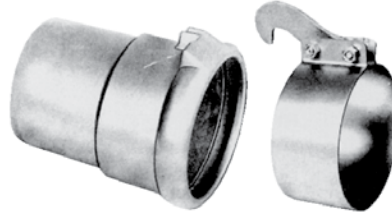

WELD-ON COUPLER WITH BAND & LATCH ASSEMBLY

Part No.	Size	Price
CX3335A	3"	\$32.66
CX4435A	4"	\$38.03
CX5535A	5"	\$53.62
CX6635A	6"	\$59.11
CX7735A	7"	\$67.74
CX8835A	8"	\$75.97
CX1035A	10"	\$88.18



DETACHABLE COUPLER WITH 2 BAND & LATCH ASSEMBLIES

Part No.	Size	Price
CX3335	3"	\$64.36
CX4435	4"	\$74.60
CX5535	5"	\$82.86
CX6635	6"	\$123.59
CX7735	7"	\$141.13
CX8835	8"	\$167.08
CX1035	10"	\$223.82

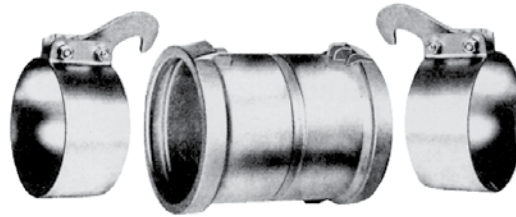

IN-LINE TEE VALVE

Part No.	Size	Price
VT4433M4	4"	\$363.14
VT5533M4	5"	\$416.39
VT6633M4	6"	\$427.85

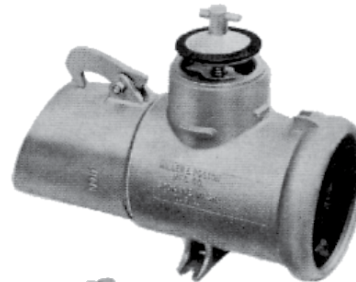

WELD-ON TEE VALVE

Part No.	Size	Price
VTX4433W	4"	\$237.53
VTX5533W	5"	\$254.56
VTX6633W	6"	\$257.65

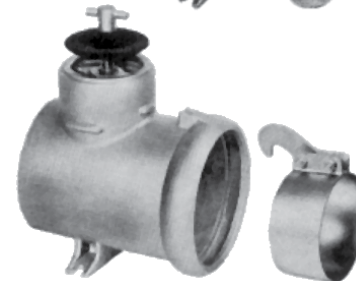

DETACHABLE TEE VALVE

Part No.	Size	Price
VTX4433	4"	\$242.71
VTX5533	5"	\$308.46
VTX6633	6"	\$314.80

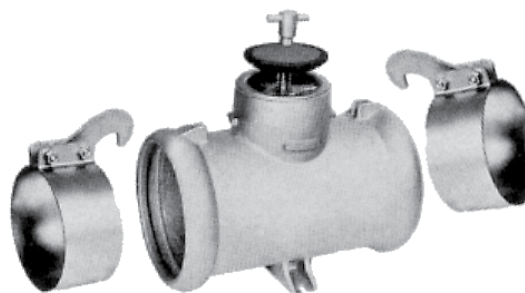

HIGH PRESSURE ALUMINUM RING LOCK FITTINGS



WELD-ON COUPLER SET

Part No.	Size	Price
HPRL400	4"	\$66.17
HPRL500	5"	\$84.62
HPRL600	6"	\$91.54
HPRL700	7"	\$110.39
HPRL800	8"	\$112.92
HPRL1000	10"	\$141.89
HPRL1200	12"	\$205.37



PRESS-ON MAINLINE COUPLER SET

Part No.	Size	Price
RLPSEC500	5"	\$101.56
RLPSEC600	6"	\$109.39



WELD-ON FEMALE END

Part No.	Size	Price
HP-F400	4"	\$28.97
HP-F500	5"	\$37.72
HP-F600	6"	\$40.75
HP-F700	7"	\$49.99
HP-F800	8"	\$51.49
HP-F1000	10"	\$64.76
HP-F1200	12"	\$99.62



PRESS-ON MAINLINE FEMALE END

Part No.	Size	Price
PSEC400	4"	\$47.94
PSEC500	5"	\$52.84
PSEC600	6"	\$54.24



WELD-ON MALE END

Part No.	Size	Price
HP-M400	4"	\$20.22
HP-M500	5"	\$25.99
HP-M600	6"	\$28.46
HP-M700	7"	\$33.91
HP-M800	8"	\$35.96
HP-M1000	10"	\$44.75
HP-M1200	12"	\$71.56

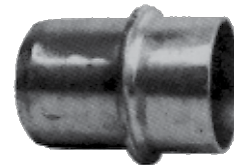

PRESS-ON MAINLINE MALE END

Part No.	Size	Price
SRLM 499	5"	\$27.19
SRLM 599	6"	\$29.38

HIGH PRESSURE ALUMINUM RING LOCK FITTINGS



WELD-ON MALE END RING

Part No.	Size	Price
R600	6"	\$15.56
R800	8"	\$18.78
R1000	10"	\$24.26

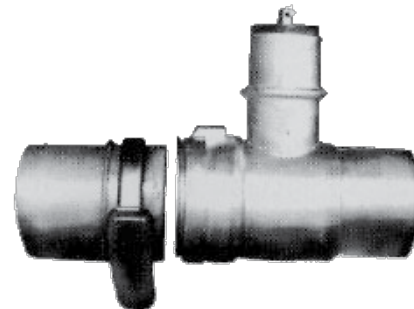

PRESS-ON UNIVERSAL VALVE TEE

Part No.	Size	Price
RLUVT-P554	5" x 5" x 4"	\$217.06
RLUVT-P664	6" x 6" x 4"	\$217.06



WELD-ON UNIVERSAL VALVE TEE

Part No.	Size	Price
RLUVT-W554	5" x 5" x 4"	\$217.06
RLUVT-W664	6" x 6" x 4"	\$217.06

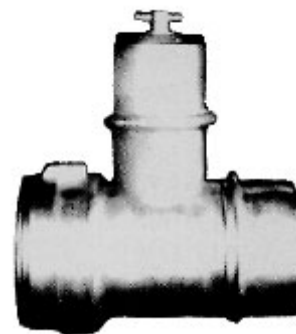

IN-LINE UNIVERSAL VALVE TEE

Part No.	Size	Price
RLUVT-L554	5" x 5" x 4"	\$231.92
RLUVT-L664	6" x 6" x 4"	\$241.06



MAINLINE FIELD TEE

Part No.	Size	Price
HPFT400	4"	\$184.28
HPFT500	5"	\$227.98
HPFT600	6"	\$249.86
HPFT700	7"	\$407.08
HPFT800	8"	\$308.56
HPFT1000	10"	\$405.84



MAINLINE END TEE

Part No.	Size	Price
HPET400	4"	\$184.28
HPET500	5"	\$227.98
HPET600	6"	\$249.86
HPET700	7"	\$407.08
HPET800	8"	\$308.56
HPET1000	10"	\$405.84

ALUMINUM RING LOCK FITTINGS

HIGH PRESSURE ALUMINUM RING LOCK FITTINGS

MAINLINE 90° ELBOW

Part No.	Size	Price
HPFE400	4"	\$128.74
HPFE500	5"	\$165.80
HPFE600	6"	\$186.73
HPFE700	7"	\$243.01
HPFE800	8"	\$231.25
HPFE1000	10"	\$321.76

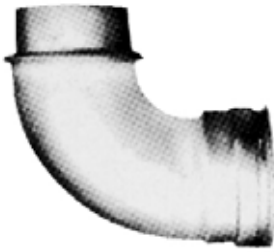

MAINLINE REDUCER

Part No.	Size	Price
HPR405	4" x 5"	\$89.16
HPR406	4" x 6"	\$104.05
HPR506	5" x 6"	\$109.96
HPR607	6" x 7"	\$120.41
HPR608	6" x 8"	\$148.39
HPR708	7" x 8"	\$134.81
HPR8010	8" x 10"	\$190.57
HPR1012	10" x 12"	\$246.12



END PLUG

Part No.	Size	Price
HPEP600	6"	\$100.73
HPEP700	7"	\$118.97
HPEP800	8"	\$120.80
HPEP1000	10"	\$173.18



STEEL RING LOCK FITTINGS

HIGH PRESSURE RING LOCK CLAMPS

PIERCE

Part No.	Size	Price
P2123-08	4"	\$18.00
P2123-01	5"	Call
P2123-02	6"	\$21.60
P2123-03	8"	\$24.00
P2123-04	10"	\$28.80
P2123-05	12"	\$36.00



TRAVIS

Part No.	Size	Price
HPRLC300	3"	\$21.40
HPRLC400	4"	\$23.04
HPRLC500	5"	\$23.81
HPRLC600	6"	\$25.78
*HPRLC600TL	6"	\$28.33
HPRLC700	7"	\$30.36
HPRLC800	8"	\$27.83
*HPRLC800TL	8"	\$30.67
HPRLC1000	10"	\$34.40
HPRLC1200	12"	\$40.76



* Oversized to fit gated pipe bell couplers.

TRAVIS GALVANIZED SURGE PLUG

Part No.	Size	Price
SRL-SP400	4"	\$239.21
SRL-SP500	5"	\$249.29
SRL-SP600	6"	\$255.55
SRL-SP700	7"	\$275.17
SRL-SP800	8"	\$314.24
SRL-SP1000	10"	\$351.12



ALUMINUM TWIST LOCK FITTINGS

HIGH PRESSURE ALUMINUM TWIST LOCK FITTINGS

WELD-ON TWIST LOCK COUPLER

Part No.	Size	Price
*TL600	6" Coupler Set	\$93.89
TLF600	6" Female Only	\$62.11
TLM600	6" Male End Ring	\$32.05
TLMF600	6" Male End Full	\$62.11
TLG	6" Gasket	Call

* Includes Female & Ring Type Male.



DISCHARGE ADAPTER (GALVANIZED, STEEL)

Part No.	Size	Price
TLSDA-404	4" Mipt x 4" Fem.	\$178.49
TLSDA-406	4" Mipt x 6" Fem.	\$216.16
TLSDA-506	5" Mipt x 6" Fem.	Call
TLSDA-606	6" Mipt x 6" Fem.	\$259.41



LINE TEE

Part No.	Size	Price
IK212106	6"	\$352.57



END TEE

Part No.	Size	Price
IK213106	6"	\$352.57



90° ELBOW

Part No.	Size	Price
IK214106	6"	\$253.14



45° ELBOW

Part No.	Size	Price
IK215106	6"	\$230.57



END PLUG

Part No.	Size	Price
IK217106	6"	\$104.00

HOLD BANDS & REPAIR SLEEVES



STEEL HOLD BANDS

Part No.	Size	Price
SHB-4	4"	\$3.17
SHB-5	5"	\$3.56
SHB-10	10"	Call
SHB-12	12"	Call



ALUMINUM HOLD BANDS

Part No.	Size	Price
HB-300	3"	\$3.19
HB-400	4"	\$3.95
HB-500	5"	\$5.32
HB-600	6"	\$7.26
HB-800	8"	\$11.06
HB-1000	10"	Call
HB-1200	12"	Call



STEEL REPAIR SLEEVE

Part No.	Size	Price
SRS300L	3"	Call
SRS400L	4"	\$17.18
SRS500L	5"	Call
SRS600	6"	\$26.80
SRS700	7"	Call
SRS800	8"	Call
SRS1000	10"	Call

Aprrx. 10" Length

WELD-ON FITTINGS - ALUMINUM

BAND & LATCH & RING LOCK MALE END



Part No.	Size	Weight Lbs.	Price
RFE0500-ME	5"	2.50	\$63.46
RFE0600-ME	6"	3.25	\$65.81

END PLUG COVER

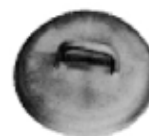

Part No.	Size	Weight Lbs.	Price
WEPC600	6"	1.50	\$58.14
WEPC700	7"	2.25	Call
WEPC800	8"	2.50	\$78.19
WEPC1000	10"	3.25	\$89.70

LATCH POCKET



Part No.	Size	Weight Lbs.	Price
WLP34	3" & 4"	.20	\$6.79
WLP56	5" & 6"	.25	\$7.44

CAST CONCENTRIC CONE



Part No.	Size	Weight Lbs.	Price
DC1004	1-1/2" x 4"	1.25	\$34.14
DC1006	1-1/4" x 6"	2.50	\$57.61
AWC210	*2" x 10"	2.50	\$74.96

* Stepped Style

HOOK BRACKET

WHB		.30	\$7.82
-----	--	-----	--------



CONCENTRIC CONE

Part No.	Size	Weight Lbs.	Price
WC406	4" x 6"	1.75	\$37.76
WC608	6" x 8"	2.25	\$51.13
WC8010	8" x 10"	4.00	\$67.98
WC1012	10" x 12"	6.00	\$100.13



CAST ECCENTRIC CONE

Part No.	Size	Weight Lbs.	Price
ESA1503	1-1/2" x 3"	1.25	\$53.66
ESA1504	1-1/2" x 4"	2.00	\$59.56
ESA1505	1-1/2" x 5"	2.75	\$86.04
ESA2506	2-1/2" x 6"	3.25	\$95.50
ESA3008	3" x 8"	5.25	\$134.71



HALF NIPPLE

Part No.	Size	Weight Lbs.	Price
NA050	1/2"	.19	\$8.47
NA075	3/4"	.19	\$8.86
NA100	1"	.19	\$9.74
NA125	1-1/4"	.25	\$11.87
NA150	1-1/2"	.28	\$17.26
NA200	2"	.31	\$24.16
NA250	2-1/2"	.38	\$42.11
NA300	3"	.57	\$41.53
NA400	4"	.88	\$51.64
NA500	5"	1.13	\$64.82
NA600	6"	1.38	\$93.14
NA800	8"	3.00	\$153.10



HALF COUPLER

Part No.	Size	Weight Lbs.	Price
HC050	1/2"	.25	\$8.47
HC075	3/4"	.25	\$8.86
HC100	1"	.32	\$9.74
HC125	1-1/4"	.44	\$11.87
HC150	1-1/2"	.50	\$17.26
HC200	2"	1	\$24.16
HC250	2-1/2"	1	\$42.11
HC300	3"	1.40	\$41.53
HC400	4"	1.50	\$68.10
HC500	5"	1.50	\$129.88
HC600	6"	1.60	\$184.85

WELD-ON FITTINGS - ALUMINUM



TEE

Part No.	Size	Weight Lbs.	Price
WT333	3" x 3" x 3"	1.50	\$93.59
WT444	4" x 4" x 4"	2.00	\$93.59
WT555	5" x 5" x 5"	2.50	\$102.23
WT666	6" x 6" x 6"	3.00	\$115.09
WT888	8" x 8" x 8"	5.75	\$158.12
WT101010	10" x 10" x 10"	8.00	\$189.91



45° ELBOW

Part No.	Size	Weight Lbs.	Price
WE4-3	3"	1.00	\$35.58
WE4-4	4"	1.00	\$36.91
WE4-5	5"	1.50	\$51.84
WE4-6	6"	2.00	\$62.68
WE4-8	8"	3.50	\$76.80
WE4-10	10"	4.75	\$112.14



90° ELBOW

Part No.	Size	Weight Lbs.	Price
WE9-3	3"	1.50	\$60.02
WE9-4	4"	1.74	\$65.17
WE9-5	5"	2.25	\$85.18
WE9-6	6"	4.00	\$102.83
WE9-8	8"	6.00	\$123.31
WE9-10	10"	9.50	\$188.33



FLANGE

Part No.	Size	Weight Lbs.	Price
APF300	3"	3.00	\$76.91
APF400	4"	4.00	\$80.39
APF500	5"	5.00	\$86.16
APF600	6"	6.00	\$94.76
APF800	8"	7.75	\$125.74
APF1000	10"	12.00	\$173.53
APF1200	12"	17.00	\$284.77
APF1400	14"	20.00	\$566.04

LOW PRESSURE ALUMINUM HOSE BARB FITTINGS



MALE BAND & LATCH X HOSE BARB

Part No.	Size	Price
HAX44	4"	\$50.66



WELD-ON HOSE BARB

Part No.	Size	Price
CAHB-6	6"	\$59.26
CAHB-8	8"	\$81.53

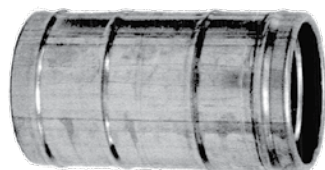

HOSE REPAIR SPLICE

Part No.	Size	Price
ARP2	2"	\$20.48
ARP3	3"	\$29.90
ARP4	4"	\$36.92
ARP6	6"	\$39.60
ARP8	8"	\$41.32
ARP10	10"	Call



REDUCING HOSE REPAIR SPLICE

Part No.	Size	Price
ARS32	3" x 2"	\$43.04
ARS43	4" x 3"	\$54.24
ARS64	6" x 4"	\$63.34
ARS86	8" x 6"	\$72.16

GALVANIZED FEMALE BAND & LATCH X HOSE BARB

PIERCE

Part No.	Size	Price
P1788-61	2"	\$40.80
P1788-62	3"	\$42.00
P1788-63	4"	\$49.20
P1788-64	5"	\$66.00
P1788-65	6"	\$75.60



TRAVIS

Part No.	Size	Price
BLSHF200	2"	\$36.12
BLSHF300	3"	\$42.37
BLSHF400	4"	\$47.77
BLSHF500	5"	\$69.61
BLSHF600	6"	\$79.84
BLSHF800	8"	\$99.77

GALVANIZED MALE BAND & LATCH X HOSE BARB

PIERCE

Part No.	Size	Price
P1791-01	2"	\$48.00
P1791-02	3"	\$49.20
P1791-04	4"	\$52.80
P3150-04	4" w/ floating band	Call
P1791-06	5"	\$76.80
P1791-07	6"	\$86.40



TRAVIS

Part No.	Size	Price
BLSHM200	2"	\$41.28
BLSHM300	3"	\$37.58
BLSHM400	4"	\$47.53
BLSHM500	5"	\$82.66
BLSHM600	6"	\$101.70
BLSHM800	8"	\$127.08

GALVANIZED FEMALE RING LOCK X HOSE BARB

PIERCE

Part No.	Size	Price
P1842-62	4"	\$48.00
P1842-64	6"	\$69.60
P1842-65	8"	\$103.20
P1842-66	10"	\$129.60



TRAVIS

Part No.	Size	Price
SRLHF300	3"	\$34.31
SRLHF400	4"	\$40.35
SRLHF500	5"	\$57.49
SRLHF600	6"	\$58.73
SRLHF800	8"	\$91.08
SRLHF1000	10"	\$113.08

GALVANIZED FEMALE RING LOCK X HOSE BARB REDUCER



TRAVIS

Part No.	Size	Price
SRLHF604	6" x 4"	\$82.49
SRLHF604.5	6" x 4-1/2"	\$88.73
SRLHF806	8" x 6"	\$146.21

GALVANIZED MALE RING LOCK X HOSE BARB

PIERCE

Part No.	Size	Price
P1843-02	4"	\$50.40
P1843-04	6"	\$79.20
P1843-05	8"	\$105.60
P1843-06	10"	\$132.00



TRAVIS

Part No.	Size	Price
SRLHM300	3"	\$32.10
SRLHM400	4"	\$38.85
SRLHM500	5"	\$57.49
SRLHM600	6"	\$55.86
SRLHM800	8"	\$95.15
SRLHM1000	10"	\$107.20

GALVANIZED MALE RING LOCK X HOSE BARB REDUCER



TRAVIS

Part No.	Size	Price
SRLHM603	6" x 3"	\$74.87
SRLHM604	6" x 4"	\$82.42
SRLHM604.5	6" x 4-1/2"	\$86.73
SRLHM605	6" x 5"	\$89.22
SRLHM806	8" x 6"	\$146.21

BAUER STYLE FITTINGS

S1 GALVANIZED WELD ON STEEL BALL (MALE)

Part No.	Description	Price
1010132	2" Ball	\$10.27
1090132	3" Ball	\$12.23
1050132	4" Ball	\$31.31
1100132	5" Ball	Call
1070132	6" Ball	\$52.83
1080132	8" Ball	\$88.05



S2 GALVANIZED STEEL LEVER (CLOSURE RING)

Part No.	Description	Price
1010134	2" Closure Lever	\$22.75
1030134	3" Closure Lever	\$37.49
1050134	4" Closure Lever	\$59.47
1060134	6" Closure Lever	\$111.33
1080134	8" Closure Lever	\$190.32
1310134	10" Closure Lever	\$78.48
1320134	12" Closure Lever	\$144.08



S3 GALVANIZED STEEL SOCKET WELD ON FEMALE END

Part No.	Description	Price
1010133	2" Socket	\$10.27
1090133	3" Socket	\$12.23
1050133	4" Socket	\$32.78
1100133	5" Socket	\$39.63
1070133	6" Socket	\$58.70
1080133	8" Socket	\$94.90
1310134	10" Socket	\$78.48



S4 SEALING RING

Part No.	Description	Price
1010140	2" Sealing Ring	\$3.83
1030140	3" Sealing Ring	\$4.46
1050140	4" Sealing Ring	\$6.69
1100140	5" Sealing Ring	\$10.61
1070140	6" Sealing Ring	\$13.39
1080140	8" Sealing Ring	\$17.84
1310140	10" Sealing Ring	\$25.04
1320140	12" Sealing Ring	\$28.16



BAUER STYLE FITTINGS

S1 BLACK STEEL BALL (WELD ON MALE END)

Part No.	Description	Price
1010182	2" Ball	\$6.16
1090182	3" Ball	\$6.80
1050182	4" Ball	\$15.09
1100182	5" Ball	\$19.04
1070182	6" Ball	\$24.65
1080182	8" Ball	\$46.33
1310182	10" Ball	\$66.76
1320182	12" Ball	\$118.89



S2 BLACK STEEL LEVER

Part No.	Description	Price
1010184	2" Lever	\$18.28
1030184	3" Lever	\$29.33
1050184	4" Lever	\$45.48
1100184	5" Lever	\$69.07
1060184	6" Lever	\$83.74
1080184	8" Lever	\$150.04
1310184	10" Steel Ring	\$54.95
1320184	12" Steel Ring	\$97.63



S3 BLACK STEEL SOCKET WELD ON FEMALE END

Part No.	Description	Price
1010183	2" Socket	\$6.38
1090183	3" Socket	\$7.23
1050183	4" Socket	\$15.73
1100183	5" Socket	\$22.59
1070183	6" Socket	\$29.33
1080183	8" Socket	\$56.96
1310183	10" Socket	\$126.74
1320183	12" Socket	\$286.94



S11 GALVANIZED 90° ELBOW MALE X FEMALE

Part No.	Description	Price
1011101	2" 90° Elbow	Call
1091101	3" 90° Elbow	\$153.46
1051101	4" 90° Elbow	\$230.77
1071101	6" 90° Elbow	\$420.29
1081101	8" 90° Elbow	\$724.85
1101-10	10" 90° Elbow	\$787.25
1101-12	12" 90° Elbow	\$1,199.51



S13 GALVANIZED 45° ELBOW MALE X FEMALE

Part No.	Description	Price
1011301	2" 45° Elbow	Call
1091301	3" 45° Elbow	\$198.68
1051301	4" 45° Elbow	\$208.00
1071301	6" 45° Elbow	\$377.97
1081301	8" 45° Elbow	\$692.29
1301-10	10" 45° Elbow	\$606.75
1301-12	12" 45° Elbow	\$1,073.80



BAUER STYLE FITTINGS

S21 GALVANIZED SIDE TEE

Part No.	Description	Price
1011701	2" Tee	Call
1091701	3" Tee	Call
1051701	4" Tee	\$331.08
1071701	6" Tee	\$620.78
1081701	8" Tee	\$1,032.60
1701-10	10" Tee	\$981.19
1701-12	12" Tee	\$1,455.67



S27 GALVANIZED END TEE

Part No.	Description	Price
1011901	2" Tee	Call
1031901	3" Tee	Call
1051901	4" Tee	Call
1071901	6" Tee	Call
1081901	8" Tee	Call
1901-10	10" Tee	Call
1901-12	12" Tee	Call



S70 GALVANIZED FLANGED BALL (FLANGE X MALE)

Part No.	Description	Price
1006970	3" Flange x Ball	Call
1006987	4" Flange x Ball	\$253.28
1007005	6" Flange x Ball	\$384.08
1007003	8" Flange x Ball	\$602.80
1007010	10" Flange x Ball	\$484.20
1007012	12" Flange x Ball	\$699.20



S71 GALVANIZED BALL X FIPT (MALE X FIPT)

Part No.	Description	Price
1010211	2" Ball x FIPT	\$94.47
1090211	3" Ball x FIPT	\$169.12
1050211	4" Ball x FIPT	\$251.71
1070211	6" Ball x FIPT	\$455.44
1080211	8" Ball x FIPT	\$701.89



S72 GALVANIZED SOCKET X FIPT

Part No.	Description	Price
1010311	2" Socket x FIPT	\$71.08
1090311	3" Socket x FIPT	\$123.03
1050311	4" Socket x FIPT	\$158.40
1070311	6" Socket x FIPT	\$270.44
1080311	8" Socket x FIPT	Call



Intro 1 - Pivot 2 - Valves 3 - Surface 4 - IPS Epoxy / Galv. 5 - Sudition Fittings 6 - PVC Fittings 7 - Sprinklers 8 - Malleable 9 - Hose 10 - Injectors / Filters 11 - Low Volume Formulas / TC

BAUER STYLE FITTINGS

S73 GALVANIZED FLANGED X SOCKET (FLANGED X FEMALE)

Part No.	Description	Price
1006968	3" Flanged x Socket	Call
1006986	4" Flanged x Socket	\$143.81
1007004	6" Flanged x Socket	\$243.23
1007002	8" Flanged x Socket	\$361.71
1007310	10" Flanged x Socket	\$496.85
1007312	12" Flanged x Socket	\$795.55



S74 GALVANIZED BALL X MIPT (MALE X MIPT)

Part No.	Description	Price
1010811	2" Ball x MIPT, No Lever	\$41.23
1090820	3" Ball x MIPT, W / Lever	\$169.12
1050811	4" Ball x MIPT, No Lever	\$116.11
1070811	6" Ball x MIPT, No Lever	\$193.76
1080810	8" Ball x MIPT, No Lever	\$319.47

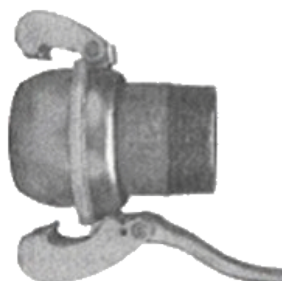

S75 GALVANIZED SOCKET X MIPT (FEMALE X MIPT)

Part No.	Description	Price
1010511	2" Socket x MIPT	\$41.23
1090521	3" Socket x MIPT	\$65.46
1050511	4" Socket x MIPT	\$96.19
1070511	6" Socket x MIPT	\$230.40
1080511	8" Socket x MIPT	\$331.84



S77 GALVANIZED HOSE BALL (MALE)

Part No.	Description	Price
1011011	2" Ball x Hose Barb	\$21.68
1091011	3" Ball x Hose Barb	\$31.45
1051011	4" Ball x Hose Barb	\$54.45
1071011	6" Ball x Hose Barb	\$95.95
1081011	8" Ball x Hose Barb	\$188.35
1311011	10" Ball x Hose Barb	\$238.92
1321011	12" Ball x Hose Barb	\$362.43



S78 GALVANIZED HOSE SOCKET (FEMALE)

Part No.	Description	Price
1010711	2" Socket x Hose Barb	\$21.68
1090711	3" Socket x Hose Barb	\$31.45
1050711	4" Socket x Hose Barb	\$54.45
1070711	6" Socket x Hose Barb	\$95.95
1080711	8" Socket x Hose Barb	\$188.35
1310711	10" Socket x Hose Barb	\$358.77
1320711	12" Socket x Hose Barb	\$598.96



GASKETS

A&M

DRAIN		
Part No.	Size	Price
320-20	2"	\$1.83
320-30	3"	\$1.89
320-40	4"	\$2.54

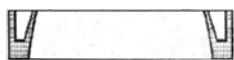

NON-DRAIN		
Part No.	Size	Price
422-20	2"	\$1.83
422-30	3"	\$1.89
422-40	4"	\$2.53
422-45	4-1/2"	\$5.24
422-50	5"	\$2.90
422-60	6"	\$3.61
422-70	7"	\$5.55
422-80	8"	\$4.43
422-100	10"	\$6.86

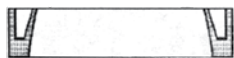

HIGH PRESSURE OR SOLID SET		
Part No.	Size	Price
522-30	3"	\$2.10
4G5	4"	Call
5G5	5"	Call
6G5	6"	Call
8G5	8"	Call
10G5	10"	Call

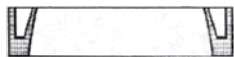

AKRON TYPE

Part No.	Size	Price
485-20	2"	\$7.73
485-30	3"	\$3.04
485-40	4"	\$3.61
485-50	5"	\$7.26
485-60	6"	\$7.51

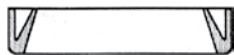

AMES ABC-Q TYPE

Part No.	Size	Price
480-20	2"	\$1.81
480-30	3"	\$1.89
480-40	4"	\$3.42
480-50	5"	\$6.16
480-60	6"	\$10.16
480-70	7"	\$24.42

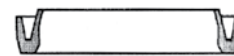

AMES TYPE SPRINGS

STANDARD		
Part No.	Size	Price
580-20	2"	\$4.73
580-30	3"	\$5.70
580-40	4"	\$6.58
580-50	5"	\$13.44
580-60	6"	\$20.46



AMES LO-HI TYPE

Part No.	Size	Price
481-60	6"	\$5.01
481-70	7"	\$21.60
481-80	8"	\$6.58
481-100	10"	\$9.69
481-120	12"	\$12.03

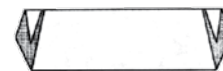

BAUER TYPE METRIC O'RING

Part No.	Size	Price
436-65	65 x 9	Call
436-82	82 x 13	Call
436-108	108 x 14	Call
436-125	125 x 14	Call
436-133	133 x 14	Call
436-153	153 x 18	Call
436-159	159 x 14	Call
436-174	174 x 18	Call
436-224	224 x 18	Call
436-255	255 x 18	Call



BEN GAR TYPE

Part No.	Size	Price
433-60	6"	\$6.59
433-70	7"	\$7.54
433-80	8"	\$6.28
433-100	10"	\$9.83



CAM-LOCK TYPE FLAT WASHERS SEALS

Part No.	Size	Price
600-05	1/2"	\$0.80
600-07	3/4"	\$0.83
600-10	1"	\$0.86
600-12	1-1/4"	\$0.80
600-15	1-1/2"	\$0.80
600-20	2"	\$0.80
600-25	2-1/2"	\$0.96
600-30	3"	\$0.96
600-40	4"	\$1.35
600-60	6"	\$2.91
600-80	8"	\$6.28

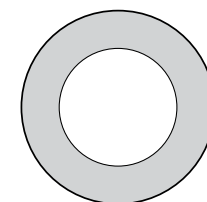

CHAMPION TYPE

Part No.	Size	Price
486-20	2"	\$2.17
*486-21	2"	\$2.23
486-30	3"	\$2.86
486-40	4"	\$3.54
486-50	5"	\$4.93
486-60	6"	\$6.38
486-80	8"	\$8.77

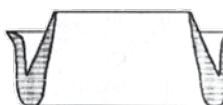

* For Aluminum Coupler 3/8" Outer Lip

GASKETS

CLEARVIEW D&K TYPE

Part No.	Size	Price
102407	2"	Call
102408	2-1/2"	Call
102409	3"	Call
102410	4"	Call
102412	5"	Call
102414	6"	Call
102418	8"	Call

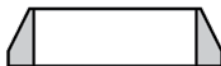

FARMLAND SBS-Q TYPE VERY SLOW DRAIN

Part No.	Size	Price
470-20	2"	\$1.81
470-30	3"	\$1.90
470-40	4"	\$2.90
470-50	5"	\$4.56
470-60	6"	\$5.32

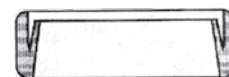

CLOUDBURST TYPE

Part No.	Size	Price
458-40	4"	\$5.94
458-50	5"	\$6.81
458-60	6"	\$8.10



FARMLAND SBS-QRD TYPE "GREEN-DOT" NON-DRAIN

Part No.	Size	Price
472-30	3"	\$2.49
472-40	4"	\$3.88
472-50	5"	\$5.30
472-60	6"	\$7.33
472-80	8"	\$8.73

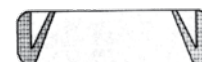

DECOTO TYPE SEAL RING

Part No.	Size	Price
426-40	4"	\$2.41
426-50	5"	\$5.38
426-50DL	5"	\$6.28



* Double Lip Wheel Line Gasket

DIAMOND WATERGATE TYPE

Part No.	Size	Price
484-60	6"	\$4.01
484-80	8"	\$5.95
484-100	10"	\$6.85
484-120	12"	\$11.93



FELCO (FELTON)

DRAIN TYPE		
Part No.	Size	Price
317-20	2"	Call
317-30	3"	\$1.94
317-40	4"	\$2.71

NON-DRAIN TYPE		
Part No.	Size	Price
417-30	3"	\$1.70
417-40	4"	\$2.09
417-50	5"	\$4.71
417-60	6"	\$3.97
417-70	7"	\$5.21
417-80	8"	\$6.24
417-100	10"	\$8.04
417-120	12"	\$13.52

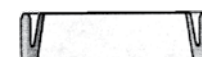

DRAGON TYPE

Part No.	Size	Price
425-30	3"	\$2.87
425-40	4"	\$3.72
425-50	5"	\$4.08
425-60	6"	\$3.97



* Low Pressure

DRESSER TYPE

Part No.	Size	Price
102407 (1)	2" IPS	Call
102408 (1)	2-1/2" IPS	Call
403-30	3" IPS	\$4.27
403-40	4" IPS	\$4.80
403-50	5" IPS	\$5.21
403-60	6" IPS	\$5.90
403-80	8" IPS	\$7.61
403-100	10" IPS	\$8.46
403-120	12" IPS	\$9.45
489-60	6" PIP	\$5.67
489-80	8" PIP	\$7.22
489-100	10" PIP	\$7.61
489-120	12" PIP	\$9.05



FLANGE GASKET 1/16" FULL FACED RED RUBBER

Part No.	Size	Price
CO-APR-606N	2"	Call
CO-APR-607N	2-1/2"	Call
CO-APR-608N	3"	\$1.57
CO-PAR-609N	4"	\$2.02
CO-APR-610N	5"	\$4.48
CO-APR-611N	6"	\$2.99
CO-APR-612N	8"	\$4.48
CO-APR-613N	10"	Call
CO-APR-614N	12"	Call
CO-APR-615N	14"	Call
CO-APR-616N	16"	Call

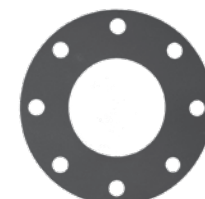

1) D&K CLEARVIEW
2) BARTOS
3) PVC FITTINGS

FRESNO FOR BOLTED COUPLINGS

AC TYPE		
Part No.	Size	Price
F090-120-073	6.57"-6.70"	\$21.12
F090-120-063	6.84"-7.28"	\$21.12
F090-120-072	8.56"-8.75"	\$23.64
F090-120-062	8.99"-9.43"	\$23.64

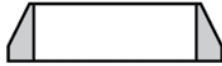

KROY TYPE NON-DRAIN

Part No.	Size	Price
468-60	6"	\$3.97
468-80	8"	\$6.24
468-100	10"	\$8.04
468-120	12"	\$13.52

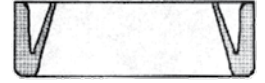

LAKE TYPE - SEE RAIN FOR RENT

LITTLE GIANT PIP

Part No.	Size	Price
205	4"	Call
166	6"	Call
167	8"	Call
168	10"	Call
170	12"	Call
373	14"	Call
335	15"	Call
345	16"	Call

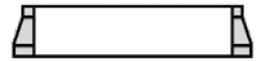

GHEEN TYPE

Part No.	Size	Price
490-20	2"	\$2.30
490-30	3"	\$1.93
490-40	4"	\$2.63
490-50	5"	\$4.47
490-60	6"	\$5.56
490-80	8"	\$7.61
490-100	10"	\$9.93
490-120	12"	\$14.23

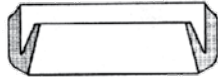

LITTLE GIANT IPS

Part No.	Size	Price
46	4"	Call
206	5"	Call
57	6"	Call
165	8"	Call
169	10"	Call
164	12"	Call
373	14"	Call
345	16"	Call

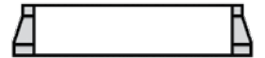

HASTINGS TYPE

Part No.	Size	Price
424-60	6"	\$5.95
424-80	8"	\$7.62
424-100	10"	\$9.36
424-120	12"	\$9.99

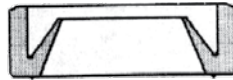

MC DOWELL "SAG" TYPE

Part No.	Size	Price
446-20	2"	\$2.29
446-30	3"	\$2.65
446-40	4"	\$3.42
446-50	5"	\$6.40
446-60	6"	\$7.69
446-70	7"	\$9.33
446-80	8"	\$15.61
446-100	10"	\$15.81

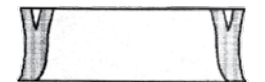

For 1" use Rainmaker 409-15

IRECO - STEELUME

Part No.	Size	Price
*442-15	1-1/2"	\$2.19
442-20	2"	\$2.21
442-30	3"	\$2.09
442-40	4"	\$2.87
442-50	5"	\$3.38
442-52	5-1/4"	\$3.88
442-60	6"	\$4.21
442-80	8"	\$5.30
442-100	10"	\$9.73

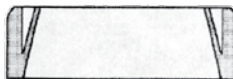

MC DOWELL SPRINGS

Part No.	Size	Price
546-10	1"	\$7.54
546-20	2"	\$7.43
546-30	3"	\$6.38
546-40	4"	\$8.48
546-50	5"	\$11.62
546-60	6"	\$13.61
546-70	7"	\$22.09
546-80	8"	\$24.67



* For Trail Line

GASKETS

MOORE-RANE TYPE

NON-DRAIN		
Part No.	Size	Price
488-20	2"	\$2.41
488-30	3"	\$2.42
488-40	4"	\$3.22
488-50	5"	\$5.12
488-60	6"	\$6.40
488-70	7"	\$8.56
488-80	8"	\$6.71
488-100	10"	\$9.93
488-120	12"	\$16.01

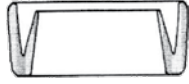

PIERCE IPS COMPRESSION

Part No.	Size	Price
P1600-01	2"	\$4.80
P1601-01	2-1/2"	Call
P1602-01	3"	\$5.76
P1603-01	4"	\$8.40
P1604-01	5"	\$19.20
P1605-01	6"	\$12.00
P1606-01	8"	\$17.52
P1607-01	10"	\$25.20
P1608-01	12"	\$28.80



MOULTON TYPE

Part No.	Size	Price
452-20	2"	\$2.25
452-30	3"	\$2.89
452-40	4"	\$4.08
452-50	5"	\$6.53
452-60	6"	\$7.70
452-70	7"	\$11.62
452-80	8"	\$13.30
452-100	10"	\$16.97

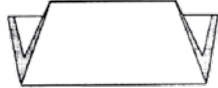

PIERCE PIP COMPRESSION

Part No.	Size	Price
P1609-01	4"	\$7.80
P1610-01	6"	\$10.80
P1611-01	8"	\$15.96
P1612-01	10"	\$22.80
P1613-01	12"	\$26.40
P1614-01	15"	\$47.40
P1615-01	18"	\$51.60

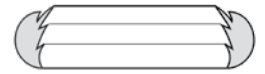

OAKS TYPE

Part No.	Size	Price
450-40	4"	\$4.33
450-50	5"	\$7.93
450-60	6"	\$8.89

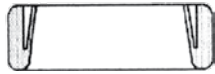

PIERCE FLATBACK

Part No.	Size	Price
P1630-01	2"	\$3.60
P1631-01	3"	\$4.56
P1632-01	4"	\$4.80
P1633-01	5"	\$6.00
P1634-01	6"	\$7.80
P1635-01	8"	\$9.00
P1636-01	10"	\$19.20

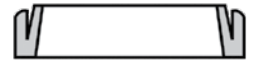

OLIVER TYPE

Part No.	Size	Price
461-20	2"	\$2.37
461-30	3"	\$3.04
461-40	4"	\$3.48
461-50	5"	\$4.09
461-60	6"	\$5.20
461-70	7"	\$6.30

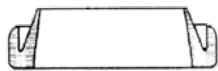

PIERCE ROUNDBACK

Part No.	Size	Price
401-20	2"	\$1.54
401-30	3"	\$1.54
401-40	4"	\$2.41
401-50	5"	\$3.28
401-60	6"	\$3.61
402-66	6-5/8"	\$6.20
401-80	8"	\$4.83
401-100	10"	\$7.51
401-120	12"	\$10.48

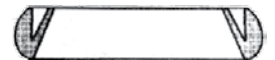

PACIFIC SPEEDLOCK TYPE

NEW STYLE		
Part No.	Size	Price
464-20	2"	\$2.51
464-30	3"	\$3.32
464-40	4"	\$3.64

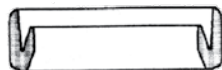

OLD STYLE		
Part No.	Size	Price
462-20	2"	\$2.51
462-30	3"	\$3.42
462-40	4"	\$4.53
462-50	5"	\$5.72
462-60	6"	\$6.51
462-80	8"	\$13.37

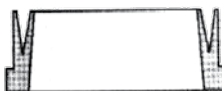

PIERCE TRIPLE LIP

Part No.	Size	Price
402-80	8"	\$8.12
402-100	10"	\$11.34

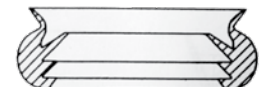

PIERCE IPS WEDGE-TITE®

Part No.	Size	Price
P1640-01	3"	\$3.72
P1640-02	4"	\$3.72
P1640-03	5"	\$6.84
P1640-04	6"	\$4.80
P1640-05	8"	\$6.00
P1640-06	10"	\$7.20
P1640-07	12"	\$20.10

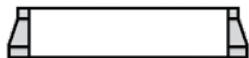

RACE & RACE "LINKLOK" TYPE 1" OUTER LIP

Part No.	Size	Price
415-20	2"	\$2.51
415-30	3"	\$2.94
415-40	4"	\$3.98
415-50	5"	\$5.36
415-60	6"	\$5.92
415-70	7"	\$6.59
415-80	8"	\$9.11

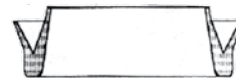

PIERCE OD WEDGE-TITE®

Part No.	Size	Price
P1638-02	4"	\$4.80
P1638-03	5"	Call
P1638-04	6"	\$6.12
P1638-05	8"	\$9.84
P1638-06	10"	\$10.80
P1638-07	12"	\$24.60

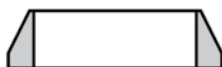

RAIN CONTROL TYPE

Part No.	Size	Price
440-20	2"	\$2.35
440-30	3"	\$3.22
440-40	4"	\$3.98
440-50	5"	\$4.56
440-60	6"	\$5.96
440-80	8"	\$8.34

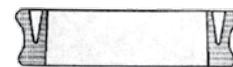

PIERCE PIP WEDGE-TITE®

Part No.	Size	Price
P1639-01	4"	\$6.60
P1639-02	6"	\$7.20
P1639-03	8"	\$8.70
P1639-04	10"	\$11.40
P1639-05	12"	\$36.00
P1639-06	15"	\$104.34



RAIN FOR RENT TYPE

Part No.	Size	Price
457-20	2"	\$1.54
457-30	3"	\$1.71
457-40	4"	\$2.21
457-50	5"	\$4.69
457-60	6"	\$4.33
457-70	7"	\$8.73
457-80	8"	\$5.72
457-100	10"	\$7.32
457-120	12"	\$9.60

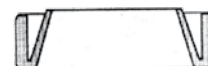

PORT-ALUM TYPE

Part No.	Size	Price
465-20	2"	\$2.85
465-30	3"	\$3.22
465-40	4"	\$4.09



RAINBOW TYPE

Part No.	Size	Price
418-40	4"	\$5.30
418-50	5"	\$6.18
418-60	6"	\$6.75
418-80	8"	\$10.80

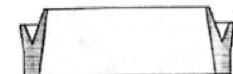

RACE & RACE "DEMOUNTABLE" TYPE 1/4" OUTER LIP

Part No.	Size	Price
414-20	2"	\$2.51
414-30	3"	\$2.82
414-40	4"	\$3.41
414-50	5"	\$4.20
414-60	6"	\$5.21
414-80	8"	\$8.10

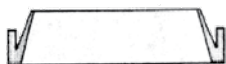

RAINMAKER TYPE

NON-DRAIN		
Part No.	Size	Price
409-15	1-1/2"	\$1.16
409-20	2"	\$2.54
409-30	3"	\$3.02
409-40	4"	\$3.41
409-50	5"	\$4.83
409-60	6"	\$6.55



GASKETS

RAINWAY SQUARE BACK

DRAIN		
Part No.	Size	Price
E-22	2"	\$2.26
E-23	3"	\$2.10
E-24	4"	\$2.88

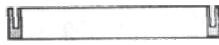

NON-DRAIN		
Part No.	Size	Price
412-20	2"	\$2.10
E-13	3"	\$2.88
E-14	4"	\$1.99
E-15	5"	\$4.00
E-16	6"	\$4.28
E-17	7"	Call
E-18	8"	\$4.24
E-110	10"	Call
E-112	12"	Call

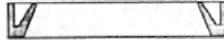

ROUND BACK 3 LIP NON-DRAIN

Part No.	Size	Price
407-30	3"	\$1.54
407-40	4"	\$2.41
407-60	6"	\$3.61
407-80	8"	\$4.83
407-100	10"	\$8.12
407-120	12"	\$11.34



SURE-FLO TYPE SUCTION FILTER SEAL RING

Part No.	Size	Price
473-30	3"	\$2.78
473-40	4"	\$3.71
473-50	5"	\$4.64
473-60	6"	\$5.56



RAVIT TYPE

Part No.	Size	Price
419-20	2"	\$2.42
419-30	3"	\$3.02
419-40	4"	\$2.17
419-50	5"	\$6.16
419-60	6"	\$7.22

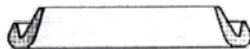

SHUR-RANE TYPE

NEW STYLE - VERY SLOW DRAIN		
Part No.	Size	Price
460-20	2"	\$1.89
460-30	3"	\$2.09
460-40	4"	\$2.89
460-50	5"	\$4.80
460-60	6"	\$5.30
460-80	8"	\$8.79
460-100	10"	\$9.29
460-120	12"	\$12.90

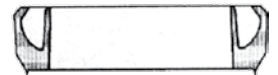

REDI-RAIN TYPE NON-DRAIN

Part No.	Size	Price
*423-12	1-1/4"	\$1.98
423-20	2"	\$1.72
423-30	3"	\$1.83
423-40	4"	\$2.21
423-50	5"	\$2.90
423-60	6"	\$3.88
423-80	8"	\$4.72
423-100	10"	\$6.86



NON-DRAIN - FMC TYPE		
Part No.	Size	Price
454-30	3"	\$2.87
454-40	4"	\$3.98
454-50	5"	\$5.30
454-60	6"	\$5.66
454-80	8"	\$9.75

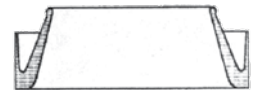

OLD STYLE		
Part No.	Size	Price
455-20	2"	\$2.45
455-30	3"	\$2.85
455-40	4"	\$3.78
455-50	5"	\$5.03
455-60	6"	\$6.34
455-70	7"	\$8.46

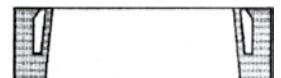

* For Trail Line

RING TYPE DROP IN FLANGE GASKET

Part No.	Size	Price
CPF-3-GR	3"	Call
CPF-4-GR	4"	Call
CPF-5-GR	5"	Call
CPF-6-GR	6"	Call
CPF-8-GR	8"	Call
CPF-10-GR	10"	Call
CPF-12-GR	12"	Call

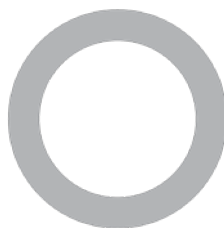

STEELUME TYPE - OLD STYLE REFER TO IRECO FOR NEW STYLE

Part No.	Size	Price
441-30	3"	\$3.48
441-40	4"	\$3.88
441-50	5"	\$5.07
441-60	6"	\$6.86

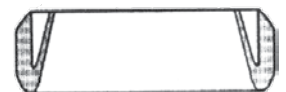

STOUT TYPE MOST COMMON STYLE

Part No.	Size	Price
444-20	2"	\$2.81
444-30	3"	\$2.89
444-40	4"	\$3.78
444-50	5"	\$4.83
444-60	6"	\$5.60



TRAVIS BOLT TITE

IPS		
Part No.	Size	Price
IPSBTG4	4"	\$7.68
IPSBTG5	5"	\$10.13
IPSBTG6	6"	\$12.49
IPSBTG8	8"	\$14.52
IPSBTG10	10"	\$24.86
IPSBTG12	12"	\$29.82



STOUT TYPE VERY OLD STYLE

Part No.	Size	Price
447-20	2"	\$3.97
447-30	3"	\$4.33
447-40	4"	\$4.83
447-50	5"	\$6.65
447-60	6"	\$7.96

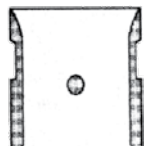

PIP / OD		
Part No.	Size	Price
PIPBTG6	6"	\$12.67
PIPBTG8	8"	\$16.07
PIPBTG10	10"	\$24.86
PIPBTG12	12"	\$29.82
PIPBTG15	15"	\$31.98
PIPBTG18.7	18.7"	\$45.78
PIPBTG20.4	20.4"	\$46.51

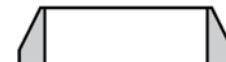

STOUT TYPE SEAL RING

Part No.	Size	Price
445-20	2"	\$1.89
445-30	3"	\$2.51
445-40	4"	\$3.04
445-50	5"	\$4.32
445-60	6"	\$5.03

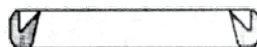

TRAVIS ROUND BACK

Part No.	Size	Price
E-32	2"	\$1.84
E-33	3"	\$1.84
E-34	4"	\$2.88
E-35	5"	\$3.92
E-36	6"	\$4.32
E-37	7"	\$6.52
E-38	8"	\$5.77
E-310	10"	\$9.71
E-312	12"	\$13.57



STOUT TOWLINE SEAL RING

Part No.	Size	Price
478-40	3.5"	\$3.32
478-50	4.5"	\$3.61



TRAVIS SQUARE BACK SEE WESTERN SQUARE BACK

TRI-MATIC TYPE

Part No.	Size	Price
405-15	1.5"	\$1.89
405-70	7"	\$9.48

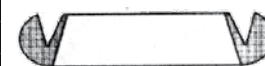

STROLYTE TYPE

Part No.	Size	Price
435-20	2"	\$2.93
435-30	3"	\$3.09
435-40	4"	\$3.77
435-50	5"	\$4.15
435-60	6"	\$5.28



VICTAULIC / GROOVED TYPE

Part No.	Size	Price
105925	2"	Call
105928	2-1/2"	Call
106000	3"	Call
106025	4"	Call
106026	5"	Call
106050	6"	Call
106075	8"	Call
106077	10"	Call
106079	12"	Call

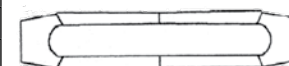

THUNDERBIRD TYPE WHEEL LINE

Part No.	Size	Price
426-40TB	4"	\$5.38



GASKETS, O-RINGS & QUAD RINGS

WADE TYPE NORMAL SLOW DRAIN

Part No.	Size	Price
428-20	2"	\$1.66
428-30	3"	\$1.72
428-40	4"	\$2.71
428-50	5"	\$4.47
428-60	6"	\$5.44
428-70	7"	\$13.59
428-80	8"	\$8.10
428-100	10"	\$11.75

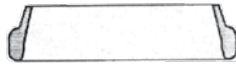

WESTERN SQUARE BACK TYPE

DRAIN		
Part No.	Size	Price
G39	3"	\$3.06
G49	4"	\$5.02

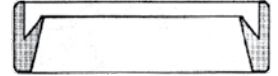

NON-DRAIN		
Part No.	Size	Price
G28	2"	\$2.64
G38	3"	\$2.50
G48	4"	\$3.44
G58	5"	\$4.04
G68	6"	\$5.04
G78	7"	\$10.86
G88	8"	\$6.34
G108	10"	\$11.65
G128	12"	\$13.57

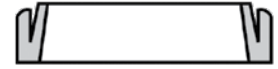

WADE POWERROLL TYPE FAST DRAIN

Part No.	Size	Price
430-40	4"	\$2.41
430-45	4.5"	\$4.16
430-50	5"	\$4.80



WYSS TYPE

Part No.	Size	Price
475-20	2"	\$2.41
475-30	3"	\$2.93
475-40	4"	\$3.48
475-50	5"	\$4.20
475-60	6"	\$5.07



WEBSTER ECONOMIZER TYPE

Part No.	Size	Price
416-20	2"	\$2.63
416-30	3"	\$3.48
416-40	4"	\$4.21
416-50	5"	\$6.16
416-60	6"	\$8.06
416-70	7"	\$11.45
416-80	8"	\$15.15



WYSS SEAL RING

Part No.	Size	Price
476-20	2"	\$2.41
476-30	3"	\$2.78
476-40	4"	\$3.66
476-50	5"	\$4.11
476-60	6"	\$4.92

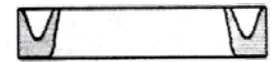

WEBSTER TRIGGER LOCK TYPE

Part No.	Size	Price
453-30	3"	\$4.92
453-40	4"	\$5.79
453-50	5"	\$6.40
453-60	6"	\$7.61
453-70	7"	\$12.07
453-80	8"	\$13.13

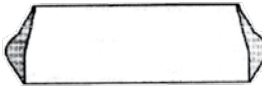

O-RINGS & QUAD RINGS

Part No.	Type	Size ID x WT	Recommended for use with these brands	Price
400-20	"O" Ring	2" x 3/8"	Felton, Port-Alum, Rain Control & Shur-Rane	\$1.50
400-21	"O" Ring	2" x 1/4"	2" Port-Alum	\$1.50
400-30	"O" Ring	3" x 3/8"	Felton, Port-Alum, Rain Control & Shur-Rane	\$1.71
400-31	"O" Ring	3" x 3/8"	Rainmaker L-4	\$1.71
400-37A	"O" Ring	3-7/8" x 3/16"	Moore-Rane Torque Coupler	\$2.17
400-40	"O" Ring	4" x 3/8"	Felton, Port-Alum, Rain Control & Shur-Rane	\$1.99
400-41	"O" Ring	4" x 7/16"	Rainmaker A-4	\$2.17
200463	"O" Ring	4-3/8" x 5/16"	A&M Round	Call
400-43	"O" Ring	4-1/2" x 3/16"	Travis-Western & Pierce	\$1.44
ORG	"O" Ring	4-1/2" x 3/16"	Travis-Western & Pierce	\$1.29
400-44	"O" Ring	4-1/2" x 1/4"	Lake	\$1.71
200470	Square Ring	4-1/2" x 1/4"	A&M Square Type	Call
400-50	"O" Ring	5" x 3/8"	Felton, Port-Alum, Rain Control & Shur-Rane	\$2.54
400-51	"O" Ring	5" x 3/8"	Rainmaker	\$2.54
400-54A	"O" Ring	5-3/8" x 1/4"	Shur-Roll	\$4.25
400-60	"O" Ring	6" x 3/8"	Felton, Port-Alum, Rain Control & Shur-Rane	\$2.89
404-45	Quad Ring	4-1/2" x 1/4"	Lake	Call
200426	Quad Ring	4-1/2" x 1/4"	Trunnell	Call

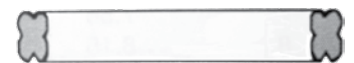
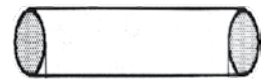

GASKET CROSS REFERENCE

A & M OLD STYLE ROUND BACK	=	PIERCE TYPE
ALUMAX TYPE	=	A & M TYPE
ALUME TYPE	=	STOUT TYPE
AMES QCL TYPE	=	PIERCE TYPE
ATLAS TYPE	=	PIERCE TYPE
AULT TYPE	=	RAINMAKER TYPE (EXCEPT 3")
BEN GAR FULL TYPE	=	A & M TYPE
BOSS TYPE	=	A & M TYPE
BROWN TYPE	=	A & M TYPE
CHAMPION TYPE 3"	=	MOORE RANE/GHEEN TYPE
CROWN AM TYPE	=	RAIN FOR RENT TYPE
DAZOC TYPE	=	MOORE-RANE TYPE, COZAD TYPE, GHEEN TYPE
DECOTO TYPE	=	PIERCE TYPE
DUAL-LOCK TYPE	=	RAINWAY TYPE
FELCO TYPE	=	FELTON TYPE, KROY TYPE
FLEX-O-SEAL TYPE	=	CHICAGO TYPE
FREMONT GATE	=	NUSLIDE GATE
GHEEN TYPE	=	LINDSAY TYPE, COZAD TYPE, MIDWEST BAND & HOOK TYPE
HINESMAN TYPE	=	A & M TYPE
HOMARK TYPE	=	PIERCE TYPE
IRECO ALLUME TYPE	=	STOUT TYPE
KROY TYPE	=	FELTON TYPE
LAKE TYPE	=	WOSCO TYPE, IRECO TYPE, RAIN FOR RENT TYPE
LAKE TORQUE TYPE	=	QUAD RING TYPE
MATTHESON TYPE	=	CHAMPION TYPE
MILLER POSTON TYPE	=	A & M TYPE
MIDWEST TYPE	=	WOSCO TYPE , RAIN FOR RENT TYPE
MOORE RAIN TYPE	=	GHEEN TYPE
PIERCE ROUND BACK TYPE	=	TRAVIS ROUND BACK TYPE
PIERCE FLAT BACK TYPE	=	WESTERN SQUARE BACK TYPE
PORT-ALUME TYPE	=	SHUR RANE TYPE, CHAMPION TYPE
RAIN FOR RENT TYPE	=	IRECO TYPE, WOSCO TYPE, LAKE TYPE, CROWN AM TYPE
RAIN CONTROL TYPE	=	HARDIE TYPE
RAINWAY ROUND TYPE	=	PIERCE TYPE
RAINWAY SQUARE TYPE	=	A & M TYPE
READY RAINE RAIN	=	RAINWAY TYPE
REDI-RAIN TYPE	=	A & M TYPE
ROUND BACK TYPE	=	PIERCE TYPE, TRAVIS TYPE
ROLL-RAIN TYPE	=	SHUR-RANE OLD STYLE TYPE
SHUR-RANE (OLD STYLE) TYPE	=	ROLL-RANE, VERMEER
STOUT TYPE	=	ALLUME TYPE, T-L & IRECO SPEED ROLL TYPE
TELEDYNE TYPE	=	A & M TYPE
TEX FLO-ROUND BACK TYPE	=	PIERCE TYPE (EXCEPT 2 & 3)
TEX FLO-SQUARE BACK	=	HASTINGS
TRAVIS ROUND BACK TYPE	=	PIERCE ROUND BACK TYPE
TRAVIS SQUARE BACK TYPE	=	PIERCE FLAT BACK TYPE, WESTERN SQUARE BACK TYPE
VERMEER TYPE	=	SHUR RANE OLD STYLE TYPE
WOSCO TYPE	=	RAIN FOR RENT TYPE, MIDWEST TYPE, LAKE TYPE
WYSS TYPE	=	CROWN TYPE, MONTGOMERY WARD TYPE, STOUTBILT ALUM. TYPE
WYSS SEAL RING TYPE	=	OLD STYLE STOUT TYPE

Intro 1 - Pivot 2 - Valves 3 - Surface 4 - IPS Epoxy / Galv. 5 - Suction Fittings 6 - PVC Fittings 7 - Sprinklers 8 - Malleable 9 - Hose 10 - Injectors / Filters 11 - Low Volume Formulas / TC

travis 52" Z-pipe

52" Z-PIPE / EPOXY / NO OUTLETS (FLANGE END X IPS BELL)

Part No.	Flange End	IPS Bell	Air	Gauge Port	Price
TR-IPS-Z-4-FLG-NO	4"	4"	-	-	\$546.95
TR-IPS-Z-6-FLG-NO	6"	6"	-	-	\$576.24
TR-IPS-Z-8-FLG-NO	8"	8"	-	-	\$684.28
TR-IPS-Z-10-FLG-NO	10"	10"	-	-	\$987.68
TR-IPS-Z-12-FLG-NO	12"	12"	-	-	\$1,147.36

52" Z-PIPE / EPOXY / WITH OUTLETS (FLANGE END X IPS BELL)

Part No.	Flange End	IPS Bell	Air	Gauge Port	Price
TR-IPS-Z-4-FLG	4"	4"	3"	3/4"	\$579.25
TR-IPS-Z-6-FLG	6"	6"	3"	3/4"	\$619.60
TR-IPS-Z-8-FLG	8"	8"	3"	3/4"	\$684.28
TR-IPS-Z-10-FLG	10"	10"	3"	3/4"	\$977.04
TR-IPS-Z-12-FLG	12"	12"	3"	3/4"	\$1,128.92

52" Z-PIPE / GALV. / NO OUTLETS (FLANGE END X IPS BELL)

Part No.	Flange End	IPS Bell	Air	Gauge Port	Price
TR-IPS-Z-4-FLG-NO-G	4"	4"	-	-	\$579.25
TR-IPS-Z-6-FLG-NO-G	6"	6"	-	-	\$619.60
TR-IPS-Z-8-FLG-NO-G	8"	8"	-	-	\$684.28
TR-IPS-Z-10-FLG-NO-G	10"	10"	-	-	\$987.68
TR-IPS-Z-12-FLG-NO-G	12"	12"	-	-	\$1,147.36

52" Z-PIPE / GALV. / WITH OUTLETS (FLANGE END X IPS BELL)

Part No.	Flange End	IPS Bell	Air	Gauge Port	Price
TR-IPS-Z-4-FLG-G	4"	4"	3"	3/4"	\$579.25
TR-IPS-Z-6-FLG-G	6"	6"	3"	3/4"	\$619.60
TR-IPS-Z-8-FLG-G	8"	8"	3"	3/4"	\$735.79
TR-IPS-Z-10-FLG-G	10"	10"	3"	3/4"	\$977.04
TR-IPS-Z-12-FLG-G	12"	12"	3"	3/4"	\$1,128.92



Intro 1 - Pivot 2 - Valves 3 - Surface 4 - IPS Epoxy / Galv 5 - Suction Fittings 6 - PVC Fittings 7 - Sprinklers 8 - Malleable 9 - Hose 10 - Injectors / Filters 11 - Low Volume Formulas / TC

**PIERCE EPOXY
IPS TEE RISER
(FEMALE X FEMALE)**

Size	Part No.	Price
4" x 4" x 4" x 36"	P1220-05	\$266.40
4" x 4" x 4" x 42"	P1220-06	\$271.20
6" x 6" x 4" x 36"	P1223-05	\$338.40
6" x 6" x 4" x 42"	P1223-06	\$345.60
8" x 8" x 4" x 36"	P1226-05	\$398.40
8" x 8" x 4" x 42"	P1226-06	\$411.60
6" x 6" x 6" x 36"	P1224-05	\$393.60
6" x 6" x 6" x 42"	P1224-06	\$405.60
8" x 8" x 6" x 36"	P1227-05	\$463.20
8" x 8" x 6" x 42"	P1227-06	\$482.40
10" x 10" x 6" x 36"	P1230-05	\$568.80
10" x 10" x 6" x 42"	P1230-06	\$577.20
10" x 10" x 8" x 36"	P1231-05	\$691.20
10" x 10" x 8" x 42"	P1231-06	\$732.00



**FRESNO / PIERCE GALVANIZED
IPS INLINE RISER
(FEMALE X FEMALE)**

Part No.	Size	Price
FV-P1220-25	4" x 4" x 4" x 36"	\$222.50
FV-P1220-26	4" x 4" x 4" x 42"	\$234.22
FV-P1223-25	6" x 6" x 4" x 36"	\$286.97
FV-P1223-26	6" x 6" x 4" x 42"	\$293.93
FV-P1226-25	8" x 8" x 4" x 36"	\$362.24
FV-P1226-26	8" x 8" x 4" x 42"	\$375.49
FV-P1224-25	6" x 6" x 6" x 36"	\$350.22
FV-P1224-26	6" x 6" x 6" x 42"	\$374.35
FV-P1227-25	8" x 8" x 6" x 36"	\$436.43
FV-P1227-26	8" x 8" x 6" x 42"	\$457.20
FV-P1230-25	10" x 10" x 6" x 36"	\$493.93
FV-P1230-26	10" x 10" x 6" x 42"	\$538.40
FV-P1231-25	10" x 10" x 8" x 36"	\$799.74
FV-P1231-26	10" x 10" x 8" x 42"	\$828.04

**PIERCE EPOXY
IPS CAP RISERS
(FEM X CAP)**

Size	Part No.	Price
4" x 4" x 36"	P1252-05	\$268.80
4" x 4" x 42"	P1252-06	\$276.00
6" x 4" x 36"	P1254-05	\$300.00
6" x 4" x 42"	P1254-06	\$304.80
8" x 4" x 36"	P1256-05	\$338.40
8" x 4" x 42"	P1256-06	\$376.80
6" x 6" x 36"	P1255-05	\$396.00
6" x 6" x 42"	P1255-06	\$408.00
8" x 6" x 36"	P1257-05	\$456.00
8" x 6" x 42"	P1257-06	\$475.20
10" x 6" x 36"	P1260-05	\$477.60
10" x 6" x 42"	P1260-06	\$504.00
10" x 8" x 36"	P1261-05	\$672.00
10" x 8" x 42"	P1261-06	\$715.20
	P1264-06	\$988.80



**FRESNO / PIERCE GALVANIZED
IPS CAP RISER
(FEM X CAP)**

Part No.	Size	Price
FV-P1252-25	4" x 4" x 36"	\$223.74
FV-P1252-26	4" x 4" x 42"	\$232.96
FV-P1254-25	6" x 4" x 36"	\$265.28
FV-P1254-26	6" x 4" x 42"	\$271.99
FV-P1256-25	8" x 4" x 36"	\$317.38
FV-P1256-26	8" x 4" x 42"	\$326.51
FV-P1255-25	6" x 6" x 36"	\$331.07
FV-P1255-26	6" x 6" x 42"	\$347.02
FV-P1257-25	8" x 6" x 36"	\$403.90
FV-P1257-26	8" x 6" x 42"	\$422.74
FV-P1260-25	10" x 6" x 36"	\$470.83
FV-P1260-26	10" x 6" x 42"	\$486.80
FV-P1261-05	10" x 8" x 36"	\$736.68
FV-P1261-06	10" x 8" x 42"	\$764.94

**FRESNO / PIERCE EPOXY
IPS INLINE RISER
(FEMALE X FEM W/ 2" MIPT SWEEP)**

Part No.	Size	Price
FV-P3571-03	4" x 4" x 4" x 36" x 2"	\$324.97
FV-P3571-04	4" x 4" x 4" x 42" x 2"	\$331.87
FV-P3398-04	6" x 6" x 4" x 36" x 2"	\$409.40
FV-P3398-05	6" x 6" x 4" x 42" x 2"	\$416.29
FV-P3768-04	8" x 8" x 4" x 36" x 2"	\$470.88
FV-P3768-05	8" x 8" x 4" x 42" x 2"	\$495.52
FV-P3348-04	6" x 6" x 6" x 36" x 2"	\$469.91
FV-P3348-05	6" x 6" x 6" x 42" x 2"	\$469.62
FV-P3349-04	8" x 8" x 6" x 36" x 2"	\$539.27
FV-P3349-05	8" x 8" x 6" x 42" x 2"	\$569.84
FV-P3695-04	10" x 10" x 6" x 36" x 2"	\$664.09
FV-P3695-05	10" x 10" x 6" x 42" x 2"	\$683.28
FV-P3654-05	10" x 10" x 8" x 36" x 2"	\$912.02
FV-P3654-06	10" x 10" x 8" x 42" x 2"	-



**FRESNO / PIERCE GALVANIZED
IPS INLINE RISER
(FEM X FEM W/ 2" MIPT SWEEP)**

Part No.	Size	Price
FV-P3571-23	4" x 4" x 4" x 36" x 2"	\$302.39
FV-P3571-24	4" x 4" x 4" x 42" x 2"	\$294.04
FV-P3398-24	6" x 6" x 4" x 36" x 2"	\$347.70
FV-P3398-25	6" x 6" x 4" x 42" x 2"	\$359.48
FV-P3768-24	8" x 8" x 4" x 36" x 2"	\$424.55
FV-P3768-25	8" x 8" x 4" x 42" x 2"	\$434.62
FV-P3348-24	6" x 6" x 6" x 36" x 2"	\$420.23
FV-P3348-25	6" x 6" x 6" x 42" x 2"	\$435.29
FV-P3349-24	8" x 8" x 6" x 36" x 2"	\$489.74
FV-P3349-25	8" x 8" x 6" x 42" x 2"	\$504.83
FV-P3695-24	10" x 10" x 6" x 36" x 2"	\$600.36
FV-P3695-25	10" x 10" x 6" x 42" x 2"	\$675.84
FV-P3654-25	10" x 10" x 8" x 36" x 2"	\$952.36
FV-P3654-26	10" x 10" x 8" x 42" x 2"	\$1,016.05

**FRESNO / PIERCE EPOXY
IPS CAP RISER
(FEMALE X CAP W/ 2" MIPT SWEEP)**

Part No.	Size	Price
FV-P3345-04	4" x 4" x 36" x 2"	\$331.91
FV-P3345-05	4" x 4" x 42" x 2"	\$334.96
FV-P3395-04	6" x 4" x 36" x 2"	\$381.94
FV-P3395-05	6" x 4" x 42" x 2"	\$398.08
FV-P3456-04	8" x 4" x 36" x 2"	\$441.49
FV-P3456-05	8" x 4" x 42" x 2"	\$453.41
FV-P3341-05	6" x 6" x 36" x 2"	\$452.24
FV-P3341-06	6" x 6" x 42" x 2"	\$471.91
FV-P3340-05	8" x 6" x 36" x 2"	\$533.84
FV-P3340-06	8" x 6" x 42" x 2"	\$557.66
FV-P3443-05	10" x 6" x 36" x 2"	\$563.09
FV-P3443-06	10" x 8" x 42" x 2"	\$571.76
FV-P3648-05	10" x 8" x 36" x 2"	\$859.63
FV-P3648-06	10" x 8" x 42" x 2"	\$905.87



**FRESNO / PIERCE GALVANIZED
IPS CAP RISER
(FEMALE X CAP W/ 2" MIPT SWEEP)**

Part No.	Size	Price
FV-P3345-24	4" x 4" x 36" x 2"	\$276.74
FV-P3345-25	4" x 4" x 42" x 2"	\$283.99
FV-P3395-24	6" x 4" x 36" x 2"	\$329.70
FV-P3395-25	6" x 4" x 42" x 2"	\$34.54
FV-P0098-73	8" x 4" x 36" x 2"	\$383.99
FV-P3456-25	8" x 4" x 42" x 2"	\$397.85
FV-P3341-25	6" x 6" x 36" x 2"	\$379.46
FV-P3341-26	6" x 6" x 42" x 2"	\$398.66
FV-P3340-25	8" x 6" x 36" x 2"	\$449.68
FV-P3340-26	8" x 6" x 42" x 2"	\$464.69
FV-P3443-25	10" x 6" x 36" x 2"	\$537.62
FV-P3443-26	10" x 8" x 42" x 2"	\$553.09
FV-P3648-35	10" x 8" x 36" x 2"	\$883.26
FV-P3648-36	10" x 8" x 42" x 2"	\$915.67

Check Price

**FRESNO / PIERCE EPOXY
IPS INLINE RISER
(FEMALE X FEMALE - FLANGE ON TOP)**

Part No.	Size	Price
FV-P3310-05	4" x 4" x 4" x 36"	\$260.35
FV-P3310-06	4" x 4" x 4" x 42"	\$313.49
FV-P3314-05	6" x 6" x 4" x 36"	\$315.32
FV-P3314-06	6" x 6" x 4" x 42"	\$317.66
FV-P3315-05	8" x 8" x 4" x 36"	\$364.85
FV-P3315-06	8" x 8" x 4" x 42"	\$388.80
FV-P3311-05	6" x 6" x 6" x 36"	\$346.31
FV-P3311-06	6" x 6" x 6" x 42"	\$354.98
FV-P3316-05	8" x 8" x 6" x 36"	\$408.96
FV-P3316-06	8" x 8" x 6" x 42"	\$439.25
FV-P3317-05	10" x 10" x 6" x 36"	\$477.23
FV-P3317-06	10" x 10" x 6" x 42"	\$507.52
FV-P3318-05	10" x 10" x 8" x 36"	\$528.83
FV-P3318-06	10" x 10" x 8" x 42"	\$620.83



**FRESNO / PIERCE GALVANIZED
IPS INLINE RISER
(FEMALE X FEMALE - FLANGE ON TOP)**

Part No.	Size	Price
FV-P3310-25	4X4X4X36"	\$216.95
FV-P3310-26	4X4X4X42"	\$250.01
FV-P3314-25	6X6X4X36"	\$280.08
FV-P3314-26	6X6X4X42"	\$286.92
FV-P3315-25	8X8X4X36"	\$345.12
FV-P3315-26	8X8X4X42"	\$353.32
FV-P3311-25	6X6X6X36"	\$322.69
FV-P3311-26	6X6X6X42"	\$359.50
FV-P3316-25	8X8X6X36"	\$403.00
FV-P3316-26	8X8X6X42"	\$418.20
FV-P3317-25	10x10x6x36"	\$491.84
FV-P3317-26	10x10x6x42"	\$507.06
FV-P3318-25	10x10x8x36"	\$637.19
FV-P3318-26	10X10X8X42"	\$664.66

**FRESNO / PIERCE EPOXY
IPS CAP RISER
(FEMALE X CAP - FLANGE ON TOP)**

Part No.	Size	Price
FV-P3319-05	4" x 4" x 4" x 36"	\$248.06
FV-P3319-06	4" x 4" x 4" x 42"	\$250.42
FV-P3312-05	6" x 6" x 4" x 36"	\$292.91
FV-P3312-06	6" x 6" x 4" x 42"	\$295.26
FV-P3326-05	8" x 8" x 4" x 36"	\$337.70
FV-P3326-06	8" x 8" x 4" x 42"	\$362.27
FV-P3313-05	6" x 6" x 6" x 36"	\$328.12
FV-P3313-06	6" x 6" x 6" x 42"	\$336.79
FV-P3327-05	8" x 8" x 6" x 36"	\$381.82
FV-P3327-06	8" x 8" x 6" x 42"	\$412.04
FV-P3328-05	10" x 10" x 6" x 36"	\$427.75
FV-P3328-06	10" x 10" x 6" x 42"	\$458.03
FV-P3329-05	10" x 10" x 8" x 36"	\$536.21
FV-P3329-06	10" x 10" x 8" x 42"	\$574.94



**FRESNO / PIERCE GALVANIZED
IPS CAP RISER
(FEMALE X CAP - FLANGE ON TOP)**

Part No.	Size	Price
FV-P3319-25	4X4X36"	\$198.37
FV-P3319-26	4X4X42"	\$205.00
FV-P3312-25	6X4X36"	\$250.49
FV-P3312-26	6X4X42"	\$257.34
FV-P3326-25	8X4X36"	\$307.50
FV-P3326-26	8X4X42"	\$314.16
FV-P3313-25	6X6X36"	\$297.31
FV-P3313-26	6X6X42"	\$312.67
FV-P3327-25	8X6X36"	\$363.96
FV-P3327-26	8X6X42"	\$379.13
FV-P3328-25	10x6x36"	\$425.70
FV-P3328-26	10x6x42"	\$440.87
FV-P3329-25	10x8x36"	\$582.43
FV-P3329-26	10X8X42"	\$610.93

**FRESNO / PIERCE EPOXY
IPS INLINE RISER
(FEM X FEM W/ 2" MIPT SWEEP - FLANGE ON TOP)**

Part No.	Size	Price
FV-P3320-05	4" x 4" x 4" x 36" x 2"	\$304.69
FV-P3320-06	4" x 4" x 4" x 42" x 2"	\$327.14
FV-P3325-05	6" x 6" x 4" x 36" x 2"	\$365.77
FV-P3325-06	6" x 6" x 4" x 42" x 2"	\$370.93
FV-P3330-05	8" x 8" x 4" x 36" x 2"	\$418.14
FV-P3330-06	8" x 8" x 4" x 42" x 2"	\$445.63
FV-P3321-05	6" x 6" x 6" x 36" x 2"	\$401.53
FV-P3321-06	6" x 6" x 6" x 42" x 2"	\$410.14
FV-P3331-05	8" x 8" x 6" x 36" x 2"	\$467.46
FV-P3331-06	8" x 8" x 6" x 42" x 2"	\$498.04
FV-P3332-05	10" x 10" x 6" x 36" x 2"	\$535.33
FV-P3332-06	10" x 10" x 6" x 42" x 2"	\$566.27
FV-P3334-05	10" x 10" x 8" x 36" x 2"	\$672.41
FV-P3334-06	10" x 10" x 8" x 42" x 2"	\$711.13



**FRESNO / PIERCE GALVANIZED
IPS INLINE RISER
(FEM X FEM W/ 2" MIPT SWEEP - FLANGE ON TOP)**

Part No.	Size	Price
FV-P3320-25	4X4X4X36X2"	\$268.63
FV-P3320-26	4X4X4X42X2"	\$293.04
FV-P3325-25	6X6X4X36X2"	\$334.44
FV-P3325-26	6X6X4X42X2"	\$344.14
FV-P3330-25	8X8X4X36X2"	\$407.17
FV-P3330-26	8X8X4X42X2"	\$417.05
FV-P3321-25	6X6X6X36X2"	\$381.94
FV-P3321-26	6X6X6X42X2"	\$390.16
FV-P3331-25	8X8X6X36X2"	\$470.03
FV-P3331-26	8X8X6X42X2"	\$485.52
FV-P3332-25	10x10x6x36X2"	\$560.35
FV-P3332-26	10x10x6x42X2"	\$576.07
FV-P3334-25	10x10x8x36X2"	\$740.56
FV-P3334-26	10X10X8X42X2"	\$768.96

**FRESNO / PIERCE EPOXY
IPS CAP RISER
(FEM X CAP W/ 2" MIPT SWEEP - FLANGE ON TOP)**

Part No.	Size	Price
FV-P3338-05	4" x 4" x 36" x 2"	\$301.36
FV-P3338-06	4" x 4" x 42" x 2"	\$306.52
FV-P3322-05	6" x 4" x 36" x 2"	\$343.36
FV-P3322-06	6" x 4" x 42" x 2"	\$348.53
FV-P3339-05	8" x 4" x 36" x 2"	\$391.00
FV-P3339-06	8" x 4" x 42" x 2"	\$418.50
FV-P3323-05	6" x 6" x 36" x 2"	\$383.34
FV-P3323-06	6" x 6" x 42" x 2"	\$391.96
FV-P3343-05	8" x 6" x 36" x 2"	\$439.94
FV-P3343-06	8" x 6" x 42" x 2"	\$470.89
FV-P3344-05	10" x 6" x 36" x 2"	\$485.84
FV-P3346-06	10" x 6" x 42" x 2"	\$516.79
FV-P3346-05	10" x 8" x 36" x 2"	\$662.92
FV-P3346-06	10" x 8" x 42" x 2"	\$661.92



**FRESNO / PIERCE GALVANIZED
IPS CAP RISER
(FEM X CAP W/ 2" MIPT SWEEP - FLANGE ON TOP)**

Part No.	Size	Price
FV-P3338-25	4X4X36X2"	\$256.73
FV-P3338-26	4X4X42X2"	\$266.52
FV-P3322-25	6X4X36X2"	\$304.85
FV-P3322-26	6X4X42X2"	\$314.58
FV-P3339-25	8X4X36X2"	\$367.26
FV-P3339-26	8X4X42X2"	\$377.09
FV-P3323-25	6X6X36X2"	\$356.56
FV-P3323-26	6X6X42X2"	\$371.92
FV-P3343-25	8X6X36X2"	\$430.04
FV-P3343-26	8X6X42X2"	\$445.57
FV-P3344-25	10x6x36X2"	\$493.02
FV-P3344-26	10x6x42X2"	\$508.78
FV-P3346-25	10x8x36X2"	\$673.27
FV-P3346-26	10X8X42X2"	\$701.83



**PIERCE
IPS SERVICE TEE WITH FIPT OUTLET**

Size	Part No.	Price
2" x 1"	P1354-01	\$105.60
2" x 1-1/4"	P1354-02	\$109.20
2" x 1-1/2"	P1355-01	\$120.00
2" x 2"	P1355-02	\$146.40
2-1/2" x 1"	P1356-01	\$84.00
2-1/2" x 1-1/4"	P1356-02	\$88.80
2-1/2" x 1-1/2"	P1356-03	\$91.20
2-1/2" x 2"	P1357-01	\$93.60
2-1/2" x 2-1/2"	P1357-02	\$98.40
3" x 1"	P1358-01	\$88.80
3" x 1-1/4"	P1358-02	\$94.80
3" x 1-1/2"	P1358-03	\$96.00
3" x 2"	P1359-01	\$103.20
3" x 2-1/2"	P1359-02	\$110.40
3" x 3"	P1359-03	\$117.60
4" x 1"	P1360-01	\$96.00
4" x 1-1/4"	P1360-02	\$100.80
4" x 1-1/2"	P1360-03	\$102.00
4" x 2"	P1360-04	\$105.60
4" x 2-1/2"	P1361-01	\$117.60
4" x 3"	P1361-02	\$132.00
4" x 4"	P1361-03	\$157.20
6" x 1"	P1364-01	\$105.60
6" x 1-1/4"	P1364-02	\$112.80
6" x 1-1/2"	P1364-03	\$117.60
6" x 2"	P1364-04	\$120.00
6" x 2-1/2"	P1365-01	\$148.80
6" x 3"	P1365-02	\$177.60
6" x 4"	P1365-03	\$189.60
6" x 6"	P1365-05	\$232.80
8" x 1-1/2"	P1367-02	\$170.40
8" x 2"	P1367-03	\$180.00
8" x 3"	P1368-02	\$235.20
8" x 4"	P1368-03	\$266.40
10" x 1-1/2"	P1370-02	\$225.60
10" x 2"	P1370-03	\$248.40
10" x 2-1/2"	P1371-01	\$253.20
10" x 3"	P1372-01	\$270.00
10" x 4"	P1372-02	\$332.40
12" x 1-1/2"	P1374-02	\$235.20
12" x 2"	P1372-03	\$273.60
12" x 2-1/2"	P1375-01	\$255.60
12" x 3"	P1375-02	\$268.80
12" x 4"	P1376-01	\$357.60



**TRAVIS
IPS SERVICE TEE WITH FIPT OUTLET**

Size	Part No.	Price
4" x 3"	IPS-43FT-FF	\$181.30
5" x 3"	IPS-53FT-FF	\$199.75
6" x 3"	IPS-63FT-FF	\$201.11
8" x 3"	IPS-83FT-FF	\$266.34
10" x 3"	IPS-103FT-FF	\$294.02
12" x 3"	IPS-123FT-FF	\$353.38
4" x 4"	IPS-44FT-FF	\$193.07
5" x 4"	IPS-54FT-FF	\$211.55
6" x 4"	IPS-64FT-FF	\$212.89
8" x 4"	IPS-84FT-FF	\$278.12
10" x 4"	IPS-104FT-FF	\$301.24
12" x 4"	IPS-124FT-FF	\$365.16
Note: 6" and above available with 6" thread. Add price to the list price of appropriate 4" FIPT outlet.		\$52.33

**TRAVIS
IPS SERVICE TEE WITH MIPT OUTLET**

Size	Part No.	Price
4" x 3"	IPS-43MT-FF	\$179.90
5" x 3"	IPS-53MT-FF	\$193.13
6" x 3"	IPS-63MT-FF	\$194.47
8" x 3"	IPS-83MT-FF	\$259.72
10" x 3"	IPS-103MT-FF	\$287.39
12" x 3"	IPS-123MT-FF	\$346.75
4" x 4"	IPS-44MT-FF	\$183.48
5" x 4"	IPS-54MT-FF	\$201.95
6" x 4"	IPS-64MT-FF	\$203.32
8" x 4"	IPS-84MT-FF	\$268.52
10" x 4"	IPS-104MT-FF	\$296.24
12" x 4"	IPS-124MT-FF	\$355.60
Note: 6" and above available with 6" thread. Add price to the list price of appropriate 4" MIPT outlet.		\$40.09

IPS EPOXY FITTINGS

PIERCE ELBOW OPTION FOR TEE & CAP RISER

Size	Part No.	Price
2" MIPT SWEEP	P2MIPT-SE	Call
3" MIPT SWEEP	P3MIPT-SE	Call
4" MIPT SWEEP	P4MIPT-SE	Call
2" FIPT SWEEP	P2FIPT-SE	Call
3" FIPT SWEEP	P3FIPT-SE	Call
4" FIPT SWEEP	P4FIPT-SE	Call



TRAVIS ELBOW OPTION FOR TEE & CAP RISER

Size	Part No.	Price
2" MIPT SWEEP	TR-B-2-MPT	\$100.97
3" MIPT SWEEP	TR-B-3-MPT	Call
4" MIPT SWEEP	TR-B-4-MPT	Call
2" FIPT SWEEP	TR-B-2-FPT	Call
3" FIPT SWEEP	TR-B-3-FPT	Call
4" FIPT SWEEP	TR-B-4-FPT	Call

PIERCE IPS REDUCER FEMALE X FEMALE

IPS Bell	IPS Bell	Part No.	Price
2-1/2"	2"	P1527-01	\$98.40
3"	2"	P1527-02	\$98.40
3"	2-1/2"	P1527-03	\$86.40
4"	2"	P1527-04	\$109.20
4"	2-1/2"	P1527-05	\$93.60
4"	3"	P1527-06	\$97.20
6"	2"	P1528-04	\$136.80
6"	2-1/2"	P1528-05	\$128.40
6"	3"	P1528-06	\$129.60
6"	4"	P1527-08	\$120.00
8"	4"	P1528-07	\$168.00
8"	6"	P1527-10	\$148.80
10"	4"	P1529-04	\$240.00
10"	6"	P1528-09	\$217.20
10"	8"	P1527-11	\$196.80
12"	6"	P1529-06	\$302.40
12"	8"	P1528-10	\$276.00
12"	10"	P1527-12	\$261.60



TRAVIS IPS REDUCER FEMALE X FEMALE

Size	Part No.	Price
5" x 4"	IPS-R54	\$139.58
6" x 3"	IPS-R63	Call
6" x 4"	IPS-R64	\$141.89
6" x 5"	IPS-R65	\$159.30
8" x 6"	IPS-R86	\$184.68
10" x 6"	IPS-R106	\$260.75
10" x 8"	IPS-R108	\$254.60
12" x 8"	IPS-R128	\$329.63
12" x 10"	IPS-R1210	\$308.46

PIERCE IPS REDUCER MALE X FEMALE

IPS Male	IPS Bell	Part No.	Price
2-1/2"	2"	P1532-01	\$93.60
3"	2-1/2"	P1532-02	\$96.00
3"	2"	P1532-03	\$86.40
4"	2"	P1532-04	\$103.20
4"	2-1/2"	P1532-05	\$91.20
4"	3"	P1532-06	\$91.20
6"	2"	P1533-04	\$139.20
6"	2-1/2"	P1533-05	\$127.20
6"	3"	P1533-06	\$132.00
6"	4"	P1532-08	\$127.20
8"	3"	P1534-03	\$163.20
8"	4"	P1533-07	\$180.00
8"	6"	P1532-10	\$147.60
10"	4"	P1534-04	\$223.20
10"	6"	P1533-09	\$225.60
10"	8"	P1532-11	\$182.40
12"	6"	P1534-06	\$285.60
12"	8"	P1533-10	\$264.00
12"	10"	P1532-12	\$242.40



TRAVIS IPS REDUCER MALE X FEMALE

Size	Part No.	Price
5" x 4"	IPS-R54MXF	\$139.58
6" x 3"	IPS-R63MXF	Call
6" x 4"	IPS-R64MXF	\$141.89
6" x 5"	IPS-R65MXF	\$159.30
8" x 6"	IPS-R86MXF	\$184.68
10" x 6"	IPS-R106MXF	\$260.75
10" x 8"	IPS-R108MXF	\$254.60
12" x 8"	IPS-R128MXF	\$329.63
12" x 10"	IPS-R1210MXF	\$308.46

IPS EPOXY FITTINGS

PIERCE IPS END CAP

Size	Part No.	Price
2"	P1588-01	\$54.00
2-1/2"	P1588-02	\$54.00
3"	P1588-03	\$57.60
4"	P1588-04	\$62.40
6"	P1588-06	\$79.20
8"	P1588-07	\$124.80
10"	P1588-08	\$160.80
12"	P1588-09	\$182.40

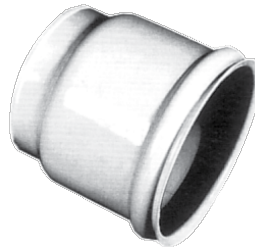

TRAVIS IPS END CAP

Size	Part No.	Price
4"	IPS-FEP-4	\$77.87
5"	IPS-FEP-5	\$99.83
6"	IPS-FEP-6	\$103.32
8"	IPS-FEP-8	\$126.62
10"	IPS-FEP-10	\$167.44
12"	IPS-FEP-12	\$234.17

PIERCE IPS END CAP WITH FIPT OUTLET

Size	Part No.	Price
2" x 1-1/2"	P1424-01	\$88.80
2"-1/2" x 1-1/2"	P1425-03	\$88.80
3" x 1-1/2"	P1427-03	\$88.80
4" x 1-1/2"	P1429-03	\$91.20
4" x 2"	P1429-04	\$102.00



TRAVIS IPS END CAP WITH FIPT OUTLET

Size	Part No.	Price
4" x 1-1/2"	IPS-FEP-4-150	Call
4" x 2"	IPS-FEP-4-200	Call
6" x 1-1/2"	IPS-FEP-6-150	Call
6" x 2"	IPS-FEP-6-200	Call
8" x 2"	IPS-FEP-8-200	Call

PIERCE IPS END PLUG

Size	Part No.	Price
2-1/2"	P1584-02	\$40.80
3"	P1584-03	\$40.80
4"	P1584-04	\$48.00
6"	P1584-06	\$70.80
8"	P1584-07	\$111.60
10"	P1584-08	\$141.60
12"	P1584-09	\$148.80

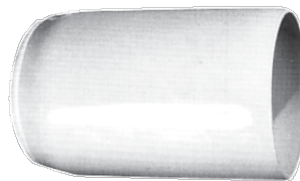

TRAVIS IPS END PLUG

Size	Part No.	Price
4"	IPS-EP-4	\$66.55
5"	IPS-EP-5	\$83.10
6"	IPS-EP-6	\$92.04
8"	IPS-EP-8	\$135.13
10"	IPS-EP-10	\$176.02
12"	IPS-EP-12	\$220.93

PIERCE IPS COMPRESSION GASKET

Size	Part No.	Price
2"	P1600-01	\$5.40
2-1/2"	P1601-01	\$5.40
3"	P1602-01	\$5.76
4"	P1603-01	\$8.40
5"	P1604-01	\$19.20
6"	P1605-01	\$12.00
8"	P1606-01	\$17.52
10"	P1607-01	\$25.20
12"	P1608-01	\$28.80



TRAVIS IPS COMPRESSION GASKET

Size	Part No.	Price
4"	IPS-CG-4	\$12.10
5"	IPS-CG-5	\$12.59
6"	IPS-CG-6	\$12.89
8"	IPS-CG-8	\$15.49
10"	IPS-CG-10	\$22.76
12"	IPS-CG-12	\$29.32

Travis Old Style with Plastic Snap Ring is Still Available. Call for Pricing.

IPS EPOXY FITTINGS

PIERCE IPS WELD-ON COUPLER

Size	Part No.	Price
2"	P1001-11	\$45.60
2-1/2"	P1001-12	\$46.80
3"	P1001-13	\$43.20
4"	P1001-14	\$44.40
5"	P1001-15	\$49.20
6"	P1001-16	\$50.40
8"	P1001-17	\$60.00
10"	P1001-18	\$86.40
12"	P1001-19	\$108.00



TRAVIS IPS WELD-ON COUPLER

Size	Part No.	Price
4"	IPS-SC-4	\$46.06
5"	IPS-SC-5	\$55.70
6"	IPS-SC-6	\$55.49
8"	IPS-SC-8	\$72.12
10"	IPS-SC-10	\$101.32
12"	IPS-SC-12	\$119.84

PIERCE IPS FLANGED ADAPTER

Size	Part No.	Price
3"	P1143-03	\$79.20
4"	P1143-04	\$86.40
6"	P1143-06	\$139.20
8"	P1143-07	\$180.00
10"	P1143-08	\$237.60
12"	P1143-09	\$261.60



TRAVIS IPS FLANGED ADAPTER

Size	Part No.	Price
4"	IPS-4004FL	\$120.65
5"	IPS-5005FL	\$158.22
6"	IPS-6006FL	\$185.59
8"	IPS-8008FL	\$248.54
10"	IPS-1010FL	\$361.99
12"	IPS-1212FL	\$428.84

PIERCE IPS REPAIR COUPLER

Size	Part No.	Price
2"	P1576-01	\$93.60
2-1/2"	P1576-02	\$96.00
3"	P1576-03	\$72.00
4"	P1578-01	\$76.80
6"	P1578-02	\$115.20
8"	P1578-03	\$148.80
10"	P1578-04	\$158.40
12"	P1579-01	\$221.20



TRAVIS IPS REPAIR COUPLER

Size	Part No.	Price
4"	IPS-RC4	\$112.13
5"	IPS-RC5	\$117.62
6"	IPS-RC6	\$118.02
8"	IPS-RC8	\$160.87
10"	IPS-RC10	\$119.44
12"	IPS-RC12	\$280.54

PIERCE IPS CROSS

Size	Part No.	Price
2-1/2"	P1494-01	\$168.00
3"	P1494-04	\$186.00
4"	P1495-01	\$232.80
6"	P1497-09	\$242.40
8"	P1497-12	\$357.60
10"	P1501-01	\$636.00
12"	P1496-10	\$1,188.00



TRAVIS IPS CROSS

Size	Part No.	Price
4"	IPSX4	\$260.78
5"	IPSX5	\$309.73
6"	IPSX6	\$338.03
8"	IPSX8	\$484.62
10"	IPSX10	\$645.59
12"	IPSX12	\$1,006.45

PIERCE IPS 90° ELBOW

Size	Part No.	Price
2"	P1552-01	\$127.20
2-1/2"	P1552-02	\$127.20
3"	P1552-03	\$134.40
4"	P1552-04	\$146.40
6"	P1554-01	\$199.20
8"	P1554-02	\$268.80
10"	P1554-03	\$379.20
12"	P1554-04	\$484.80



TRAVIS IPS 90° ELBOW

Size	Part No.	Price
4"	IPS-FE-4	\$186.37
5"	IPS-FE-5	\$230.89
6"	IPS-FE-6	\$261.14
8"	IPS-FE-8	\$322.48
10"	IPS-FE-10	\$446.34
12"	IPS-FE-12	\$553.46

Add G after part number for galvanized (same price) example - IPS-FE-4-G

PIERCE IPS 45° ELBOW

Size	Part No.	Price
2"	P1553-01	\$124.80
2-1/2"	P1553-02	\$124.80
3"	P1553-03	\$132.00
4"	P1553-04	\$146.40
6"	P1555-01	\$172.80
8"	P1555-02	\$259.20
10"	P1555-03	\$360.00
12"	P1555-04	\$439.20



TRAVIS IPS 45° ELBOW

Size	Part No.	Price
4"	IPS-FE-4-45	\$164.98
5"	IPS-FE-5-45	\$180.44
6"	IPS-FE-6-45	\$213.66
8"	IPS-FE-8-45	\$265.30
10"	IPS-FE-10-45	\$365.84
12"	IPS-FE-12-45	\$432.94

Add G after part number for galvanized (same price) example - IPS-FE-4-45-G

PIERCE IPS 22 1/2° ELBOW

Size	Part No.	Price
2"	P1564-01	\$124.80
2-1/2"	P1564-02	\$124.80
3"	P1564-03	\$132.00
4"	P1564-04	\$146.40
6"	P1564-05	\$172.80
8"	P1564-06	\$259.20
10"	P1564-07	\$357.60
12"	P1564-08	\$441.60



TRAVIS IPS 22 1/2° ELBOW

Size	Part No.	Price
4"	IPS-FE-4-22	\$164.99
5"	IPS-FE-5-22	Call
6"	IPS-FE-6-22	\$213.69
8"	IPS-FE-8-22	\$265.27
10"	IPS-FE-10-22	\$365.84
12"	IPS-FE-12-22	\$432.94

Add G after part number for galvanized (same price) example - IPS-FE-4-22-G

IPS EPOXY FITTINGS

PIERCE IPS STRAIGHT TEE

Size	Part No.	Price
2"	P1459-01	\$132.00
2-1/2"	P1457-03	\$132.00
3"	P1457-06	\$139.20
4"	P1457-09	\$156.00
6"	P1459-07	\$189.60
8"	P1459-13	\$318.00
10"	P1455-02	\$424.80
12"	P1460-10	\$717.60



TRAVIS IPS STRAIGHT TEE

Size	Part No.	Price
4"	IPS-FT-444	\$187.21
5"	IPS-FT-555	\$232.91
6"	IPS-FT-666	\$237.98
8"	IPS-FT-888	\$353.76
10"	IPS-FT-101010	\$466.84
12"	IPS-FT-121212	\$734.70

Add G after part number for galvanized (same price) example - IPS-FT-G-444

PIERCE IPS REDUCING TEE

Size	Part No.	Price
2" x 2" x 3"	P1462-02	\$180.00
3" x 2" x 2"	P1480-03	\$170.40
3" x 2" x 3"	P1480-05	\$146.40
3" x 3" x 2"	P1457-04	\$110.40
3" x 3" x 4"	P1462-10	\$180.00
4" x 2" x 2"	P1477-01	\$175.20
4" x 2" x 4"	P1480-11	\$159.60
4" x 3" x 3"	P1480-15	\$146.40
4" x 3" x 4"	P1480-16	\$148.80
4" x 4" x 2"	P1456-01	\$117.60
4" x 4" x 3"	P1457-08	\$120.00
4" x 4" x 6"	P1462-15	\$280.80
6" x 3" x 3"	P1485-12	\$201.60
6" x 3" x 6"	P1485-15	\$223.20
6" x 4" x 4"	P1480-19	\$223.20
6" x 6" x 2"	P1456-02	\$129.60
6" x 6" x 3"	P1459-04	\$162.00
6" x 6" x 4"	P1459-05	\$189.60
6" x 6" x 8"	P1462-18	\$360.00
8" x 4" x 4"	P1485-18	\$295.20
8" x 4" x 8"	P1485-21	\$338.40
8" x 6" x 6"	P1481-05	\$278.40
8" x 8" x 3"	P1459-09	\$244.80
8" x 8" x 4"	P1459-10	\$249.60
8" x 8" x 6"	P1459-12	\$255.60
8" x 8" x 10"	P1462-19	\$535.20
10" x 6" x 6"	P1485-30	\$391.20
10" x 6" x 10"	P1486-05	\$669.60
10" x 8" x 8"	P1482-02	\$890.40
10" x 8" x 10"	P1482-03	\$645.60
10" x 10" x 2"	P1458-02	\$276.00
10" x 10" x 3"	P1459-15	\$336.00
10" x 10" x 4"	P1459-16	\$295.20
10" x 10" x 6"	P1459-18	\$350.40
10" x 10" x 8"	P1455-01	\$386.40
10" x 10" x 12"	P1462-20	\$897.60
12" x 12" x 4"	P1460-05	\$398.40
12" x 12" x 6"	P1460-07	\$566.40
12" x 12" x 8"	P1460-08	\$572.40
12" x 12" x 10"	P1460-09	\$717.60



TRAVIS IPS REDUCING TEE

Size	Part No.	Price
2" x 2" x 3"	IPS-RT-223	Call
3" x 2" x 2"	IPS-RT-322	Call
3" x 2" x 3"	IPS-RT-323	Call
3" x 3" x 2"	IPS-RT-332	Call
3" x 3" x 4"	IPS-RT-334	Call
4" x 2" x 2"	IPS-RT-422	Call
4" x 2" x 4"	IPS-RT-424	Call
4" x 3" x 3"	IPS-RT-433	Call
4" x 3" x 4"	IPS-RT-434	Call
4" x 4" x 2"	IPS-RT-442	Call
4" x 4" x 3"	IPS-RT-443	\$207.65
4" x 4" x 6"	IPS-RT-446	Call
6" x 3" x 3"	IPS-RT-633	Call
6" x 3" x 6"	IPS-RT-636	Call
6" x 4" x 4"	IPS-RT-644	Call
6" x 6" x 2"	IPS-RT-662	Call
6" x 6" x 3"	IPS-RT-663	\$239.22
6" x 6" x 4"	IPS-RT-664	\$228.49
6" x 6" x 8"	IPS-RT-668	Call
8" x 4" x 4"	IPS-RT-844	Call
8" x 4" x 8"	IPS-RT-848	Call
8" x 6" x 6"	IPS-RT-866	\$304.86
8" x 8" x 3"	IPS-RT-883	Call
8" x 8" x 4"	IPS-RT-884	Call
8" x 8" x 6"	IPS-RT-886	\$304.86
8" x 8" x 10"	IPS-RT-8810	Call
10" x 6" x 6"	IPS-RT-1066	Call
10" x 6" x 10"	IPS-RT-10610	Call
10" x 8" x 8"	IPS-RT-1088	Call
10" x 8" x 10"	IPS-RT-10810	Call
10" x 10" x 2"	IPS-RT-10102	Call
10" x 10" x 3"	IPS-RT-10103	Call
10" x 10" x 4"	IPS-RT-10104	Call
10" x 10" x 6"	IPS-RT-10106	\$369.34
10" x 10" x 8"	IPS-RT-10108	\$486.44
10" x 10" x 12"	IPS-RT-101012	Call
12" x 12" x 4"	IPS-RT-12124	Call
12" x 12" x 6"	IPS-RT-12126	\$564.02
12" x 12" x 8"	IPS-RT-12128	\$602.96
12" x 12" x 10"	IPS-RT-121210	\$691.90

Add G after part number for galvanized (same price) example - IPS-RT-G-443

Note: 2-1/2" Reducing Tees are also available & will be quoted upon request.

STEEL SADDLE WITH STUB

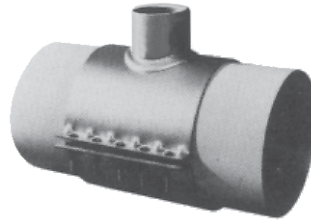

TRAVIS GALVANIZED WITH 4" PLAIN END STUB

Size	Part No.	Price
5"	SSG-45	\$112.24
6"	SSG-46	\$108.94
8"	SSG-48	\$127.00
10"	SSG-410	\$153.05
12"	SSG-412	\$163.93
15"	SSG-415	\$219.29

TRAVIS EPOXY WITH 4" PLAIN END STUB

Size	Part No.	Price
5"	SSE-45	\$121.03
6"	SSE-46	\$119.39
8"	SSE-48	\$137.88
10"	SSE-410	\$167.08
12"	SSE-412	\$209.48
15"	SSE-415	\$232.70

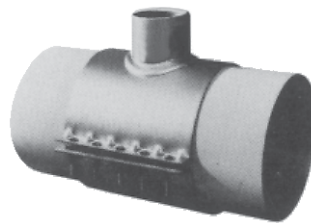

TRAVIS GALVANIZED WITH 6" PLAIN END STUB

Size	Part No.	Price
8"	SSG-68	\$182.60
10"	SSG-610	\$201.30
12"	SSG-612	\$241.08
15"	SSG-615	\$300.02

TRAVIS EPOXY WITH 6" PLAIN END STUB

Size	Part No.	Price
8"	SSE-68	\$190.34
10"	SSE-610	\$214.43
12"	SSE-612	\$248.88
15"	SSE-615	\$320.24

STEEL SADDLE WITH 3" FIPT OUTLET

PIERCE GALVANIZED WITH 3" FIPT OUTLET

Size	Part No.	Price
6"	P1311-92	\$127.20
8"	P1312-92	\$139.20
10"	P1313-92	\$146.40
12"	P1314-92	\$163.20

PIERCE EPOXY WITH 3" FIPT OUTLET

Size	Part No.	Price
6"	P1311-82	\$144.00
8"	P1312-82	\$151.20
10"	P1313-82	\$180.00
12"	P1314-82	\$190.80

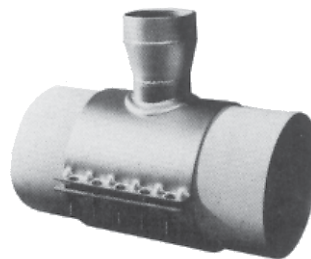

TRAVIS GALVANIZED WITH 3" FIPT OUTLET

Size	Part No.	Price
5"	SSG-TF-35	\$136.06
6"	SSG-TF-36	\$146.45
8"	SSG-TF-38	\$160.76
10"	SSG-TF-310	\$186.00
12"	SSG-TF-312	\$209.33
15"	SSG-TF-315	\$248.44

TRAVIS EPOXY WITH 3" FIPT OUTLET

Size	Part No.	Price
5"	SSE-TF-35	\$141.28
6"	SSE-TF-36	\$151.36
8"	SSE-TF-38	\$166.40
10"	SSE-TF-310	\$193.81
12"	SSE-TF-312	\$217.66
15"	SSE-TF-315	\$263.18

STEEL SADDLE WITH 4" FIPT OUTLET

PIERCE GALVANIZED WITH 4" FIPT OUTLET

Size	Part No.	Price
6"	P1311-93	\$148.00
8"	P1312-93	\$162.00
10"	P1313-93	\$172.80
12"	P1314-93	\$187.20

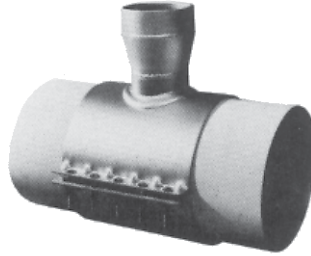

TRAVIS GALVANIZED WITH 4" FIPT OUTLET

Size	Part No.	Price
5"	SSG-TF-45	\$150.04
6"	SSG-TF-46	\$160.22
8"	SSG-TF-48	\$169.73
10"	SSG-TF-410	\$194.76
12"	SSG-TF-412	\$218.24
15"	SSG-TF-415	\$260.47

PIERCE EPOXY WITH 4" FIPT OUTLET

Size	Part No.	Price
6"	P1311-83	\$146.40
8"	P1312-83	\$180.00
10"	P1313-83	\$186.00
12"	P1314-83	\$196.80

TRAVIS EPOXY WITH 4" FIPT OUTLET

Size	Part No.	Price
5"	SSE-TF-45	\$155.54
6"	SSE-TF-46	\$164.86
8"	SSE-TF-48	\$175.75
10"	SSE-TF-410	\$203.14
12"	SSE-TF-412	\$226.91
15"	SSE-TF-415	\$275.18

STEEL SADDLE WITH 6" FIPT OUTLET

TRAVIS GALVANIZED WITH 6" FIPT OUTLET

Size	Part No.	Price
8"	SSG-TF-68	\$230.66
10"	SSG-TF-610	\$246.96
12"	SSG-TF-612	\$271.84
15"	SSG-TF-615	\$321.66

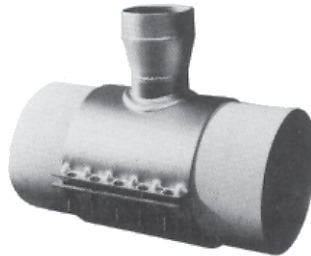

TRAVIS EPOXY WITH 6" FIPT OUTLET

Size	Part No.	Price
8"	SSE-TF-68	\$236.66
10"	SSE-TF-610	\$254.93
12"	SSE-TF-612	\$280.76
15"	SSE-TF-615	\$338.03

STEEL SADDLE WITH 3" MIPT OUTLET

TRAVIS GALVANIZED WITH 3" MIPT OUTLET

Size	Part No.	Price
5"	SSG-TM-35	\$136.04
6"	SSG-TM-36	\$146.45
8"	SSG-TM-38	\$160.76
10"	SSG-TM-310	\$186.00
12"	SSG-TM-312	\$213.41
15"	SSG-TM-315	\$253.27



TRAVIS EPOXY WITH 3" MIPT OUTLET

Size	Part No.	Price
5"	SSE-TM-35	\$141.28
6"	SSE-TM-36	\$151.36
8"	SSE-TM-38	\$166.39
10"	SSE-TM-310	\$193.81
12"	SSE-TM-312	\$221.87
15"	SSE-TM-315	\$268.31

STEEL SADDLE WITH 4" MIPT OUTLET



TRAVIS GALVANIZED W/ 4" MIPT OUTLET

Size	Part No.	Price
5"	SSG-TM-45	\$144.79
6"	SSG-TM-46	\$154.94
8"	SSG-TM-48	\$169.06
10"	SSG-TM-410	\$194.24
12"	SSG-TM-412	\$221.66
15"	SSG-TM-415	\$260.17

TRAVIS EPOXY WITH 4" MIPT OUTLET

Size	Part No.	Price
5"	SSE-TM-45	\$151.99
6"	SSE-TM-46	\$159.58
8"	SSE-TM-48	\$174.65
10"	SSE-TM-410	\$202.09
12"	SSE-TM-412	\$230.10
15"	SSE-TM-415	\$275.21

STEEL SADDLE WITH 36" RISER AND 4" VALVE

PIERCE GALVANIZED WITH 36" RISER & 4" VALVE

Size	Part No.	Price
6"	P3586-85	\$252.00
8"	P3672-85	\$256.80
10"	P3670-85	\$261.60
12"	P3671-85	\$268.80



TRAVIS GALVANIZED WITH 36" RISER & 4" VALVE

Size	Part No.	Price
5"	SSG-436-5	\$203.69
6"	SSG-436-6	\$204.85
8"	SSG-436-8	\$218.71
10"	SSG-436-10	\$229.19
12"	SSG-436-12	\$257.16
15"	SSG-436-15	\$320.58

PIERCE EPOXY WITH 36" RISER & 4" VALVE

Size	Part No.	Price
6"	P1320-85	\$230.40
8"	P1323-85	\$252.00
10"	P1326-85	\$271.20
12"	P1329-85	\$300.00

TRAVIS EPOXY WITH 36" RISER & 4" VALVE

Size	Part No.	Price
5"	SSE-436-5	\$223.34
6"	SSE-436-6	\$223.52
8"	SSE-436-8	\$233.81
10"	SSE-436-10	\$253.78
12"	SSE-436-12	\$280.18
15"	SSE-436-15	\$343.20

STEEL SADDLE WITH 36" RISER AND 6" VALVE



TRAVIS GALVANIZED WITH 36" RISER & 6" VALVE

Size	Part No.	Price
8"	SSG-636-8	\$308.96
10"	SSG-636-10	\$351.12
12"	SSG-636-12	\$393.10
15"	SSG-636-15	\$468.10

TRAVIS EPOXY WITH 36" RISER & 6" VALVE

Size	Part No.	Price
8"	SSE-636-8	\$326.58
10"	SSE-636-10	\$369.23
12"	SSE-636-12	\$410.98
15"	SSE-636-15	\$491.83



**TRAVIS
BOLT TITE DISCHARGE ADAPTER**

IPS

Coupler Size	Flange Size	Part No.	Price
4"	2"	IPSBTDA204	\$159.38
4"	3"	IPSBTDA304	\$185.63
4"	4"	IPSBTDA404	\$192.05
5"	3"	IPSBTDA305	\$192.05
5"	4"	IPSBTDA405	\$205.55
5"	5"	IPSBTDA505	\$215.63
6"	3"	IPSBTDA306	\$266.17
6"	4"	IPSBTDA406	\$274.00
6"	5"	IPSBTDA506	\$274.00
6"	6"	IPSBTDA606	\$274.00
8"	4"	IPSBTDA408	\$295.19
8"	5"	IPSBTDA508	\$352.82
8"	6"	IPSBTDA608	\$366.10
8"	8"	IPSBTDA808	\$373.38
10"	4"	IPSBTDA410	\$469.01
10"	5"	IPSBTDA510	\$469.01
10"	6"	IPSBTDA610	\$471.90
10"	8"	IPSBTDA810	\$471.90
10"	10"	IPSBTDA1010	\$474.76
12"	8"	IPSBTDA812	\$546.38
12"	10"	IPSBTDA1012	\$507.28
12"	12"	IPSBTDA1212	\$485.62



**TRAVIS
BOLT TITE 90° ELBOW**

IPS

Size	Part No.	Price
4"	IPSBTFE4	\$224.33
5"	IPSBTFE5	\$239.09
6"	IPSBTFE6	\$285.89
8"	IPSBTFE8	\$346.67
10"	IPSBTFE10	\$417.38
12"	IPSBTFE12	\$640.25



**TRAVIS
BOLT TITE 45° ELBOW**

IPS

Size	Part No.	Price
4"	IPSBTFE4-45	\$177.67
5"	IPSBTFE5-45	\$210.36
6"	IPSBTFE6-45	\$248.59
8"	IPSBTFE8-45	\$299.26
10"	IPSBTFE10-45	\$365.66
12"	IPSBTFE12-45	\$585.95

PIP

Size	Part No.	Price
6"	PIPBTFE6-45	\$248.59
8"	PIPBTFE8-45	\$299.26
10"	PIPBTFE10-45	\$365.66
12"	PIPBTFE12-45	\$585.95
15"	PIPBTFE15-45	\$674.17
18.7"	PIPBTFE18.7-45	\$1,035.44
20.4"	PIPBTFE20.4-45	\$1,151.54



**TRAVIS BOLT TITE MALE
THREADED RISER COUPLER 10"**

IPS

Coupler Size	Thread Size	Part No.	Price
4" x 10"	3"	IPS10BT43MT	\$163.88
5" x 10"	3"	IPS10BT53MT	\$169.32
6" x 10"	3"	IPS10BT63MT	\$190.76
8" x 10"	3"	IPS10BT83MT	\$214.12
10" x 10"	3"	IPS10BT103MT	\$256.22
12" x 10"	3"	IPS10BT123MT	\$384.20
4" x 10"	4"	IPS10BT44MT	\$178.13
5" x 10"	4"	IPS10BT54MT	\$184.33
6" x 10"	4"	IPS10BT64MT	\$205.92
8" x 10"	4"	IPS10BT84MT	\$231.66
10" x 10"	4"	IPS10BT104MT	\$265.94
12" x 10"	4"	IPS10BT124MT	\$400.06

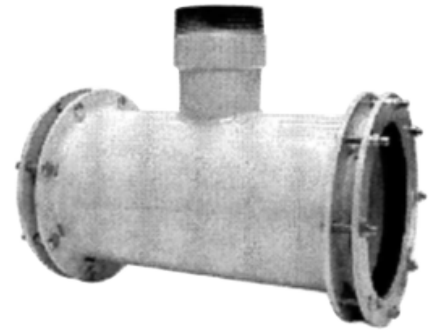

**TRAVIS BOLT TITE MALE
THREADED RISER COUPLER 18"**

IPS

Coupler Size	Thread Size	Part No.	Price
4" x 18"	3"	IPS18BT43MT	\$218.16
5" x 18"	3"	IPS18BT53MT	\$231.88
6" x 18"	3"	IPS18BT63MT	\$263.08
8" x 18"	3"	IPS18BT83MT	\$313.09
10" x 18"	3"	IPS18BT103MT	\$368.33
12" x 18"	3"	IPS18BT123MT	\$556.07
4" x 18"	4"	IPS18BT44MT	\$235.96
5" x 18"	4"	IPS18BT54MT	\$249.86
6" x 18"	4"	IPS18BT64MT	\$281.47
8" x 18"	4"	IPS18BT84MT	\$330.46
10" x 18"	4"	IPS18BT104MT	\$386.22
12" x 18"	4"	IPS18BT124MT	\$576.76



**TRAVIS BOLT TITE FEMALE
THREADED RISER COUPLER 10"**

IPS

Coupler Size	Thread Size	Part No.	Price
4" x 10"	3"	IPS10BT43FT	\$171.54
5" x 10"	3"	IPS10BT53FT	\$176.99
6" x 10"	3"	IPS10BT63FT	\$198.42
8" x 10"	3"	IPS10BT83FT	\$221.78
10" x 10"	3"	IPS10BT103FT	\$269.04
12" x 10"	3"	IPS10BT123FT	\$391.84
4" x 10"	4"	IPS10BT44FT	\$187.14
5" x 10"	4"	IPS10BT54FT	\$193.36
6" x 10"	4"	IPS10BT64FT	\$214.79
8" x 10"	4"	IPS10BT84FT	\$240.68
10" x 10"	4"	IPS10BT104FT	\$274.98
12" x 10"	4"	IPS10BT124FT	\$400.46

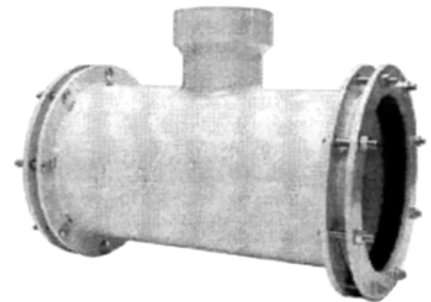

**TRAVIS BOLT TITE FEMALE
THREADED RISER COUPLER 18"**

IPS

Coupler Size	Thread Size	Part No.	Price
4" x 18"	3"	IPS18BT43FT	\$225.84
5" x 18"	3"	IPS18BT53FT	\$239.53
6" x 18"	3"	IPS18BT63FT	\$270.71
8" x 18"	3"	IPS18BT83FT	\$320.72
10" x 18"	3"	IPS18BT103FT	\$375.98
12" x 18"	3"	IPS18BT123FT	\$563.72
4" x 18"	4"	IPS18BT44FT	\$245.02
5" x 18"	4"	IPS18BT54FT	\$249.86
6" x 18"	4"	IPS18BT64FT	\$290.51
8" x 18"	4"	IPS18BT84FT	\$340.28
10" x 18"	4"	IPS18BT104FT	\$395.26
12" x 18"	4"	IPS18BT124FT	\$585.77



TRAVIS BOLT TITE TEE

IPS

Size	Part No.	Price
4"	IPSBTFT4	\$267.13
5"	IPSBTFT5	\$294.98
6"	IPSBTFT6	\$337.08
8"	IPSBTFT8	\$417.38
10"	IPSBTFT10	\$516.05
12"	IPSBTFT12	\$830.47



TRAVIS BOLT TITE CROSS

IPS

Size	Part No.	Price
4"	IPSBTX4	\$350.14
5"	IPSBTX5	\$379.91
6"	IPSBTX6	\$449.10
8"	IPSBTX8	\$556.15
10"	IPSBTX10	\$693.80
12"	IPSBTX12	\$1,106.36

BOLT TITE & WEDGE-TITE® GASKET

PIERCE IPS WEDGE-TITE® GASKETS

Size	Part No.	Price
4"	P1640-02	\$3.72
5"	P1640-03	\$6.84
6"	P1640-04	\$4.80
8"	P1640-05	\$6.00
10"	P1640-06	\$7.20
12"	P1640-07	\$20.10



TRAVIS IPS BOLT TITE GASKETS

Size	Part No.	Price
4"	IPSBTG4	\$7.68
5"	IPSBTG5	\$10.13
6"	IPSBTG6	\$12.49
8"	IPSBTG8	\$14.52
10"	IPSBTG10	\$24.86
12"	IPSBTG12	\$29.82

BOLT TITE & WEDGE-TITE® FITTINGS



PIERCE WEDGE-TITE® WELD-ON COUPLER SET

Size	IPS Part No.	PIP Part No.	Nominal Part No.	Price
4"	P9017-01	P9017-03	P9017-05	\$93.30
5"	P9018-01	-	P9018-03	\$103.20
6"	P9019-01	P9019-03	P9019-05	\$117.60
8"	P9020-01	P9020-03	P9020-05	\$156.00
10"	P9021-01	P9021-03	P9021-05	\$192.00
12"	P9022-01	P9022-03	P9022-05	\$225.60
15"	-	P9023-01	-	\$348.00
18"	-	P2294-26	-	\$516.00



TRAVIS BOLT TITE WELD-ON COUPLER SET

Size	IPS Part No.	Price
4"	IPS-BTSC-4	\$77.22
5"	IPS-BTSC-5	\$85.94
6"	IPS-BTSC-6	\$99.96
8"	IPS-BTSC-8	\$126.85
10"	IPS-BTSC-10	\$154.92
12"	IPS-BTSC-12	\$238.01

PIERCE WEDGE-TITE® WELD-ON COUPLER

Size	Part No.	Price
4"	P1591-12	\$57.60
5"	P1591-13	\$62.40
6"	P1591-14	\$76.80
8"	P1591-15	\$103.20
10"	P1591-16	\$122.40
12"	P1591-17	\$144.00
15"	P2294-25	\$235.20
18"	P2294-29	\$328.80



TRAVIS BOLT TITE WELD-ON COUPLER

Size	Part No.	Price
4"	BTBS-4	\$44.99
5"	BTBS-5	\$50.68
6"	BTBS-6	\$58.87
8"	BTBS-8	\$77.05
10"	BTBS-10	\$95.51
12"	BTBS-12	\$149.70
15"	BTBS-15	\$186.30
18.7"	BTBS-18.7	\$256.02
20.4"	BTBS-20.4	\$277.15

PIERCE WEDGE-TITE® FLANGE PACK OPTIONS

Size	IPS Part No.	PIP Part No.	Nominal Part No.	Price
4"	P1641-02	P1642-01	P1643-02	\$34.80
5"	P1641-03	-	P1643-03	\$39.60
6"	P1641-04	P1642-02	P1643-04	\$42.00
8"	P1641-05	P1642-03	P1643-05	\$46.80
10"	P1641-06	P1642-04	P1643-06	\$60.00
12"	P1641-07	P1642-05	P1643-07	\$79.20
15"	-	P1642-06	-	\$112.80
18"	-	P1642-07	-	\$204.00



TRAVIS BOLT TITE FLANGE PACK OPTIONS

Size	IPS Part No.	Price
4"	IPS-SFP-4	\$32.23
5"	IPS-SFP-5	\$35.27
6"	IPS-SFP-6	\$41.09
8"	IPS-SFP-8	\$49.80
10"	IPS-SFP-10	\$59.40
12"	IPS-SFP-12	\$88.32

BOLTED REPAIR COUPLINGS



**PIERCE
WEDGE-TITE® REPAIR COUPLER SET 10" BODY**

Size	IPS Part No.	PIP Part No.	Nominal Part No.	Price
4"	P9075-01	P9075-03	P9075-05	\$91.20
5"	P9076-01	-	P9076-04	\$105.60
6"	P9077-01	P9077-03	P9077-05	\$118.80
8"	P9078-01	P9078-03	P9078-05	\$141.60
10"	P9079-01	P9079-03	P9079-05	\$186.00
12"	P9080-01	P9080-03	P9080-05	\$243.60
15"	-	P9081-01	-	\$346.80



**TRAVIS
BOLT TITE COUPLER SET 10" BODY**

Size	IPS Part No.	Price
4"	IPS-BT-4-10	\$93.72
5"	IPS-BT-5-10	\$108.72
6"	IPS-BT-6-10	\$122.98
8"	IPS-BT-8-10	\$149.64
10"	IPS-BT-10-10	\$190.08
12"	IPS-BT-12-10	\$279.26

PIERCE WEDGE-TITE® 10" COUPLER BODY ONLY

Size	Part No.	Price
4"	P1594-12	\$50.40
5"	P1594-13	\$52.80
6"	P1594-14	\$55.20
8"	P1594-15	\$74.40
10"	P1594-16	\$76.80
12"	P1594-17	\$100.80
15"	P1594-18	\$158.40



TRAVIS BOLT TITE 10" COUPLER BODY ONLY

Size	Part No.	Price
4"	BTB-4-10	\$37.49
5"	BTB-5-10	\$43.51
6"	BTB-6-10	\$49.20
8"	BTB-8-10	\$59.86
10"	BTB-10-10	\$76.01
12"	BTB-12-10	\$111.71
15"	BTB-15-10	\$138.48

PIERCE WEDGE-TITE® 10" BODY FLANGE PACKS

Size	IPS Part No.	PIP Part No.	Nominal Part No.	Price
4"	P1647-02	P1648-01	P1649-02	\$49.20
5"	P1647-03	-	P1649-03	\$57.60
6"	P1647-04	P1648-02	P1649-04	\$64.80
8"	P1647-05	P1648-03	P1649-05	\$81.60
10"	P1647-06	P1648-04	P1649-06	\$114.00
12"	P1647-07	P1648-05	P1649-07	\$136.80
15"	-	P1648-06	-	\$188.40



TRAVIS BOLT TITE 10" BODY FLANGE PACKS

Size	IPS Part No.	Price
4"	IPS-LFP-4	Call
5"	IPS-LFP-5	Call
6"	IPS-LFP-6	\$73.78
8"	IPS-LFP-8	\$89.78
10"	IPS-LFP-10	\$114.06
12"	IPS-LFP-12	\$167.59

BOLTED REPAIR COUPLINGS



**PIERCE
WEDGE-TITE® REPAIR COUPLER SET 16" BODY**

Size	IPS Part No.	PIP Part No.	Nominal Part No.	Price
4"	P9083-01	P9083-03	P9083-05	\$156.00
5"	P9084-01	-	P9084-03	\$172.80
6"	P9085-01	P9085-03	P9085-05	\$205.20
8"	P9086-01	P9086-03	P9086-05	\$247.20
10"	P9087-01	P9087-03	P9087-05	\$310.80
12"	P9088-01	P9088-03	P9088-05	\$397.20
15"	-	P9089-01	-	\$628.80
18"	-	P2293-56	-	\$974.40



**TRAVIS
BOLT TITE REPAIR COUPLER SET 18" BODY**

Size	IPS Part No.	Price
4"	IPS-BT-4-18	\$149.86
5"	IPS-BT-5-18	\$167.21
6"	IPS-BT-6-18	\$200.42
8"	IPS-BT-8-18	\$250.25
10"	IPS-BT-10-18	\$305.14
12"	IPS-BT-12-18	\$470.39

PIERCE WEDGE-TITE® 16" COUPLER BODY ONLY

Size	Part No.	Price
4"	P1595-12	\$91.20
5"	P1595-13	\$117.60
6"	P1595-14	\$127.20
8"	P1595-15	\$146.40
10"	P1595-16	\$174.00
12"	P1595-17	\$201.60
15"	P2293-25	\$314.40
18"	P2293-26	\$578.40



TRAVIS BOLT TITE 18" COUPLER BODY ONLY

Size	Part No.	Price
4"	BTB-4-18	\$97.40
5"	BTB-5-18	\$108.68
6"	BTB-6-18	\$130.26
8"	BTB-8-18	\$162.60
10"	BTB-10-18	\$198.34
12"	BTB-12-18	\$305.74
15"	BTB-15-18	\$401.09
18.7"	BTB-18.7-18	\$520.25
20.4"	BTB-20.4-18	\$586.09

PIERCE WEDGE-TITE® 16" BODY FLANGE PACKS

Size	IPS Part No.	PIP Part No.	Nominal Part No.	Price
4"	P1641-02	P1642-01	P1643-02	\$34.80
5"	P1641-03	-	P1643-03	\$39.60
6"	P1641-04	P1642-02	P1643-04	\$42.00
8"	P1641-05	P1642-03	P1643-05	\$46.80
10"	P1641-06	P1642-04	P1643-06	\$60.00
12"	P1641-07	P1642-05	P1643-07	\$79.20
15"	-	P1642-06	-	\$112.80
18"	-	P1642-07	-	\$204.00



TRAVIS BOLT TITE 18" BODY FLANGE PACKS

Size	IPS Part No.	Price
4"	IPS-FP-4	\$52.45
5"	IPS-FP-5	\$58.52
6"	IPS-FP-6	\$70.16
8"	IPS-FP-8	\$87.59
10"	IPS-FP-10	\$106.80
12"	IPS-FP-12	\$164.64

TRANSITIONAL BOLTED REPAIR COUPLINGS

POWER SEAL HEAVY DUTY CAST IRON BOLTED TRANSITION COUPLING

This high quality coupler is designed & manufactured for irrigation, municipal & industrial applications. Additional coupler sizes are available upon request. To order, any combination of pipe O.D. ranges can be paired within a nominal pipe size to make a transition connection. Example: to connect 4" IPS steel or PVC (4.50" O.D.) to 4" asbestos cement (5.33" O.D.) order the 3501-4AC coupling.

MODEL 3501 SHORT TRANSITION COUPLING - 6" LENGTH

Part No.	Size	Pipe OD Range	Letter Code	Flanged Color	Bolt Qty	Price
350104OD0000	4"	4.00 - 4.13	OD	White	4	\$178.66
350104AA0000		4.20 - 4.50	AA	Green		
350104A00000		4.50 - 4.85	A	Blue		
350104B00000		4.80 - 5.10	B	Black		
350104C00000		5.05 - 5.40	C	Grey		
350106OD0000	6"	6.00 - 6.14	OD	White	5	\$229.13
350106AA0000		6.27 - 6.72	AA	Green		
350106A00000		6.62 - 6.95	A	Blue		
350106B00000		6.90 - 7.22	B	Black		
350106C00000		7.19 - 7.45	C	Grey		
350108OD0000	8"	8.00 - 8.16	OD	White	6	\$289.61
350108AA0000		8.40 - 8.82	AA	Green		
350108A00000		8.62 - 9.05	A	Blue		
350108B00000		9.05 - 9.45	B	Black		
350108C00000		9.10 - 9.79	C	Grey		
350110A00000	10"	10.70 - 11.10	A	Blue	7	\$402.16
350110B00000		11.10 - 11.50	B	Black		
350110C00000		11.60 - 12.12	C	Grey		



MODEL 3501 LONG TRANSITION COUPLING - 12" LENGTH

Part No.	Size	Pipe OD Range	Letter Code	Flanged Color	Bolt Qty	Price
350104OD00LB	4"	4.00 - 4.13	OD	White	4	\$369.90
350104AA00LB		4.20 - 4.50	AA	Green		
350104A000LB		4.50 - 4.85	A	Blue		
350104B000LB		4.80 - 5.10	B	Black		
350104C000LB		5.05 - 5.40	C	Grey		
350106OD00LB	6"	6.00 - 6.14	OD	White	5	\$455.81
350106AA00LB		6.27 - 6.72	AA	Green		
350106A000LB		6.62 - 6.95	A	Blue		
350106B000LB		6.90 - 7.22	B	Black		
350106C000LB		7.19 - 7.45	C	Grey		
350108OD00LB	8"	8.00 - 8.16	OD	White	6	\$582.65
350108AA00LB		8.40 - 8.82	AA	Green		
350108A000LB		8.62 - 9.05	A	Blue		
350108B000LB		9.05 - 9.45	B	Black		
350108C000LB		9.10 - 9.79	C	Grey		
350110A000LB	10"	10.70 - 11.10	A	Blue	7	\$804.01
350110B000LB		11.10 - 11.50	B	Black		
350110C000LB		11.60 - 12.12	C	Grey		



PIPE REPAIR CLAMPS

Save Time, Labor & Money by using these high quality repair clamps for repairing above & below ground leaks & broken pipelines. They are NSF approved & manufactured with type 304 stainless steel armor plate & panel, 1/4" thick nitrile (Buna-N NBR) Chek-O-Seal rubber gasket, ductile iron lugs & low alloy steel nuts & bolts. When ordering, specify model number, pipe size with letter code, & replace XX with width. Example: 6" cast iron O.D. 6.90" with 12" clamp width. Order 312106C120AA-SB .

POWER SEAL MODEL 3121 IRON LUG SINGLE PANEL PIPE REPAIR CLAMP

Part No.	Pipe Size	Range In.	Letter Code	W = Width					
				8"	10"	12"	16"	20"	24"
3121012XX0AA-SB	1-1/4"	1.66	A	\$125.36	\$188.81	\$222.44	\$255.82	\$294.04	\$337.99
3121015XX0AA-SB	1-1/2"	1.88-1.92	B	\$125.36	\$188.81	\$222.44	\$255.82	\$294.04	\$338.00
3121020XX0AA-SB	2"	2.35-2.63	A	\$125.36	\$188.81	\$222.44	\$255.82	\$294.04	\$337.99
3121025XX0AA-SB	2-1/2"	2.70-3.00	B	\$136.06	\$201.55	\$237.86	\$274.17	\$315.06	\$362.07
312103AXX0AA-SB	3"	2.97-3.25	A	\$152.50	\$218.19	\$254.29	\$302.96	\$348.18	\$400.29
312103BXX0AA-SB		3.46-3.70	B						
312103CXX0AA-SB		3.73-4.00	C						
312103DXX0AA-SB		3.96-4.25	D						
312104AXX0AA-SB	4"	4.45-4.73	A	\$169.32	\$228.94	\$277.48	\$334.68	\$449.47	\$564.51
312104BXX0AA-SB		4.74-5.14	B						
312104CXX0AA-SB		4.95-5.35	C						
312104DXX0AA-SB		5.22-5.62	D						
312106AXX0AA-SB	6"	5.95-6.35	A	\$199.76	\$270.98	\$245.78	\$371.37	\$538.14	\$656.24
312106BXX0AA-SB		6.56-6.96	B						
312106CXX0AA-SB		6.84-7.24	C						
312106DXX0AA-SB		7.05-7.45	D						
312106EXX0AA-SB		7.45-7.85	E						
312108AXX0AA-SB	8"	7.95-8.35	A	\$238.24	\$316.21	\$382.71	\$456.22	\$631.78	\$755.86
312108BXX0AA-SB		8.54-8.94	B						
312108CXX0AA-SB		8.99-9.39	C						
312108DXX0AA-SB		9.27-9.67	D						
312110AXX0AA-SB	10"	9.70-10.10	A	\$290.85	\$393.03	\$451.89	\$569.61	\$761.34	\$854.28
312110BXX0AA-SB		10.64-11.04	B						
312110CXX0AA-SB		11.04-11.44	C						
312110DXX0AA-SB		11.34-11.74	D						
312110EXX0AA-SB		11.75-12.15	E						
312112AXX0AA-SB	12"	12.00-12.40	A	\$328.18	\$436.47	\$528.07	\$656.24	\$866.70	\$1,012.19
312112BXX0AA-SB		12.62-13.02	B						
312112CXX0AA-SB		13.10-13.50	C						
312112DXX0AA-SB		13.40-13.80	D						
312112EXX0AA-SB		13.70-14.10	E						
312112FXX0AA-SB		14.00-14.40	F						



NOTE: Stocked widths shown above. 30" Widths available by special order.

POWER SEAL PIPE REPAIR CLAMP WITH TAPPED OUTLET

To add-on a female iron thread tapped outlet to a repair clamp, add the outlet size to the end of the part number.. Combine the pipe repair clamp price listed above with the outlet list price add-on listed below for a total list price.



POWER SEAL MODEL 3141 IRON LUG COLLAR LEAK

Similar to model 3121 pipe repair clamps, but used to provide a simple & permanent repair for leaking solvent weld PVC bells & collars as well as threaded steel pipe collars. These are not recommended for leaking push-on-joint gasketed bells. When ordering: Specify Model Number, Pipe Size with Collar Type, and Width. EXAMPLE: 4" Steel O.D. 450 with 6" wide Schedule 40 Collar. Order 3141 - 4" Sch 40 x 8. Part Number: 3141040080HA .

Part No.	Pipe Size	Range	Collar Type	8" Width
3141040080AH	4"	4.50"	Sch. 40 Collar	\$226.04
3141040080AU		4.50"	SDR 26 Bell	
3141040080AV		4.13"	PIP 80# Bell	
3141060080AH	6"	6.63"	Sch. 40 Collar	\$278.77
3141060080AU		6.63"	SDR 26 Bell	
3141060080AV		6.14"	PIP 80# Bell	
3141080080AH	8"	8.63"	Sch. 40 Collar	\$311.06
3141080080AU		8.63"	SDR 26 Bell	
3141080080AV		8.14"	PIP 80# Bell	
3141100080AH	10"	10.75"	Sch. 40 Collar	\$314.34
3141100080AU		10.75"	SDR 26 Bell	
3141100080AV		10.20"	PIP 80# Bell	
3141120080AH	12"	12.75"	Sch. 40 Collar	\$417.77
3141120080AU		12.75"	SDR 26 Bell	
3141120080AV		12.24"	PIP 80# Bell	
3141150080AV	15"	15.30"	PIP 80# Bell	\$551.62

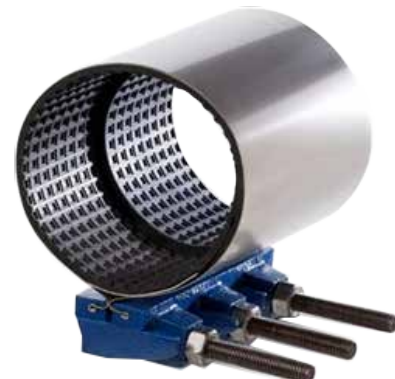

PATCH CLAMPS

6" WIDE - 2 BOLT FOR IPS PIPE

Part No.	Pipe Size	Box Qty.	Price
330-026	3/8"	3	\$24.21
330-036	1/2"	3	\$24.21
330-046	3/4"	3	\$24.57
330-056	1"	3	\$27.41
330-066	1-1/4"	3	\$29.94
330-076	1-1/2"	3	\$32.43
330-086	2"	2	\$42.54
330-096	2-1/2"	2	\$45.65
330-106	3"	2	\$49.70
330-1056	3-1/2"	1	\$53.91
330-116	4"	1	\$55.72
330-126	5"	1	\$60.57
330-136	6"	1	\$63.60
330-1356	7"	1	\$74.37
330-146	8"	1	\$74.54
330-156	10"	1	\$130.54
330-166	12"	1	\$142.74



6" WIDE - 2 BOLT FOR O.D. PIPE

Part No.	Pipe Size	Box Qty.	Price
330-086-OD	2"	2	\$42.54
330-096-OD	2-1/2"	2	\$45.65
330-106-OD	3"	2	\$49.70
330-1056-OD	3-1/2"	1	\$53.91
330-116-OD	4"	1	\$55.72
330-126-OD	5"	1	\$60.57
330-136-OD	6"	1	\$63.60
330-1356-OD	7"	1	\$74.37
330-146-OD	8"	1	\$74.54
330-156-OD	10"	1	\$130.54
330-166-OD	12"	1	\$142.74

9" WIDE - 3 BOLT FOR IPS PIPE

Part No.	Pipe Size	Box Qty.	Price
330-029	3/8"	4	\$48.78
330-039	1/2"	4	\$48.78
330-049	3/4"	4	\$49.53
330-059	1"	4	\$54.58
330-069	1-1/4"	4	\$59.65
330-079	1-1/2"	3	\$67.49
330-089	2"	3	\$87.16
330-099	2-1/2"	1	\$92.66
330-109	3"	1	\$103.12
330-1059	3-1/2"	1	\$109.32
330-119	4"	1	\$111.37
330-129	5"	1	\$119.26
330-139	6"	1	\$125.10
330-1359	7"	1	\$141.51
330-149	8"	1	\$149.74
330-159	10"	1	\$242.35
330-169	12"	1	\$265.96



9" WIDE - 3 BOLT FOR O.D. PIPE

Part No.	Pipe Size	Box Qty.	Price
330-089-OD	2"	3	Call
330-099-OD	2-1/2"	1	Call
330-109-OD	3"	1	\$103.12
330-1059-OD	3-1/2"	1	Call
330-119-OD	4"	1	\$111.37
330-129-OD	5"	1	Call
330-139-OD	6"	1	\$125.10
330-1359-OD	7"	1	Call
330-149-OD	8"	1	\$149.74
330-159-OD	10"	1	Call
330-169-OD	12"	1	\$265.96

12" WIDE - 4 BOLT FOR IPS PIPE

Part No.	Pipe Size	Box Qty.	Price
330-0212	3/8"	4	\$65.04
330-0312	1/2"	4	\$65.04
330-0412	3/4"	4	\$66.05
330-0512	1"	4	\$72.77
330-0612	1-1/4"	4	\$79.54
330-0712	1-1/2"	3	\$94.10
330-0812	2"	3	\$116.22
330-0912	2-1/2"	2	\$122.48
330-1012	3"	2	\$137.48
330-10512	3-1/2"	1	\$144.71
330-1112	4"	1	\$147.39
330-1212	5"	1	\$159.03
330-1312	6"	1	\$166.76
330-13512	7"	1	\$188.70
330-1412	8"	1	\$198.63
330-1512	10"	1	\$323.12
330-1612	12"	1	\$354.60



12" WIDE - 4 BOLT FOR O.D. PIPE

Part No.	Pipe Size	Box Qty.	Price
330-0812-OD	2"	3	\$116.22
330-0912-OD	2-1/2"	2	Call
330-1012-OD	3"	2	Call
330-10512-OD	3-1/2"	1	Call
330-1112-OD	4"	1	\$147.39
330-1212-OD	5"	1	\$159.03
330-1312-OD	6"	1	\$166.76
330-13512-OD	7"	1	\$188.70
330-1412-OD	8"	1	\$198.63
330-1512-OD	10"	1	\$323.12
330-1612-OD	12"	1	\$354.60

PRIMING PUMPS



DP SERIES HAND DIAPHRAGM PRIMERS

Part No.	Description	Suction Pipe Size	Price
DP5	# 5 Hand Diaphragm Primer, Complete	2", 3", 4"	\$230.34
DP7	# 7 Hand Diaphragm Primer, Complete	4", 5", 6"	\$447.24
DP9	# 9 Hand Diaphragm Primer, Complete	6", 8" or Larger	\$638.14
TR-WR-9-30	Hand Diaphragm Primer, Complete	4", 5", 6", 8"	\$199.62

Note: Replacement parts also available.

EP SERIES EXHAUST PRIMERS

Primer Selection Chart					Part No.	Adapter Size	Price
EP60/90 Series					EP60/90/1	1" NPT Adapter	\$614.29
Engine Displacement Cubic In.					EP60/90/1.25	1-1/4" NPT Adapter	\$621.19
50	100	150			EP60/90/1.5	1-1/2" NPT Adapter	\$627.76
Suggested RPM					EP60/90/2	2" NPT Adapter	\$642.15
2500	2000	1800			EP60/90/2.5	2-1/2" NPT Adapter	\$691.02
					EP60/90/3	3" NPT Adapter	\$691.02
EP150/225 Series					EP150/225/1.25	1-1/4" NPT Adapter	\$629.26
Engine Displacement Cubic In.					EP150/225/1.5	1-1/2" NPT Adapter	\$642.50
150	200	250	300	400	EP150/225/2	2" NPT Adapter	\$701.21
Suggested RPM					EP150/225/2.5	2-1/2" NPT Adapter	\$723.22
2300	2000	1800	1700	1200	EP150/225/3	3" NPT Adapter	\$787.07
					EP150/225/3.5PE	3-1/2" Plain End	\$787.07
					EP150/225/4	4" NPT Adapter	\$912.36
EP250/300 Series					EP250/300/1.25	1-1/4" NPT Adapter	\$672.87
Engine Displacement Cubic In.					EP250/300/1.5	1-1/2" NPT Adapter	\$680.56
200	250	300	400	500	EP250/300/2	2" NPT Adapter	\$721.67
Suggested RPM					EP250/300/2.5	2-1/2" NPT Adapter	\$751.67
2300	2200	2000	1600	1200	EP250/300/3	3" NPT Adapter	\$837.60
					EP250/300/3.5PE	3-1/2" Plain End	\$837.60
					EP250/300/4	4" NPT Adapter	\$1,036.53
EP350/500 Series					EP350/500/1.5	1-1/2" NPT Adapter	\$705.00
Engine Displacement Cubic In.					EP350/500/2	2" NPT Adapter	\$703.39
					EP350/500/2.5	2-1/2" NPT Adapter	\$762.90
Suggested RPM					EP350/500/3	3" NPT Adapter	\$862.05
					EP350/500/3.5PE	3-1/2" Plain End	\$862.05
					EP350/500/4	4" NPT Adapter	\$1,064.09

Note: Exhaust Primers are not recommended for use on turbo engines.

HP SERIES HAND DIAPHRAGM PUMP

Part No.	Description	Inlet / Outlet Size	Price
HP700	Aluminum Diaphragm Pump	1-1/2"	\$869.79
HP900	Aluminum Diaphragm Pump	2"	\$1,004.22

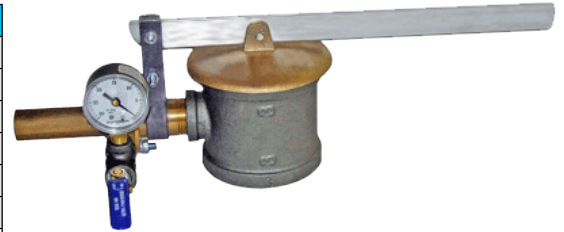

The Exhaust Primer is an air ejector adapted to an engine-driven pump. An adapter is attached to the exhaust stack to which the ejector is attached, and a lever-operated "exhaust valve" is provided by which the engine exhaust gases are momentarily diverted through the ejector during the priming period. "Momentarily" means 10 seconds to 2 minutes depending on the suction lift and length and size of the suction line. It operates on low engine exhaust pressure. When the exhaust valve is closed, the gases are directed through the ejector nozzle and air is drawn from the pump through the ejector suction.

All standard Protek Exhaust Primers are designed to operate at 12 to 14 PSI and thereby provide maximum lift and rapid priming.



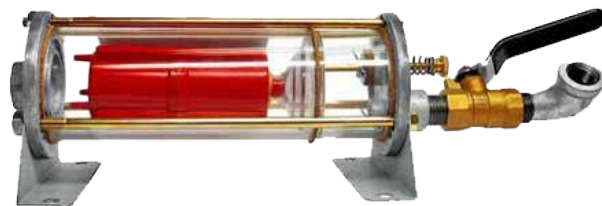

MP SERIES - MANIFOLD PRIMER

Part No.	Description	Price
MP1000	Manifold Primer	\$ 436.19

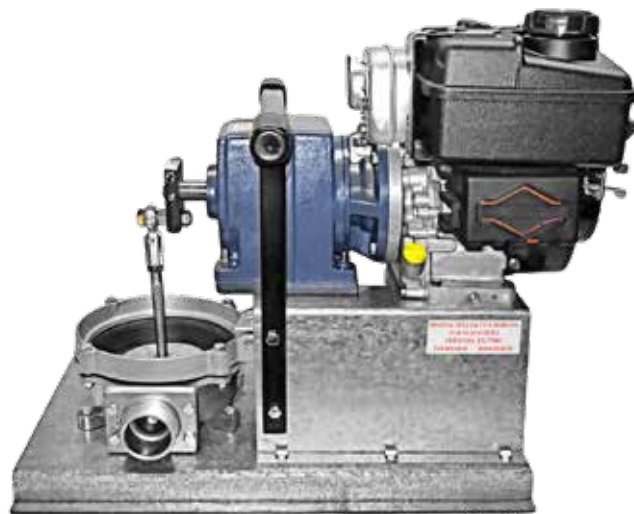
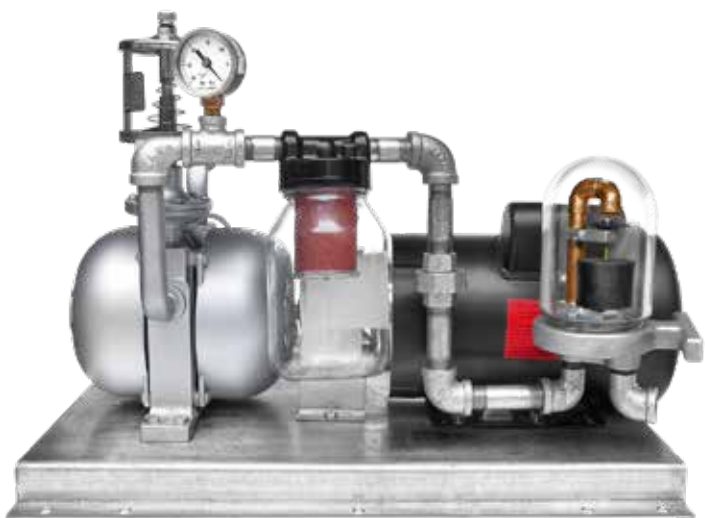

SPECIALTY DIAPHRAGM PUMPS & REPLACEMENT DIAPHRAGMS

Part No.	Description	Price
HP700G (HONDA)	Gas Diaphragm Pump *3PH	\$4,614.89
HP700G (B&S)	Gas Diaphragm Pump	\$4,254.88
HP700E	Electric Diaphragm Pump 1 HP	\$3,807.34
PP35AC-3PH	Power Primer 1/2HP 3 PH AC	\$8,539.42
PP35AC-1HP/460V	Power Primer 1HP 460V 3PH	\$4,668.62
PP35DC	Power Primer 12V DC	\$4,664.84
D0054	#5 Diaphragm	\$72.60
D0058	#7 Diaphragm	\$94.82
D0061	#9 Diaphragm	\$124.35
H0707C	#700 Diaphragm	\$111.38
H0707C-NEO	#700 Diaphragm, Neoprene	\$141.23
H0907C-FR	#900 Diaphragm, Fabric Reinforced	\$119.48

VERTICAL FOOT VALVES

SURE-FLO OD TUBING CONNECTION - ALUM.

Part No.	Size	Price
SFVV3	3"	\$333.00
SFVV4	4"	\$396.00
SFVV5	5"	\$609.00
SFVV6	6"	\$708.00
SFVV8	8"	\$996.00
SFVV10	10"	\$1,605.00



SURE-FLO FLANGED CONNECTION - ALUM.

Part No.	Size	Price
SFVV2CF	2"	\$349.50
SFVV3CF	3"	\$409.50
SFVV4CF	4"	\$564.00
SFVV5CF	5"	\$756.00
SFVV6CF	6"	\$895.50
SFVV8CF	8"	\$1,285.50
SFVV10CF	10"	\$1,803.00
SFVV12CF	12"	\$3,937.50



SURE-FLO FIPT CONNECTION - ALUMINUM

Part No.	Size	Price
SFVV2FP	2"	\$237.00
SFVV3FP	3"	\$315.00
SFVV4FP	4"	\$405.00
SFVV5FP	5"	\$751.50
SFVV6FP	6"	\$867.00
SFVV8FP	8"	\$1,137.00
SFVV10FP	10"	\$1,911.00



45° FOOT VALVES

SURE-FLO OD TUBING CONNECTION - ALUM.

Part No.	Size	Price
SFV2	2"	\$256.50
SFV3	3"	\$325.50
SFV4	4"	\$388.50
SFV5	5"	\$526.50
SFV6	6"	\$646.50
SFV8	8"	\$916.50
SFV10	10"	\$1,563.00



SURE-FLO FLANGED CONNECTION - ALUM.

Part No.	Size	Price
SFV2CF	2"	\$336.00
SFV3CF	3"	\$394.50
SFV4CF	4"	\$540.00
SFV5CF	5"	\$740.80
SFV6CF	6"	\$825.00
SFV8CF	8"	\$1,234.50
SFV10CF	10"	\$1,782.00



SURE-FLO FOOT VALVE SCREEN

Part No.	Size	Material	Price
SOV2	2"	Aluminum	\$8.10
SOV3	3"	Aluminum	\$15.90
SOV3SS	3"	Stainless Steel	\$68.25
SOV4	4"	Aluminum	\$25.58
SOV4SS	4"	Stainless Steel	\$103.28
SOV5	5"	Aluminum	\$32.10
SOV5SS	5"	Stainless Steel	\$140.10
SOV6	6"	Aluminum	\$40.80
SOV6SS	6"	Stainless Steel	\$178.80
SOV8	8"	Aluminum	\$79.35
SOV8SS	8"	Stainless Steel	\$344.63
SOV10	10"	Aluminum	\$115.65
SOV10SS	10"	Stainless Steel	\$518.70

SURE-FLO FIPT CONNECTION - ALUM.

Part No.	Size	Price
SFV2FP	2"	\$276.00
SFV3FP	3"	\$363.00
SFV4FP	4"	\$453.00
SFV5FP	5"	\$697.50
SFV6FP	6"	\$810.00
SFV8FP	8"	\$1,077.00
SFV10FP	10"	\$1,848.00



SUCTION FITTINGS

45° SUCTION ELBOW - ALUMINUM

Part No.	Size	Weight Lbs.	Price
SFE42	2"	3.5	\$145.50
SFE43	3"	4.5	\$199.50
SFE44	4"	6.0	\$226.50
SFE45	5"	7.0	\$322.50
SFE46	6"	9.0	\$351.00
SFE48	8"	12.0	\$504.00
SFE410	10"	17.0	\$891.00



90° SUCTION ELBOW - ALUMINUM

Part No.	Size	Weight Lbs.	Price
SFE92	2"	4.0	\$156.00
SFE93	3"	5.0	\$199.50
SFE94	4"	7.0	\$246.00
SFE95	5"	8.5	\$342.00
SFE96	6"	10.5	\$373.50
SFE98	8"	14.5	\$573.00
SFE910	10"	23.0	\$903.00



INTAKE COUPLERS - ALUMINUM

Part No.	Size	Weight Lbs.	Price
SFC2	2"	2.5	\$78.00
SFC3	3"	3.0	\$91.50
SFC4	4"	4.0	\$99.00
SFC5	5"	5.0	\$150.00
SFC6	6"	5.5	\$159.00
SFC8	8"	7.0	\$250.50
SFC10	10"	9.5	\$345.00



SUCTION ADAPTER - ALUMINUM

Part No.	Size	Weight Lbs.	Price
SA1503	1-1/2" x 3"	1.5	\$88.43
SA2003	2" x 3"	2.0	\$88.43
SA2503	2-1/2" x 3"	2.0	\$103.34
SA3003	3" x 3"	2.0	\$103.34
SA2004	2" x 4"	2.5	\$93.37
SA3004	3" x 4"	2.5	\$109.52
SA4004	4" x 4"	2.5	\$118.97
SA3005	3" x 5"	3.0	\$250.16
SA4005	4" x 5"	3.0	\$156.86
SA5005	5" x 5"	3.0	\$168.11
SA3006	3" x 6"	4.0	\$151.54
SA4006	4" x 6"	4.0	\$165.01
SA5006	5" x 6"	4.0	\$178.50
SA6006	6" x 6"	4.0	\$202.09
SA5007	5" x 7"	4.5	\$207.77
SA6007	6" x 7"	4.5	\$225.19
SA7007	7" x 7"	4.5	\$279.61
SA5008	5" x 8"	5.0	\$233.04
SA6008	6" x 8"	5.0	\$250.39
SA7008	7" x 8"	5.25	\$304.98
SA8008	8" x 8"	5.25	\$304.98



SUCTION ADAPTER - STEEL

Part No.	Size	Weight Lbs.	Price
SSA3003	3" x 3"	4.0	\$102.48
SSA3004	3" x 4"	4.0	\$108.59
SSA4004	4" x 4"	5.0	\$117.95
SSA4005	4" x 5"	7.0	\$150.98
SSA4006	4" x 6"	8.0	\$163.62
SSA4007	4" x 7"	10.0	\$171.30
SSA5005	5" x 5"	8.0	\$167.34
SSA5006	5" x 6"	9.0	\$183.06
SSA5007	5" x 7"	10.0	\$209.96
SSA5008	5" x 8"	12.0	\$235.86
SSA6006	6" x 6"	13.0	\$200.40
SSA6007	6" x 7"	14.0	\$223.25
SSA6008	6" x 8"	16.0	\$253.06
SSA8008	8" x 8"	17.0	\$302.36

INTAKE STRAINERS - THREADED CONNECTION

ROUND HOLE STRAINER (THREADED)

Part No.	FIPT Size	Weight Lbs.	Screen Open Area	Price
RHS150	1-1/2"	1.5	19 Sq. In.	\$16.02
RHS200	2"	1.9	26 Sq. In.	\$18.56
RHS250	2-1/2"	2	26 Sq. In.	\$19.91
RHS300	3"	3	40 Sq. In.	\$27.18
RHS400	4"	3	42 Sq. In.	\$30.54
RHS600	6"	11	144 Sq. In.	\$89.47
RHS800	8"	22	219 Sq. In.	\$153.38
RHS100	10"	47	435 Sq. In.	\$556.88

Note: 1-1/2" - 4" is 3/8" hole size / 6" - 12" is 1" hole size / Zinc plated steel construction



BASIC STRAINER (THREADED)*

Part No.	FIPT Size	Weight Lbs.	Screen Open Area	Price
SFS2P	2"	2.0	15 Sq. In.	\$93.00
SFS25P	2-1/2"	2.0	23 Sq. In.	Call
SFS3P	3"	2.5	38 Sq. In.	\$105.00
SFS4P	4"	6.5	97 Sq. In.	\$169.50
SFS4P With Slide				\$202.50



J STRAINER - SINGLE SCREEN WITHOUT SLIDE (THREADED)*

Part No.	FIPT Size	Weight Lbs.	Screen Open Area	Price
SFSJ4FP	4"	17.0	314 Sq. In.	\$588.00
SFSJ5FP	5"	17.5	314 Sq. In.	\$618.00
SFSJ6FP	6"	17.5	314 Sq. In.	\$636.00
SFSJ8FP	8"	18.0	314 Sq. In.	\$681.00
SFSJ10FP	10"	21.5	314 Sq. In.	\$765.00
With Slide Add				\$90.00



JD STRAINER - DOUBLE SCREEN WITHOUT SLIDE (THREADED)*

Part No.	FIPT Size	Weight Lbs.	Screen Open Area	Price
SFSJ4FP-D	4"	24.5	628 Sq. In.	\$870.00
SFSJ5FP-D	5"	25.0	628 Sq. In.	\$894.00
SFSJ6FP-D	6"	25.0	628 Sq. In.	\$916.50
SFSJ8FP-D	8"	25.5	628 Sq. In.	\$963.00
SFSJ10FP-D	10"	29.0	628 Sq. In.	\$1,047.00
With Slide Add				\$177.00

* Standard 1/4" hole size - Aluminum construction

INTAKE STRAINERS - COMPANION FLANGE CONNECTION

Matches the bolt pattern of a standard 125 lb cast iron companion flange or a Schedule 80 PVC flange.
Standard 1/4" hole size - Aluminum construction

BASIC STRAINER WITH SLIDE (C.F.C)

Part No.	Flange Size	Weight Lbs.	Screen Open Area	Price
SFSF2	2"	3.5	44 Sq. In.	\$133.50
SFSF3	3"	5.5	54 Sq. In.	\$198.00
SFSF4	4"	6.5	81 Sq. In.	\$220.50
SFSF6	6"	9.0	160 Sq. In.	\$288.00
SFSF8	8"	16.0	250 Sq. In.	\$228.00



J STRAINER - SINGLE SCREEN (C.F.C)

Part No.	Flange Size	Weight Lbs.	Screen Open Area	Price
SFSFJ4	4"	16.5	314 Sq. In.	\$510.00
SFSFJ6	6"	15.5	314 Sq. In.	\$510.00



JD STRAINER - DOUBLE SCREEN (C.F.C)

Part No.	Flange Size	Weight Lbs.	Screen Open Area	Price
SFSFJ4-D	4"	24.0	628 Sq. In.	\$787.50
SFSFJ6-D	6"	22.5	628 Sq. In.	\$787.50



XL STRAINER (C.F.C)

Part No.	Flange Size	Weight Lbs.	Screen Open Area	Price
SFSF10	10"	50.5	972 Sq. In.	\$1,228.50
SFSF12	12"	54.5	972 Sq. In.	\$1,228.50

INTAKE STRAINERS - OD TUBING CONNECTION

Standard 1/4" hole size - Aluminum construction

BASIC STRAINER WITH SLIDE (OD)

Part No.	OD Tubing Size	Weight Lbs.	Screen Open Area	Price
SFS2	2"	1.5	15 Sq. In.	\$58.50
SFS3	3"	2.0	24 Sq. In.	\$70.50
SFS4	4"	3.5	42 Sq. In.	\$94.50
SFS5	5"	4.5	66 Sq. In.	\$136.50
SFS6	6"	6.0	97 Sq. In.	\$163.50
SFS8	8"	11.0	192 Sq. In.	\$277.50
SFS10	10"	15.0	332 Sq. In.	\$369.00



J STRAINER - SINGLE SCREEN WITH SLIDE (OD)

Part No.	OD Tubing Size	Weight Lbs.	Screen Open Area	Price
SFSJ4	4"	14.5	314 Sq. In.	\$576.00
SFSJ5	5"	14.5	314 Sq. In.	\$576.00
SFSJ6	6"	14.5	314 Sq. In.	\$576.00
SFSJ8	8"	14.0	314 Sq. In.	\$576.00
SFSJ10	10"	13.5	314 Sq. In.	\$576.00
Price if Ordered Without Slide				\$486.00



JD STRAINER - DOUBLE SCREEN WITH SLIDE (OD)

Part No.	OD Tubing Size	Weight Lbs.	Screen Open Area	Price
SFSJ4-D	4"	21.5	628 Sq. In.	\$940.50
SFSJ5-D	5"	21.5	628 Sq. In.	\$940.50
SFSJ6-D	6"	21.5	628 Sq. In.	\$940.50
SFSJ8-D	8"	21.0	628 Sq. In.	\$940.50
SFSJ10-D	10"	21.0	628 Sq. In.	\$940.50
Price if Ordered Without Slide				\$763.50



XL STRAINER WITH SLIDE (OD)

Part No.	OD Tubing Size	Weight Lbs.	Screen Open Area	Price
SFS6XL	6"	52.0	972 Sq. In.	\$1,431.00
SFS8XL	8"	51.5	972 Sq. In.	\$1,431.00
SFS10XL	10"	51.0	972 Sq. In.	\$1,431.00
SFS12XL	12"	53.5	972 Sq. In.	\$1,431.00
Price if Ordered Without Slide (Excludes SFS12XL)				\$1,204.50



HORIZONTAL STRAINER WITHOUT SLIDE (OD)

Part No.	OD Tubing Size	Weight Lbs.	Screen Open Area	Price
SFSH4	4"	20.5	470 Sq. In.	\$816.00
SFSH6	6"	22.0	470 Sq. In.	\$832.50
SFSH8	8"	23.5	470 Sq. In.	\$879.00

Available with slide, please call for pricing.

INTAKE STRAINERS - IPS PIPE CONNECTION

Standard 1/4" hole size - Aluminum construction

BASIC STRAINER (IPS)

Part No.	OD Tubing Size	Weight Lbs.	Screen Open Area	Price
SPVC4	4"	4.0	61 Sq. In.	\$151.50
SPVC6	6"	5.5	97 Sq. In.	\$228.00
SPVC8	8"	8.0	190 Sq. In.	\$303.00
SPVC10	10"	12.0	314 Sq. In.	\$487.50



J STRAINER - SINGLE SCREEN (IPS)

Part No.	OD Tubing Size	Weight Lbs.	Screen Open Area	Price
SPVCJ6	6"	19.5	314 Sq. In.	\$513.00
SPVCJ8	8"	19.0	314 Sq. In.	\$513.00



JD STRAINER - DOUBLE SCREEN (IPS)

Part No.	OD Tubing Size	Weight Lbs.	Screen Open Area	Price
SPVCJ6-D	6"	27.0	628 Sq. In.	\$784.50
SPVCJ8-D	8"	27.0	628 Sq. In.	\$784.50



XL STRAINER (IPS)

Part No.	OD Tubing Size	Weight Lbs.	Screen Open Area	Price
SPVC12	12"	53.5	972 Sq. In.	\$1,204.50
SPVC15	15"	46.0	972 Sq. In.	\$1,204.50
SPVC16	16"	45.5	972 Sq. In.	\$1,204.50

Opening Size: SPVC12: 12.875" SPVC15: 15.375" SPVC16: 16.25"



SELF CLEANING PUMP SUCTION SCREEN

The pump suction screen is attached to the end of the pump suction line by way of a standard flange. All water pulled in must go through the screen before entering the intake pipe. The 10, 18 or 30 mesh heavy stainless steel screen stops trash and debris from entering & creating problems associated with plugging. A small sidestream pump discharge return line drives two spray bars that continually rotate jet streams at the screen & blasts debris away from the screen. The unit is manufactured with heavy galvanized steel construction & a removable exterior basket for servicing.

Part No.	10/18 Mesh Max. Flow GPM	30 Mesh Max. Flow GPM	Flanged Inlet Size	Minimum Operating PSI	Return Flow Required GPM	Weight Lbs.	Price
CW200	325	225	4"	35	20	58	Call
CW400	550	400	6"	40	20	62	Call
CW600	750	525	8"	40	20	102	Call
CW800	950	700	10"	45	20	115	Call
CW1000	1350	950	10"	50	24	123	Call
CW1400	1550	1075	12"	55	24	131	Call
CW1700	1800	1250	12"	55	24	148	Call
CW2000	2100	1450	14"	60	24	160	Call
CW2400	2600	1800	16"	65	28	223	Call

PVC INSERT FITTINGS

For use with polyethylene pipe, rubber discharge hose or PVC layflat discharge hose. Additional fittings available upon request. Please call for special fitting requirements.

FITTING DIMENSIONS					
Nominal Size	Average Barb	Nominal Size	Average Barb	Nominal Size	Average Barb
1/2"	.65"	2" TS	2.01"	6"	6.09"
3/4"	.85"	2-1/2"	2.50"	6" TS	6.02"
1"	1.08"	3"	3.11"	8"	8.15"
1-1/4"	1.41"	3" TS	3.01"	8" TS	8.02"
1-1/2"	1.65"	4"	4.07"	10"	10.15"
2"	2.11"	4" TS	4.01"	10" TS	10.02"

Note: TS is True Size for Layflat

TEE (INS X INS X INS)



Part No.	Size-In.	Price
1401-005	1/2	\$1.40
1401-007	3/4	\$1.51
1401-010	1	\$1.97
1401-012	1-1/4	\$3.07
1401-015	1-1/2	\$3.49
1401-020	2	\$6.89
T-02.5	2-1/2	\$48.76
T-03	3	\$29.08
T-04	4	\$66.60
T-06	6	\$208.71
T-08	8	\$355.24
T-10	10	\$683.10

TEE (INS X INS X FIPT)



Part No.	Size-In.	Price
1402-005	1/2	\$1.51
1402-007	3/4	\$2.28
1402-010	1	\$2.68
1402-012	1-1/4	\$3.95
1402-015	1-1/2	\$6.85
1402-020	2	\$8.50

90° ELL (INS X INS)



Part No.	Size-In.	Price
1406-005	1/2	\$1.28
1406-007	3/4	\$1.56
1406-010	1	\$1.73
1406-012	1-1/4	\$1.93
1406-015	1-1/2	\$2.28
1406-020	2	\$3.18
1406-025	2-1/2	\$14.36
L-03	3	\$22.25
L-04	4	\$42.71
L-06	6	\$137.33
L-08	8	\$260.31
L-10	10	Call

REDUCING TEE (INS X INS FIPT)



Part No.	Size-In.	Price
1402-094	3/4 x 1/2 x 1/2	\$2.48
1402-101	3/4 x 3/4 x 1/2	\$1.90
1402-124	1 x 3/4 x 1/2	\$3.09
1402-125	1 x 3/4 x 3/4	\$3.68
1402-130	1 x 1 x 1/2	\$2.48
1402-131	1 x 1 x 3/4	\$2.48
1402-156	1-1/4 x 1 x 1/2	\$4.56
1402-157	1-1/4 x 1 x 3/4	\$5.34
1402-166	1-1/4 x 1-1/4 x 1/2	\$3.39
1402-167	1-1/4 x 1-1/4 x 3/4	\$3.74
1402-168	1-1/4 x 1-1/4 x 1	\$3.95
1402-199	1-1/2 x 1-1/4 x 1/2	\$7.19
1402-201	1-1/2 x 1-1/4 x 3/4	\$8.01
1402-202	1-1/2 x 1-1/4 x 1	\$9.17
1402-209	1-1/2 x 1-1/2 x 1/2	\$5.20
1402-210	1-1/2 x 1-1/2 x 3/4	\$6.16
1402-211	1-1/2 x 1-1/2 x 1	\$6.16
1402-212	1-1/2 x 1-1/2 x 1-1/4	\$6.32
1402-247	2 x 2 x 1/2	\$6.98
1402-248	2 x 2 x 3/4	\$7.38
1402-249	2 x 2 x 1	\$8.11
1402-251	2 x 2 x 1-1/2	\$8.50

REDUCING TEE (INS X INS X INS)



Part No.	Size-In.	Price
1401-074	1/2 x 1/2 x 3/4	\$3.77
1401-094	3/4 x 1/2 x 1/2	\$1.90
1401-101	3/4 x 3/4 x 1/2	\$1.71
1401-102	3/4 x 3/4 x 1	\$4.35
1401-124	1 x 3/4 x 1/2	\$2.75
1401-125	1 x 3/4 x 3/4	\$3.27
1401-130	1 x 1 x 1/2	\$2.01
1401-131	1 x 1 x 3/4	\$2.03
1401-132	1 x 1 x 1-1/4	\$6.07
1401-156	1-1/4 x 1 x 1/2	\$3.75
1401-157	1-1/4 x 1 x 3/4	\$3.75
1401-158	1-1/4 x 1 x 1	\$3.75
1401-166	1-1/4 x 1-1/4 x 1/2	\$2.64
1401-167	1-1/4 x 1-1/4 x 3/4	\$2.64
1401-168	1-1/4 x 1-1/4 x 1	\$2.64
1401-201	1-1/2 x 1-1/4 x 3/4	\$4.74
1401-202	1-1/2 x 1-1/4 x 1	\$4.74
1401-203	1-1/2 x 1-1/4 x 1-1/4	\$4.74
1401-209	1-1/2 x 1-1/2 x 1/2	\$4.60
1401-210	1-1/2 x 1-1/2 x 3/4	\$4.60
1401-211	1-1/2 x 1-1/2 x 1	\$4.60
1401-212	1-1/2 x 1-1/2 x 1-1/4	\$4.60
1401-241	2 x 1-1/2 x 1-1/2	\$6.07
1401-247	2 x 2 x 1/2	\$6.55
1401-248	2 x 2 x 3/4	\$6.55
1401-249	2 x 2 x 1	\$6.55
1401-250	2 x 2 x 1-1/4	\$6.85
1401-251	2 x 2 x 1-1/2	\$7.05
1401-335	3 x 3 x 1	\$73.20
1401-338	3 x 3 x 2	\$80.67

TEE (INS X INS MIPT)



Part No.	Size-In.	Price
1403-005	1/2	\$1.93
1403-007	3/4	\$2.64
1403-010	1	\$3.39
1403-012	1-1/4	\$4.41
1403-015	1-1/2	\$4.92
1403-020	2	\$7.66

REDUCING TEE

1403-130	1 x 1 x 1/2	\$3.23
1403-131	1 x 1 x 3/4	\$3.23

TEE (INS X INS X SOCKET)



Part No.	Size-In.	Price
1404-010	1	\$2.68
1404-102	3/4 x 3/4 x 1	\$4.35

90° REDUCING ELL (INS X INS)



Part No.	Size-In.	Price
1406-101	3/4 x 1/2	\$1.48
1406-131	1 x 3/4	\$1.81
1406-168	1-1/4 x 1	\$2.68
1406-212	1-1/2 x 1-1/4	\$3.18
1406-251	2 x 1-1/2	\$3.50

90° ELL (INS X FIPT)



Part No.	Size-In.	Price
1407-005	1/2	\$1.44
1407-007	3/4	\$1.56
1407-010	1	\$2.01
1407-012	1-1/4	\$2.98
1407-015	1-1/2	\$3.39
1407-020	2	\$5.71

90° REDUCING ELL (INS X FIPT)



Part No.	Size-In.	Price
1407-074	1/2 x 3/4	\$1.48
1407-101	3/4 x 1/2	\$1.48
1407-130	1 x 1/2	\$1.56
1407-131	1 x 3/4	\$1.81
1407-166	1-1/4 x 1/2	\$2.68
1407-167	1-1/4 x 3/4	\$2.68
1407-168	1-1/4 x 1	\$2.68
1407-211	1-1/2 x 1	\$3.06
1407-212	1-1/2 x 1-1/4	\$3.32
1407-251	2 x 1-1/2	\$5.42

Intro 1 - Pvcot 2 - Valves 3 - Surface 4 - IPS Epoxy / Galv 5 - Suction Fittings 6 - PVC Fittings 7 - Sprinklers 8 - Malleable 9 - Hose 10 - Injectors / Filters 11 - Low Volume Formulas / TC

PVC INSERT FITTINGS

90° ELL (INS X MIPT)



Part No.	Size-In.	Price
1413-005	1/2	\$1.60
1413-007	3/4	\$2.23
1413-010	1	\$2.92
1413-012	1-1/4	\$3.88
1413-015	1-1/2	\$5.15
1413-020	2	\$8.13

90° REDUCING ELL

1413-101	3/4 x 1/2	\$2.78
1413-130	1 x 1/2	\$3.16
1413-131	1 x 3/4	\$3.96

SIDE OUTLET ELL (INS X INS X FIPT)



Part No.	Size-In.	Price
1414-101	3/4 x 3/4 x 1/2	\$3.68
1414-130	1 x 1 x 1/2	\$3.96
1414-131	1 x 1 x 3/4	\$3.96

SIDE OUTLET TEE (INS X INS X INS X FIPT)



Part No.	Size-In.	Price
1416-007	3/4 x 3/4 x 3/4 x 3/4	\$4.75
1416-101	3/4 x 3/4 x 3/4 x 1/2	\$4.75
1416-130	1 x 1 x 1 x 1/2	\$5.05
1416-131	1 x 1 x 1 x 3/4	\$5.05

CROSS (INS X INS X INS X INS)



Part No.	Size-In.	Price
1420-007	3/4	\$3.66
1420-010	1	\$4.55

COUPLING (INS X INS)



Part No.	Size-In.	Price
1429-005	1/2	\$0.65
1429-007	3/4	\$0.78
1429-010	1	\$0.82
1429-012	1-1/4	\$1.21
1429-015	1-1/2	\$1.43
1429-020	2	\$2.71
C-02TS	2	Call
1429-025	2-1/2	\$7.02
1429-030	3	\$11.92
C-03TS	3	Call
1429-040	4	\$16.22
C-04TS	4	Call
C-05TS	5	Call
C-06	6	\$38.20
C-06TS	6	Call
C-08	8	\$85.34
C-08TS	8	Call
C-10	10	Call
C-10TS	10	Call

REDUCING COUPLING (INS X INS)



Part No.	Size-In.	Price
1429-101	3/4 x 1/2	\$1.06
1429-130	1 x 1/2	\$1.46
1429-131	1 x 3/4	\$1.09
1429-167	1-1/4 x 3/4	\$2.24
1429-168	1-1/4 x 1	\$1.73
1429-210	1-1/2 x 3/4	\$2.71
1429-211	1-1/2 x 1	\$2.61
1429-212	1-1/2 x 1-1/4	\$2.03
1429-249	2 x 1	\$3.68
1429-250	2 x 1-1/4	\$3.43
1429-251	2 x 1-1/2	\$3.26
R-25X2	2-1/2 x 2	\$22.17
1429-338	3 x 2	\$26.37
R-3X25	3 x 2-1/2	\$26.37
R-4X2	4 x 2	\$43.20
R-4X3	4 x 3	\$43.20
R-6X4	6 x 4	\$84.92
R-6X5	6 x 5	\$89.16
R-8X4	8 x 4	Call
R-8X6	8 x 6	\$198.22

FEMALE ADAPTER (FIPT X INS)



Part No.	Size-In.	Price
1435-005	1/2	\$2.84
1435-007	3/4	\$3.09
1435-010	1	\$3.43
1435-012	1-1/4	\$4.21
1435-015	1-1/2	\$5.34
1435-020	2	\$6.79
FA-025	2-1/2	\$16.86
FA-03	3	\$22.08
FA-04	4	\$26.90
FA-06	6	\$99.76
FA-08	8	Call

MALE ADAPTER (MIPT X INS)



Part No.	Size-In.	Price
1436-005	1/2	\$0.64
1436-007	3/4	\$0.78
1436-010	1	\$0.80
1436-012	1-1/4	\$1.28
1436-015	1-1/2	\$1.43
1436-020	2	\$2.74
1436-025	2-1/2	\$11.26
1436-030	3	\$13.00
1436-040	4	\$18.07
MA-06	6	\$85.88
MA-08	8	\$136.69
MA-10	10	Call

REDUCING MALE ADAPTER

1436-074	1/2 x 3/4	\$2.03
1436-075	1/2 x 1	\$2.11
1436-101	3/4 x 1/2	\$1.83
1436-102	3/4 x 1	\$2.11
1436-131	1 x 3/4	\$1.90
1436-132	1 x 1-1/4	\$2.55
1436-133	1 x 1-1/2	\$3.85
1436-167	1-1/4 x 3/4	\$2.24
1436-168	1-1/4 x 1	\$2.39
1436-169	1-1/4 x 1-1/2	\$3.85
1436-211	1-1/2 x 1	\$2.92
1436-212	1-1/2 x 1-1/4	\$2.92
1436-213	1-1/2 x 2	\$4.94
1436-251	2 x 1-1/2	\$4.90

HOSE ADAPTER (MHT X INS)



Part No.	Size-In.	Price
1436-007MHT	3/4	\$1.91

REDUCING HOSE ADAPTER

1436-101MHT	3/4 x 1/2	\$1.81
1436-102MHT	3/4 x 1	\$2.08

ADAPTER (INS X SPIG)



Part No.	Size-In.	Price
460-005	1/2	\$1.11
460-007	3/4	\$1.46
460-010	1	\$1.52
460-012	1-1/4	\$1.58
460-015	1-1/2	\$1.69
460-020	2	\$2.81
ISP-2TS	2	Call
ISP-2.5	2-1/2	\$8.76
460-030	3	\$9.49
ISP-3TS	3	Call
460-040	4	\$10.92
ISP-4TS	4	Call
ISP-6	6	\$52.87
ISP-6TS	6	Call
ISP-8	8	\$107.96
ISP-8TS	8	Call
ISP-10	10	Call

ADAPTER (INS X SLIP)



Part No.	Size-In.	Price
474-005	1/2	\$1.01
474-007	3/4	\$1.21
474-010	1	\$1.29
474-012	1-1/4	\$2.04
474-015	1-1/2	\$2.26
474-020	2	\$4.19
474-030	3	\$12.50
IXS-3TS	3	Call
474-040	4	\$14.29
IXS-4TS	4	Call
IXS-6	6	\$68.02
IXS-6TS	6	Call
IXS-8	8	\$126.13
IXS-8TS	8	Call
IXS-10	10	Call

PLUG (INS)



Part No.	Size-In.	Price
1449-005	1/2	\$1.16
1449-007	3/4	\$1.21
1449-010	1	\$1.63
1449-012	1-1/4	\$2.07
1449-015	1-1/2	\$2.26
1449-020	2	\$3.97
PL025	2-1/2	\$17.06
PL03	3	\$17.17
PL04	4	\$18.40
PL06	6	\$82.96
PL08	8	Call

SCHEDULE 40 PVC FITTINGS

TEE

(soc x soc x soc)



Part No.	Size-In.	Box	Price
401-003	3/8	50	\$1.22
401-005	1/2	50	\$0.39
401-007	3/4	50	\$0.45
401-010	1	50	\$0.85
401-012	1-1/4	25	\$1.32
401-015	1-1/2	25	\$1.60
401-020	2	25	\$2.33
401-025	2-1/2	10	\$7.69
401-030	3	10	\$10.11
401-040	4	6	\$18.29
401-050	5	5	\$44.18
401-060	6	4	\$61.57
401-080	8	2	\$142.79
401-100	10	1	\$1,123.67
401-120	12	1	\$1,660.28

REDUCING TEE

(soc x soc x soc)



Part No.	Size-In.	Box	Price
401-053	3/8 x 3/8 x 1/2	50	\$2.71
401-074	1/2 x 1/2 x 3/4	50	\$0.84
401-075	1/2 x 1/2 x 1	50	\$1.56
401-094	3/4 x 1/2 x 1/2	50	\$0.76
401-095	3/4 x 1/2 x 3/4	50	\$0.76
401-101	3/4 x 3/4 x 1/2	50	\$0.52
401-102	3/4 x 3/4 x 1	50	\$1.50
401-122	1 x 1/2 x 1	50	\$1.50
401-124	1 x 3/4 x 1/2	50	\$1.50
401-125	1 x 3/4 x 3/4	50	\$1.50
401-126	1 x 3/4 x 1	50	\$1.50
401-130	1 x 1 x 1/2	50	\$0.89
401-131	1 x 1 x 3/4	50	\$0.97
401-132	1 x 1 x 1-1/4	25	\$2.00
401-133	1 x 1 x 1-1/2	25	\$2.58
401-134	1 x 1 x 2	25	\$3.63
401-156	1-1/4 x 1 x 1/2	25	\$2.04
401-157	1-1/4 x 1 x 3/4	25	\$2.04
401-158	1-1/4 x 1 x 1	25	\$2.04
401-166	1-1/4 x 1-1/4 x 1/2	25	\$1.45
401-167	1-1/4 x 1-1/4 x 3/4	25	\$1.45
401-168	1-1/4 x 1-1/4 x 1	25	\$1.45
401-169	1-1/4 x 1-1/4 x 1-1/2	25	\$2.64
401-170	1-1/4 x 1-1/4 x 2	25	\$3.63
401-199	1-1/2 x 1-1/4 x 1/2	25	\$2.54
401-201	1-1/2 x 1-1/4 x 3/4	25	\$2.54
401-202	1-1/2 x 1-1/4 x 1	25	\$2.54
401-209	1-1/2 x 1-1/2 x 1/2	25	\$2.54
401-210	1-1/2 x 1-1/2 x 3/4	25	\$2.54
401-211	1-1/2 x 1-1/2 x 1	25	\$2.54
401-212	1-1/2 x 1-1/2 x 1-1/4	25	\$2.54
401-213	1-1/2 x 1-1/2 x 2	25	\$3.63
401-214	1-1/2 x 1-1/2 x 2-1/2	25	\$8.00
401-238	2 x 1-1/2 x 3/4	10	\$3.63
401-239	2 x 1-1/2 x 1	10	\$3.63
401-241	2 x 1-1/2 x 1-1/2	10	\$3.63
401-247	2 x 2 x 1/2	10	\$2.50
401-248	2 x 2 x 3/4	10	\$2.50
401-249	2 x 2 x 1	10	\$2.50
401-250	2 x 2 x 1-1/4	10	\$2.50
401-251	2 x 2 x 1-1/2	10	\$2.50
401-253	2 x 2 x 3	10	\$16.79
401-254	2 x 2 x 4	6	\$33.23
401-287	2-1/2 x 2-1/2 x 1/2	10	\$7.68
401-288	2-1/2 x 2-1/2 x 3/4	10	\$7.68
401-289	2-1/2 x 2-1/2 x 1	10	\$7.68
401-290	2-1/2 x 2-1/2 x 1-1/4	10	\$7.68
401-291	2-1/2 x 2-1/2 x 1-1/2	10	\$7.68
401-292	2-1/2 x 2-1/2 x 2	10	\$7.68

REDUCING TEE - Continued

(soc x soc x soc)



Part No.	Size-In.	Box	Price
401-293	2-1/2 x 2-1/2 x 3	10	\$17.16
401-294	2-1/2 x 2-1/2 x 4	6	\$33.23
401-333	3 x 3 x 1/2	10	\$11.00
401-334	3 x 3 x 3/4	10	\$11.00
401-335	3 x 3 x 1	10	\$11.00
401-336	3 x 3 x 1-1/4	10	\$11.00
401-337	3 x 3 x 1-1/2	10	\$11.00
401-338	3 x 3 x 2	6	\$10.98
401-339	3 x 3 x 2-1/2	6	\$13.74
401-342	3 x 3 x 4	6	\$18.90
401-344	3 x 3 x 6	4	\$98.52
401-415	4 x 4 x 1/2	6	\$19.00
401-416	4 x 4 x 3/4	6	\$18.29
401-417	4 x 4 x 1	6	\$18.29
401-418	4 x 4 x 1-1/4	10	\$18.29
401-419	4 x 4 x 1-1/2	10	\$18.29
401-420	4 x 4 x 2	10	\$18.29
401-421	4 x 4 x 2-1/2	6	\$21.20
401-422	4 x 4 x 3	6	\$18.29
401-426	4 x 4 x 6	4	\$98.52
401-428	4 x 4 x 8	2	\$271.94
401-486	5 x 5 x 2	5	\$42.89
401-487	5 x 5 x 2-1/2	4	\$47.19
401-488	5 x 5 x 3	4	\$42.89
401-490	5 x 5 x 4	3	\$42.89
401-492	5 x 5 x 6	4	\$100.61
401-526	6 x 6 x 1-1/4	4	\$62.97
401-527	6 x 6 x 1-1/2	5	\$62.97
401-528	6 x 6 x 2	3	\$61.57
401-529	6 x 6 x 2-1/2	5	\$66.24
401-530	6 x 6 x 3	5	\$61.57
401-532	6 x 6 x 4	2	\$61.57
401-533	6 x 6 x 5	4	\$81.72
401-535	6 x 6 x 8	1	\$271.94
401-537	6 x 6 x 10	1	Call
401-578	8 x 8 x 2	2	\$149.12
401-579	8 x 8 x 2-1/2	4	\$149.12
401-580	8 x 8 x 3	4	\$142.79
401-582	8 x 8 x 4	2	\$142.79
401-583	8 x 8 x 5	2	\$164.60
401-585	8 x 8 x 6	2	\$142.79
401-589	8 x 8 x 10	1	\$1,952.07
401-621	10 x 10 x 2	1	Call
401-623	10 x 10 x 3	1	\$1,006.97
401-624	10 x 10 x 4	1	\$1,006.97
401-625	10 x 10 x 5	1	Call
401-626	10 x 10 x 6	1	\$962.96
401-628	10 x 10 x 8	1	\$12,977.78
401-632	10 x 10 x 12	1	Call
401-664	12 x 12 x 4	1	Call
401-666	12 x 12 x 6	1	\$1,576.20
401-668	12 x 12 x 8	1	\$1,391.29
401-670	12 x 12 x 10	1	\$2,167.88

TEE

(soc x soc x fipt)



Part No.	Size-In.	Box	Price
402-003	3/8	50	\$1.23
402-005	1/2	50	\$0.52
402-007	3/4	50	\$0.81
402-010	1	50	\$1.50
402-012	1-1/4	25	\$2.38
402-015	1-1/2	25	\$3.10
402-020	2	10	\$3.93
402-025	2-1/2	10	\$11.94
402-030	3	10	\$15.22
402-040	4	6	\$23.26

REDUCING TEE

(soc x soc x fipt)



Part No.	Size-In.	Box	Price
402-071	1/2 x 1/2 x 1/8	50	\$1.12
402-072	1/2 x 1/2 x 1/4	50	\$1.12
402-074	1/2 x 1/2 x 3/4	50	\$1.12
402-094	3/4 x 1/2 x 1/2	50	\$0.78
402-095	3/4 x 1/2 x 3/4	50	\$0.78
402-101	3/4 x 3/4 x 1/2	50	\$0.69
402-124	1 x 3/4 x 1/2	50	\$1.50
402-125	1 x 3/4 x 3/4	50	\$1.50
402-130	1 x 1 x 1/2	50	\$1.04
402-131	1 x 1 x 3/4	50	\$1.50
402-156	1-1/4 x 1 x 1/2	25	\$2.38
402-157	1-1/4 x 1 x 3/4	25	\$2.38
402-158	1-1/4 x 1 x 1	25	\$2.38
402-166	1-1/4 x 1-1/4 x 1/2	25	\$2.50
402-167	1-1/4 x 1-1/4 x 3/4	25	\$2.50
402-168	1-1/4 x 1-1/4 x 1	25	\$2.50
402-199	1-1/2 x 1-1/4 x 1/2	25	\$3.10
402-201	1-1/2 x 1-1/4 x 3/4	25	\$3.10
402-202	1-1/2 x 1-1/4 x 1	25	\$3.10
402-209	1-1/2 x 1-1/2 x 1/2	25	\$3.10
402-210	1-1/2 x 1-1/2 x 3/4	25	\$3.10
402-211	1-1/2 x 1-1/2 x 1	25	\$3.10
402-212	1-1/2 x 1-1/2 x 1-1/4	25	\$3.10
402-238	2 x 1-1/2 x 3/4	10	\$3.90
402-239	2 x 1-1/2 x 1	10	\$3.90
402-247	2 x 2 x 1/2	10	\$3.90
402-248	2 x 2 x 3/4	10	\$3.90
402-249	2 x 2 x 1	10	\$3.90
402-250	2 x 2 x 1-1/4	10	\$3.90
402-251	2 x 2 x 1-1/2	10	\$3.90
402-287	2-1/2 x 2-1/2 x 1/2	10	\$8.43
402-288	2-1/2 x 2-1/2 x 3/4	10	\$8.43
402-289	2-1/2 x 2-1/2 x 1	10	\$8.43
402-290	2-1/2 x 2-1/2 x 1-1/4	10	\$8.43
402-291	2-1/2 x 2-1/2 x 1-1/2	10	\$8.43
402-292	2-1/2 x 2-1/2 x 2	10	\$8.43
402-333	3 x 3 x 1/2	10	\$12.05
402-334	3 x 3 x 3/4	10	\$12.05
402-335	3 x 3 x 1	10	\$12.05
402-336	3 x 3 x 1-1/4	10	\$12.05
402-337	3 x 3 x 1-1/2	10	\$12.05
402-338	3 x 3 x 2	6	\$12.05
402-417	4 x 4 x 1	6	\$20.14
402-419	4 x 4 x 1-1/2	10	\$20.14
402-420	4 x 4 x 2	10	\$20.14
402-422	4 x 4 x 3	6	\$20.14
402-490	5 x 5 x 4	3	\$52.62
402-525	6 x 6 x 1	1	\$68.26
402-528	6 x 6 x 2	3	\$68.26
402-530	6 x 6 x 3	5	\$68.26
402-532	6 x 6 x 4	2	\$68.26
402-578	8 x 8 x 2	3	\$147.62
402-580	8 x 8 x 3	4	\$147.62
402-582	8 x 8 x 4	2	\$147.62
402-621F	10 x 2	1	\$807.80
402-622F	10 x 2-1/2	1	\$813.15
402-623F	10 x 3	1	\$864.51
402-624F	10 x 4	1	\$937.41
402-661F	12 x 2	1	\$1,037.12
402-663F	12 x 3	1	\$1,117.40
402-664F	12 x 4	1	\$1,209.72

SCHEDULE 40 PVC FITTINGS

THREADED TEE

(fipt x fipt x fipt)



Part No.	Size-In.	Box	Price
405-005	1/2	50	\$1.44
405-007	3/4	50	\$2.26
405-010	1	50	\$3.13
405-012	1-1/4	25	\$4.33
405-015	1-1/2	25	\$4.47
405-020	2	10	\$5.92
405-025	2-1/2"	5	\$21.09

STREET TEE

(spig x soc x soc)



Part No.	Size-In.	Box	Price
444-005	1/2	25	\$2.03
444-007	3/4	15	\$2.71
444-010	1	15	\$3.51
444-012	1-1/4	10	\$5.62
444-015	1-1/2	10	\$7.77
444-020	2	10	\$13.53

MANIFOLD TEE

(spig x soc x mipt)



Part No.	Size-In.	Box	Price
476-010	1	20	\$7.43

MANIFOLD TEE

(spig x soc x fipt)



Part No.	Size-In.	Box	Price
477-010	1	25	Call

90° ELBOW

(soc x soc)



Part No.	Size-In.	Box	Price
406-003	3/8	50	\$1.59
406-005	1/2	50	\$0.32
406-007	3/4	50	\$0.35
406-010	1	50	\$0.64
406-012	1-1/4	25	\$1.12
406-015	1-1/2	25	\$1.21
406-020	2	25	\$1.89
406-025	2-1/2	10	\$5.76
406-030	3	10	\$6.89
406-040	4	8	\$12.32
406-050	5	4	\$31.84
406-060	6	4	\$39.19
406-080	8	2	\$100.90
406-100	10	1	\$950.17
406-120	12	1	\$1,274.36

90° REDUCING ELBOW

(soc x soc)



Part No.	Size-In.	Box	Price
406-053	3/8 x 1/2	50	\$0.92
406-101	3/4 x 1/2	50	\$0.64
406-130	1 x 1/2	50	\$0.95
406-131	1 x 3/4	50	\$1.12
406-166	1-1/4 x 1/2	25	\$1.80
406-167	1-1/4 x 3/4	25	\$1.80
406-168	1-1/4 x 1	25	\$1.80
406-209	1-1/2 x 1/2	25	\$2.85
406-211	1-1/2 x 1	25	\$2.85
406-212	1-1/2 x 1-1/4	25	\$2.85
406-249	2 x 1	10	\$3.52
406-250	2 x 1-1/4	10	\$3.52
406-251	2 x 1-1/2	10	\$4.86
406-292N	2-1/2 x 2	10	\$5.69

90° SWEEP ELBOW

(soc x soc)



Part No.	Size-In.	Box	Price
406-005S	1/2	25	\$2.42
406-007S	3/4	25	\$2.77
406-010S	1	25	\$4.30
406-012S	1-1/4	25	\$5.97
406-015S	1-1/2	25	\$6.87
406-020S	2	25	\$7.78

90° LONG SWEEP ELBOW

(soc x soc)



Part No.	Size-In.	Box	Price
406-025LSF	2-1/2	1	Call
406-030LSF	3	1	\$103.65
406-040LSF	4	1	\$128.17
406-060LSF	6	1	\$202.62
406-080LSF	8	1	\$415.35

90° ELBOW

(soc x fipt)



Part No.	Size-In.	Box	Price
407-005	1/2	50	\$0.39
407-007	3/4	50	\$0.45
407-010	1	50	\$0.85
407-012	1-1/4	25	\$1.41
407-015	1-1/2	25	\$1.57
407-020	2	10	\$4.05
407-025	2-1/2	10	\$10.00
407-030	3	8	\$15.00
407-040	4	4	\$22.73

90° REDUCING ELBOW

(soc x fipt)



Part No.	Size-In.	Box	Price
407-053	3/8 x 1/2	50	\$1.08
407-074	1/2 x 3/4	50	\$0.85
407-101	3/4 x 1/2	50	\$0.47
407-130	1 x 1/2	50	\$1.30
407-131	1 x 3/4	50	\$1.89
407-168	1-1/4 x 1	25	\$1.89
407-211	1-1/2 x 1	25	\$3.14
407-212	1-1/2 x 1-1/4	20	\$3.27
407-250	2 x 1-1/4	10	\$5.43
407-251	2 x 1-1/2	10	\$5.43

90° THREADED ELBOW

(fipt x fipt)



Part No.	Size-In.	Box	Price
408-005	1/2	50	\$0.76
408-007	3/4	50	\$1.12
408-010	1	50	\$2.41
408-012	1-1/4	25	\$2.58
408-015	1-1/2	25	\$3.26
408-020	2	10	\$4.95

90° STREET ELBOW

(spig x soc)



Part No.	Size-In.	Box	Price
409-005	1/2	50	\$0.89
409-007	3/4	50	\$1.10
409-010	1	50	\$1.89
409-012	1-1/4	25	\$2.26
409-015	1-1/2	25	\$2.50
409-020	2	10	\$4.82
409-025	2-1/2	10	\$8.64
409-030	3	5	\$10.66
409-040	4	6	\$19.84
409-050	5	2	\$47.45
409-060	6	2	\$59.96
409-080	8	2	\$153.37
409-100	10	1	Call
409-120	12	1	Call

90° STREET ELBOW

(mipt x soc)



Part No.	Size-In.	Box	Price
410-005	1/2	50	\$0.69
410-007	3/4	50	\$0.81
410-010	1	50	\$1.36
410-012	1-1/4	25	\$1.89
410-015	1-1/2	25	\$1.98
410-020	2	10	\$4.87
410-101	3/4 x 1/2	50	\$0.99
410-102	3/4 x 1	50	\$1.68

90° STREET ELBOW

(mipt x fipt)



Part No.	Size-In.	Box	Price
412-005	1/2	50	\$0.92
412-007	3/4	50	\$1.12
412-010	1	50	\$1.94
412-012	1-1/4	25	\$2.41
412-015	1-1/2	25	\$2.62
412-020	2	10	\$4.98
412-030	3	8	\$17.82

90° HDPE STREET ELBOW

(mipt x fipt)



Part No.	Size-In.	Box	Price
M412-005	1/2	50	\$0.86
M412-007	3/4	50	\$1.04
M412-010	1	50	\$1.81
M412-012	1-1/4	25	\$2.39
M412-015	1-1/2	25	\$2.71

SCHEDULE 40 PVC FITTINGS

SIDE OUTLET ELBOW (soc x soc x soc)



Part No.	Size-In.	Box	Price
413-005	1/2	50	\$1.71
413-007	3/4	50	\$2.33
413-010	1	25	\$2.98
413-015	1-1/2	10	\$3.28
413-020	2	10	\$4.55

SIDE OUTLET ELBOW (soc x soc x fipt)



Part No.	Size-In.	Box	Price
414-005	1/2	50	\$1.67
414-007	3/4	50	\$2.56
414-101	3/4 x 3/4 x 1/2	50	\$2.16
414-130	1 x 1 x 1/2	50	\$2.83

60° ELBOW (soc x soc)



Part No.	Size-In.	Box	Price
424-005F	1/2	7	\$96.50
424-007F	3/4	6	\$107.29
424-010F	1	3	\$108.96
424-012F	1-1/4	16	\$116.19
424-015F	1-1/2	16	\$134.07
424-020F	2	1	\$176.16
424-025F	2-1/2	10	\$193.11
424-030F	3	8	\$220.17
424-040F	4	1	\$258.49
424-050F	5	1	\$297.66
424-060F	6	1	\$361.94
424-080F	8	1	\$481.30
424-100F	10	1	\$988.48
424-120F	12	1	\$1,258.30

45° ELBOW (soc x soc)



Part No.	Size-In.	Box	Price
417-005	1/2	50	\$0.52
417-007	3/4	50	\$0.81
417-010	1	50	\$0.97
417-012	1-1/4	25	\$1.36
417-015	1-1/2	25	\$1.70
417-020	2	25	\$2.22
417-025	2-1/2	10	\$5.77
417-030	3	10	\$8.95
417-040	4	5	\$16.05
417-050	5	5	\$31.84
417-060	6	8	\$39.66
417-080	8	3	\$95.38
417-100	10	1	\$620.75
417-120	12	1	\$919.86

45° STREET ELBOW (spig x soc)



Order No.	Size-In.	Box	Price
427-005	1/2	50	\$0.52
427-007	3/4	50	\$0.81
427-010	1	50	\$0.97
427-012	1-1/4	25	\$1.36
427-015	1-1/2	25	\$1.70
427-020	2	25	\$2.22
427-025	2-1/2	10	\$7.21
427-030	3	10	\$8.95
427-040	4	5	\$16.05
427-050	5	2	\$48.26
427-060	6	4	\$49.57
427-080	8	2	\$119.23
427-100	10	1	Call
427-120	12	1	Call

30° ELBOW (soc x soc)



Part No.	Size-In.	Box	Price
415-005F	1/2	25	\$29.84
415-007F	3/4	25	\$30.00
415-010F	1	25	\$32.85
415-012F	1-1/4	15	\$35.55
415-015F	1-1/2	5	\$36.06
415-020F	2	1	\$37.38
415-025F	2-1/2	25	\$44.10
415-030F	3	1	\$47.17
415-040F	4	1	\$56.80
415-050F	5	1	\$78.77
415-060F	6	1	\$91.26
415-080F	8	1	\$154.27
415-100F	10	1	\$232.80
415-120F	12	1	\$368.26

22-1/2° ELBOW (soc x soc)



Part No.	Size-In.	Box	Price
416-005	1/2	20	\$0.74
416-007	3/4	20	\$1.15
416-010	1	20	\$1.38
416-012	1-1/4	20	\$1.93
416-015	1-1/2	20	\$2.42
416-020	2	20	\$3.17
416-025F	2-1/2	25	\$44.10
416-030	3	5	\$12.78
416-040	4	4	\$22.94
416-050F	5	1	\$78.77
416-060	6	4	\$56.64
416-080	8	4	\$136.26

22-1/2° STREET ELBOW (spigot x soc)



Part No.	Size-In.	Box	Price
442-005	1/2	50	\$0.74
442-007	3/4	50	\$1.15
442-010	1	50	\$1.38
442-012	1-1/4	20	\$1.93
442-015	1-1/2	25	\$2.42
442-020	2	20	\$3.17
442-025F	2-1/2	1	\$50.45
442-030	3	1	\$18.50
442-040	4	1	\$28.56
442-060F	6	1	\$117.01
442-080F	8	1	\$176.24
442-100F	10	1	\$272.75
442-120F	12	1	\$409.41

15° ELBOW (soc x soc)



Part No.	Size-In.	Box	Price
418-005F	1/2	25	\$29.84
418-007F	3/4	23	\$30.00
418-010F	1	20	\$32.85
418-012F	1-1/4	15	\$35.55
418-015F	1-1/2	25	\$36.06
418-020F	2	25	\$37.38
418-025F	2-1/2	18	\$44.10
418-030F	3	1	\$47.17
418-040F	4	1	\$56.80
418-050F	5	1	\$78.77
418-060F	6	1	\$91.26
418-080F	8	1	\$154.27
418-100F	10	1	\$232.80
418-120F	12	1	\$368.26

11-1/4° ELBOW (soc x soc)



Part No.	Size-In.	Box	Price
411-005F	1/2	52	\$29.84
411-007F	3/4	52	\$30.00
411-010F	1	52	\$32.85
411-012F	1-1/4	26	\$35.55
411-015	1-1/2	25	\$2.73
411-020	2	10	\$3.17
411-025F	2-1/2	25	\$44.10
411-030	3	10	\$12.78
411-040	4	4	\$22.94
411-050F	5	1	\$78.77
411-060F	6	1	\$91.26
411-080F	8	1	\$154.27
411-100F	10	1	\$232.80
411-120F	12	1	\$368.26

CROSS (soc x soc x soc x soc)



Part No.	Size-In.	Box	Price
420-005	1/2	50	\$1.21
420-007	3/4	50	\$2.00
420-010	1	50	\$2.50
420-012	1-1/4	25	\$3.30
420-015	1-1/2	25	\$3.74
420-020	2	10	\$5.51
420-025	2-1/2	10	\$11.70
420-030	3	5	\$14.35
420-040	4	4	\$21.26
420-050F	5	1	\$853.98
420-060F	6	1	\$841.88
420-080F	8	1	\$1,084.42
420-100F	10	1	\$1,312.47
420-120F	12	1	\$1,849.60

CROSS (soc x mipt)



Part No.	Size-In.	Box	Price
421A-010	1	50	\$2.94

SCHEDULE 40 PVC FITTINGS

COUPLING

(soc x soc)



Part No.	Size-In.	Box	Price
429-003	3/8	50	\$0.57
429-005	1/2	50	\$0.20
429-007	3/4	50	\$0.28
429-010	1	50	\$0.50
429-012	1-1/4	25	\$0.69
429-015	1-1/2	25	\$0.74
429-020	2	25	\$1.12
429-025	2-1/2	12	\$2.50
429-030	3	10	\$3.91
429-040	4	6	\$5.66
429-050	5	5	\$10.35
429-060	6	5	\$17.88
429-080	8	8	\$33.39
429-100F	10	1	\$171.26
429-120F	12	1	\$182.31

DEEP SOCKET COUPLING

(soc x soc)



Part No.	Size-In.	Box	Price
479-005N	1/2	50	\$0.40
479-007	3/4	50	\$0.98
479-015	1-1/2	50	\$1.93
479-020	2	60	\$3.20
479-025	2-1/2	25	\$4.11
479-030	3	15	\$6.19
479-040	4	8	\$12.44
479-050F	5	1	\$118.17

REDUCER COUPLING

(soc x soc)



Part No.	Size-In.	Box	Price
429-101	3/4 x 1/2	50	\$0.52
429-130	1 x 1/2	25	\$1.24
429-131	1 x 3/4	50	\$0.89
429-166	1-1/4 x 1/2	25	\$2.34
429-167	1-1/4 x 3/4	8	\$2.34
429-168	1-1/4 x 1	25	\$1.50
429-209	1-1/2 x 1/2	8	\$1.95
429-210	1-1/2 x 3/4	25	\$1.58
429-211	1-1/2 x 1	25	\$2.45
429-212	1-1/2 x 1-1/4	25	\$1.58
429-247	2 x 1/2	10	\$3.45
429-248	2 x 3/4	10	\$3.45
429-249	2 x 1	25	\$3.63
429-250	2 x 1-1/4	10	\$3.45
429-251	2 x 1-1/2	10	\$2.52
429-291	2-1/2 x 1-1/2	10	\$6.74
429-292	2-1/2 x 2	10	\$5.20
429-335	3 x 1	10	\$15.28
429-337	3 x 1-1/2	8	\$15.28
429-338	3 x 2	8	\$13.56
429-339	3 x 2-1/2	8	\$11.51
429-416	4 x 3/4	10	\$17.74
429-417	4 x 1	8	\$28.18
429-420	4 x 2	4	\$16.42
429-421	4 x 2-1/2	6	\$20.70
429-422	4 x 3	4	\$16.95
429-532	6 x 4	4	\$22.37

THREADED COUPLING

(fipt x fipt)



Part No.	Size-In.	Box	Price
430-005	1/2	50	\$0.40
430-007	3/4	50	\$0.74
430-010	1	50	\$0.97
430-012	1-1/4	10	\$3.27
430-101	3/4 x 1/2	50	\$0.96

IPS TO PIP ADAPTER

(spig x soc)



Part No.	Size-In.	Box	Price
431-060	6	5	\$13.59
431-080	8	10	\$16.74
431-100F	10	1	\$64.33
431-120F	12	1	\$98.22

RISER EXTENSION

(fipt x mipt)



Part No.	Size-In.	Box	Price
434-005	1/2	50	\$0.58
434-007	3/4	50	\$0.97
434-010	1	50	\$1.21

IPT ADAPTER

(mipt x fipt)



Part No.	Size-In.	Box	Price
446-003	3/8	50	\$0.97
446-012	1-1/4	25	\$2.22
446-053	3/8 x 1/2	50	\$0.97
446-074	1/2 x 3/4	50	\$1.21

SPIGOT FEMALE ADAPTER

(spig x fipt)



Part No.	Size-In.	Box	Price
478-005	1/2	50	\$0.40
478-007	3/4	25	\$0.47
478-010	1	50	\$0.74
478-012	1-1/4	25	\$1.04
478-015	1-1/2	20	\$1.29
478-020	2	20	\$1.89
478-030	3	10	\$6.41
478-040	4	5	\$10.64

FEMALE ADAPTER

(soc x fipt)



Part No.	Size-In.	Box	Price
435-003	3/8	50	\$1.16
435-005	1/2	50	\$0.35
435-007	3/4	50	\$0.45
435-010	1	50	\$0.52
435-012	1-1/4	25	\$0.81
435-015	1-1/2	25	\$0.92
435-020	2	10	\$1.24
435-025	2-1/2	10	\$3.14
435-030	3	10	\$4.22
435-040	4	6	\$7.00
435-050	5	5	\$18.12
435-060	6	5	\$25.76
435-080	8	2	\$48.56

REDUCING FEMALE ADAPTER

(soc x fipt)



Part No.	Size-In.	Box	Price
435-072	1/2 x 1/4	50	\$0.64
435-073	1/2 x 3/8	50	\$0.64
435-074	1/2 x 3/4	50	\$0.64
435-101	3/4 x 1/2	50	\$0.64
435-102	3/4 x 1	50	\$0.85
435-130	1 x 1/2	50	\$0.85
435-131	1 x 3/4	50	\$0.85
435-133	1 x 1-1/2	25	\$1.70

MALE ADAPTER

(mipt x spig)



Part No.	Size-In.	Box	Price
461-005	1/2	50	\$0.50
461-007	3/4	50	\$0.57
461-010	1	50	\$0.98
461-012	1-1/4	25	\$1.21
461-015	1-1/2	25	\$1.62
461-020	2	25	\$2.00

MALE ADAPTER

(mipt x soc)



Part No.	Size-In.	Box	Price
436-003	3/8	50	\$1.08
436-005	1/2	50	\$0.28
436-007	3/4	50	\$0.32
436-010	1	50	\$0.57
436-012	1-1/4	25	\$0.69
436-015	1-1/2	25	\$0.92
436-020	2	25	\$1.21
436-025	2-1/2	10	\$3.58
436-030	3	10	\$5.24
436-040	4	5	\$6.68
436-050	5	5	\$11.01
436-060	6	7	\$17.43
436-080	8	3	\$79.20
436-100F	10	1	\$288.06
436-120F	12	1	\$428.09

REDUCING MALE ADAPTER

(mipt x soc)



Part No.	Size-In.	Box	Price
436-053	3/8 x 1/2	50	\$0.57
436-073	1/2 x 3/8	50	\$0.57
436-074	1/2 x 3/4	50	\$0.57
436-075	1/2 x 1	50	\$0.77
436-101	3/4 x 1/2	50	\$0.52
436-102	3/4 x 1	50	\$0.81
436-131	1 x 3/4	50	\$1.74
436-132	1 x 1-1/4	50	\$1.89
436-133	1 x 1-1/2	50	\$2.13
436-168	1-1/4 x 1	25	\$2.13
436-169	1-1/4 x 1-1/2	25	\$2.13
436-212	1-1/2 x 1-1/4	25	\$2.58
436-213	1-1/2 x 2	25	\$2.58
436-251	2 x 1-1/2	10	\$2.94
436-252	2 x 2-1/2	10	\$4.57
436-294	2-1/2 x 3	10	\$5.53
436-296	2-1/2 x 4	10	\$8.49
436-342	3 x 4	10	\$8.85
436-537F	6 x 10	1	\$352.94

SCHEDULE 40 PVC FITTINGS

REDUCER BUSHING (spig x soc)



Part No.	Size-In.	Box	Price
437-072	1/2 x 1/4	50	\$0.60
437-073	1/2 x 3/8	50	\$0.60
437-101	3/4 x 1/2	50	\$0.33
437-130	1 x 1/2	50	\$0.60
437-131	1 x 3/4	50	\$0.60
437-166	1-1/4 x 1/2	25	\$0.81
437-167	1-1/4 x 3/4	25	\$0.81
437-168	1-1/4 x 1	25	\$0.81
437-209	1-1/2 x 1/2	25	\$0.86
437-210	1-1/2 x 3/4	25	\$0.86
437-211	1-1/2 x 1	25	\$0.86
437-212	1-1/2 x 1-1/4	25	\$0.86
437-247	2 x 1/2	10	\$1.41
437-248	2 x 3/4	10	\$1.41
437-249	2 x 1	10	\$1.41
437-250	2 x 1-1/4	10	\$1.41
437-251	2 x 1-1/2	25	\$1.41
437-287	2-1/2 x 1/2	10	\$2.27
437-288	2-1/2 x 3/4	10	\$2.27
437-289	2-1/2 x 1	10	\$2.27
437-290	2-1/2 x 1-1/4	10	\$2.27
437-291	2-1/2 x 1-1/2	10	\$2.27
437-292	2-1/2 x 2	10	\$2.27
437-334	3 x 3/4	10	\$3.34
437-335	3 x 1	10	\$3.34
437-336	3 x 1-1/4	10	\$3.34
437-337	3 x 1-1/2	10	\$3.34
437-338	3 x 2	10	\$3.34
437-339	3 x 2-1/2	10	\$3.34
437-420	4 x 2	6	\$7.48
437-421	4 x 2-1/2	6	\$7.48
437-422	4 x 3	6	\$7.48
437-486	5 x 2	5	\$10.52
437-488	5 x 3	5	\$10.52
437-490	5 x 4	5	\$10.52
437-528	6 x 2	5	\$18.53
437-530	6 x 3	5	\$18.53
437-532	6 x 4	5	\$18.53
437-534	6 x 5	5	\$18.53
437-578	8 x 2	4	\$73.05
437-580	8 x 3	4	\$73.05
437-582	8 x 4	4	\$64.56
437-583	8 x 5	4	\$84.37
437-585	8 x 6	4	\$64.56
437-623	10 x 3	2	Call
437-624	10 x 4	2	Call
437-626	10 x 6	2	\$439.40
437-628	10 x 8	4	\$439.40
437-664	12 x 4	2	\$654.32
437-666	12 x 6	2	\$654.32
437-668	12 x 8	2	\$488.66
437-670	12 x 10	2	\$488.66

REDUCER BUSHING (spig x fipt)



Part No.	Size-In.	Box	Price
438-071	1/2 x 1/8	50	\$0.69
438-072	1/2 x 1/4	50	\$0.69
438-073	1/2 x 3/8	50	\$0.69
438-098	3/4 x 1/4	50	\$0.69
438-101	3/4 x 1/2	50	\$0.52
438-127	1 x 1/8	25	\$0.85
438-129	1 x 3/8	50	\$0.85
438-130	1 x 1/2	50	\$0.85
438-131	1 x 3/4	50	\$0.85

REDUCER BUSHING - Continued (spig x fipt)



Part No.	Size-In.	Box	Price
438-166	1-1/4 x 1/2	25	\$1.30
438-167	1-1/4 x 3/4	25	\$1.30
438-168	1 1/4 x 1	25	\$2.78
438-206	1-1/2 x 1/8	25	\$1.50
438-207	1-1/2 x 1/4	25	\$1.50
438-209	1-1/2 x 1/2	25	\$1.50
438-210	1-1/2 x 3/4	25	\$1.50
438-211	1-1/2 x 1	25	\$1.50
438-212	1-1/2 x 1-1/4	25	\$1.50
438-245	2 x 1/4	10	\$2.00
438-247	2 x 1/2	10	\$2.00
438-248	2 x 3/4	10	\$2.00
438-249	2 x 1	10	\$2.00
438-250	2 x 1-1/4	10	\$2.00
438-251	2 x 1-1/2	10	\$2.00
438-287	2-1/2 x 1/2	10	\$2.91
438-288	2-1/2 x 3/4	10	\$2.91
438-289	2-1/2 x 1	10	\$2.91
438-290	2-1/2 x 1-1/4	10	\$2.91
438-291	2-1/2 x 1-1/2	10	\$2.91
438-292	2-1/2 x 2	10	\$2.91
438-334	3 x 3/4	10	\$3.34
438-335	3 x 1	10	\$3.34
438-336	3 x 1-1/4	10	\$3.34
438-337	3 x 1-1/2	10	\$3.34
438-338	3 x 2	10	\$3.34
438-339	3 x 2-1/2	10	\$3.34
438-420	4 x 2	6	\$7.46
438-421	4 x 2-1/2	6	\$7.46
438-422	4 x 3	6	\$7.46
438-488	5 x 3	5	\$14.56
438-490	5 x 4	6	\$14.56
438-528	6 x 2	5	\$27.32
438-530	6 x 3	5	\$27.32
438-532	6 x 4	5	\$27.32
438-534	6 x 5	5	\$27.32

THREADED BUSHING (mipt x fipt)



Part No.	Size-In.	Box	Price
439-052	3/8 x 1/4	50	\$1.50
439-071	1/2 x 1/8	50	\$1.50
439-072	1/2 x 1/4	50	\$1.50
439-073	1/2 x 3/8	50	\$1.50
439-098	3/4 x 1/4	50	\$0.92
439-099	3/4 x 3/8	50	\$0.92
439-101	3/4 x 1/2	50	\$0.92
439-130	1 x 1/2	50	\$1.30
439-131	1 x 3/4	50	\$1.30
439-166	1-1/4 x 1/2	25	\$1.93
439-167	1-1/4 x 3/4	25	\$1.93
439-168	1-1/4 x 1	25	\$1.93
439-209	1-1/2 x 1/2	25	\$2.33
439-210	1-1/2 x 3/4	25	\$2.33
439-211	1-1/2 x 1	25	\$2.33
439-212	1-1/2 x 1-1/4	25	\$2.33
439-248	2 x 3/4	10	\$2.50
439-249	2 x 1	10	\$2.50
439-250	2 x 1-1/4	10	\$2.50
439-251	2 x 1-1/2	10	\$2.50
439-292	2-1/2 x 2	10	\$8.73
439-338	3 x 2	10	\$10.32
439-339	3 x 2-1/2	10	\$10.32

CAP (soc)



Part No.	Size-In.	Box	Price
447-003	3/8	50	\$0.81
447-005	1/2	50	\$0.28
447-007	3/4	50	\$0.33
447-010	1	50	\$0.52
447-012	1-1/4	25	\$0.74
447-015	1-1/2	25	\$0.81
447-020	2	10	\$0.97
447-025	2-1/2	10	\$3.10
447-030	3	10	\$3.38
447-040	4	6	\$7.69
447-050	5	5	\$12.93
447-060	6	4	\$18.45
447-080	8	3	\$46.35
447-100F	10	1	\$290.60
447-120F	12	1	\$422.18

THREADED CAP (fipt)



Part No.	Size-In.	Box	Price
448-003	3/8	50	\$1.09
448-005	1/2	50	\$0.60
448-007	3/4	50	\$0.69
448-010	1	50	\$1.04
448-012	1 1/4	25	\$1.24
448-015	1 1/2	25	\$1.30
448-020	2	10	\$2.30
448-025	2 1/2	10	\$3.38
448-030	3	10	\$4.42
448-040	4	6	\$7.76
448-050	5	5	\$15.04
448-060	6	8	\$18.35

PLUG (spig)



Part No.	Size-In.	Box	Price
449-003	3/8	50	\$0.86
449-005	1/2	50	\$0.69
449-007	3/4	50	\$0.81
449-010	1	50	\$0.97
449-012	1-1/4	25	\$1.30
449-015	1-1/2	25	\$1.66
449-020	2	10	\$2.04
449-025	2-1/2	10	\$3.51
449-030	3	10	\$4.62
449-040	4	6	\$10.46
449-060F	6	1	\$100.82
449-080F	8	1	\$155.24
449-100F	10	1	\$356.37
449-120F	12	1	\$582.68

THREADED PLUG (mipt)



Part No.	Size-In.	Box	Price
450-003	3/8	50	\$0.93
450-005	1/2	50	\$0.86
450-007	3/4	50	\$0.92
450-010	1	50	\$1.50
450-012	1-1/4	25	\$1.58
450-015	1-1/2	25	\$1.69
450-020	2	10	\$2.18
450-025	2-1/2	10	\$3.03
450-030	3	10	\$4.58
450-040	4	6	\$10.35
450-060	6	6	\$30.34
450-080F	8	1	\$226.20
450-100F	10	1	\$450.77
450-120F	12	1	\$629.31

SCHEDULE 40 PVC FITTINGS

UNION (soc x soc)



Part No.	Size-In.	Box	Price
457-005	1/2	10	\$3.10
457-007	3/4	10	\$3.52
457-010	1	10	\$3.63
457-012	1-1/4	5	\$11.69
457-015	1-1/2	5	\$12.17
457-020	2	5	\$16.42
457-025	2-1/2	5	\$22.99
457-030	3	5	\$36.72
457-040	4	4	\$50.85
457-060	6	1	\$112.98

SNAP ON SADDLE (IPS O.D. x soc)



Part No.	Size-In.	Box	Price
463-005	1/2	25	\$0.71
463-007	3/4	25	\$0.78
463-010	1	50	\$1.50
463-012	1-1/4	50	\$2.33
463-015	1-1/2	25	\$2.83
463-020	2	20	\$4.14
463-101	3/4 x 1/2	25	\$0.92
463-130	1 x 1/2	50	\$1.50

WYE (soc x soc x soc)



Part No.	Size-In.	Box	Price
475-005	1/2	25	\$1.36
475-007	3/4	20	\$2.13
475-010	1	20	\$2.98
475-012	1-1/4	20	\$4.58
475-015	1-1/2	20	\$5.87
475-020	2	10	\$17.61
475-025	2-1/2	4	\$40.25
475-030	3	5	\$29.66
475-040	4	4	\$55.94
475-050F	5	1	Call
475-060	6	3	\$118.37
475-080	8	1	\$190.38
475-100	10	1	Call
475-120	12	1	Call
1/2" - 2" 235 PSI Max. Rating @ 73°F			
2-1/2" - 6" 150 PSI Max. Rating @ 73°F			
8" - 12" 100 PSI Max. Rating @ 73°F			

THREADED UNION (fipt x fipt)



Part No.	Size-In.	Box	Price
458-005	1/2	10	\$3.46
458-007	3/4	10	\$5.79
458-010	1	10	\$7.92
458-012	1-1/4	5	\$13.59
458-015	1-1/2	5	\$13.89
458-020	2	5	\$17.05
458-025	2-1/2	5	\$24.28
458-030	3	5	\$38.98
458-040	4	4	\$51.73
458-060	6	1	\$114.96

SNAP ON SADDLE (IPS O.D. x fipt)



Part No.	Size-In.	Box	Price
464-005	1/2	25	\$0.92
464-007	3/4	25	\$1.44
464-010	1	50	\$2.64
464-101	3/4 x 1/2	25	\$1.21
464-130	1 x 1/2	50	\$2.18
464-131	1 x 3/4	50	\$2.18
464-210	1-1/2 x 3/4	25	\$5.50

DOUBLE WYE (soc x soc x soc x soc)

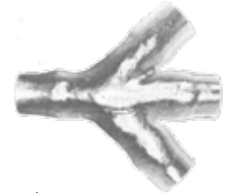

Part No.	Size-In.	Box	Price
476-020F	2	1	\$384.57
476-030F	3	1	\$633.42
476-040F	4	1	\$705.58
476-060F	6	1	\$803.53
476-080F	8	1	\$978.56
476-100F	10	1	\$1,794.41
476-120F	12	1	\$2,136.27
100 PSI Max. Rating @ 73°F			

INSERT ADAPTER (insert x spig)



Part No.	Size-In.	Box	Price
460-005	1/2	50	\$1.11
460-007	3/4	50	\$1.46
460-010	1	50	\$1.52
460-012	1-1/4	20	\$1.58
460-015	1-1/2	25	\$1.69
460-020	2	10	\$2.81
460-030	3	25	\$9.49
460-040	4	10	\$10.92
1432-060	6	8	\$63.39
1432-080	8	4	\$125.85

INSERT ADAPTER (insert x soc)



Part No.	Size-In.	Box	Price
474-005	1/2	50	\$1.01
474-007	3/4	50	\$1.21
474-010	1	50	\$1.29
474-012	1-1/4	25	\$2.04
474-015	1-1/2	25	\$2.26
474-020	2	25	\$4.19
474-030	3	15	\$12.50
474-040	4	15	\$14.29
474-060F	6	1	\$207.66
474-080F	8	1	\$329.90

EXPANSION COUPLING (spig x soc)



Part No.	Size-In.	Box	Price
S118-05	1/2	30	\$4.72
S118-07	3/4	24	\$5.41
S118-10	1	18	\$6.18
S118-12	1-1/4	12	\$11.74
S118-15	1-1/2	12	\$12.87
S118-20	2	8	\$19.89
S118-25	2-1/2	4	\$30.31
S118-30	3	3	\$37.88
S118-40	4	2	\$66.26

COMPRESSION COUPLING (c x c)



Part No.	Size-In.	Box	Price
S110-05	1/2	30	\$3.55
S110-07	3/4	24	\$4.47
S110-10	1	18	\$6.19
S110-12	1-1/4	12	\$9.15
S110-15	1-1/2	15	\$11.37
S110-20	2	12	\$10.09
S110-25	2-1/2	5	\$17.30
S110-30	3	4	\$28.67
S110-40	4	3	\$39.64
S110-60	6	1	\$111.67

SCHEDULE 80 PVC FITTINGS

TEE (soc x soc x soc)



Part No.	Size-In.	Box	Price
801-005	1/2	25	\$4.58
801-007	3/4	15	\$4.80
801-010	1	15	\$6.00
801-012	1-1/4	10	\$16.49
801-015	1-1/2	10	\$16.49
801-020	2	10	\$20.62
801-025	2-1/2	10	\$22.41
801-030	3	5	\$28.01
801-040	4	5	\$32.46
801-060	6	4	\$110.82
801-080	8	2	\$257.03
801-100	10	1	Call
801-120	12	1	\$2,998.13

REDUCING TEE (soc x soc x soc)



Part No.	Size-In.	Box	Price
801-101	3/4 x 3/4 x 1/2	15	\$3.51
801-130	1 x 1 x 1/2	15	\$5.07
801-131	1 x 1 x 3/4	15	\$5.07
801-157	1-1/4 x 1 x 3/4	15	\$8.37
801-158	1-1/4 x 1 x 1	15	\$8.37
801-159	1-1/4 x 1 x 1-1/4	15	\$8.37
801-166	1-1/4 x 1-1/4 x 1/2	10	\$13.99
801-167	1-1/4 x 1-1/4 x 3/4	10	\$11.01
801-168	1-1/4 x 1-1/4 x 1	15	\$11.01
801-202	1-1/2 x 1-1/4 x 1	10	\$11.01
801-209	1-1/2 x 1-1/2 x 1/2	10	\$11.01
801-210	1-1/2 x 1-1/2 x 3/4	15	\$11.01
801-211	1-1/2 x 1-1/2 x 1	10	\$11.01
801-212	1-1/2 x 1-1/2 x 1-1/4	10	\$11.01
801-247	2 x 2 x 1/2	10	\$13.94
801-248	2 x 2 x 3/4	10	\$13.94
801-249	2 x 2 x 1	10	\$13.94
801-250	2 x 2 x 1-1/4	10	\$21.26
801-251	2 x 2 x 1-1/2	10	\$13.94
801-287	2-1/2 x 2-1/2 x 1/2	10	\$21.31
801-288	2-1/2 x 2-1/2 x 3/4	10	\$21.31
801-289	2-1/2 x 2-1/2 x 1	10	\$18.19
801-290	2-1/2 x 2-1/2 x 1-1/4	10	\$18.19
801-291	2-1/2 x 2-1/2 x 1-1/2	10	\$18.19
801-292	2-1/2 x 2-1/2 x 2	10	\$18.19
801-333	3 x 3 x 1/2	5	\$25.56
801-334	3 x 3 x 3/4	5	\$28.85
801-335	3 x 3 x 1	5	\$25.56
801-336	3 x 3 x 1-1/4	5	\$25.56
801-337	3 x 3 x 1-1/2	5	\$25.56
801-338	3 x 3 x 2	5	\$25.56
801-339	3 x 3 x 2-1/2	5	\$25.56
801-416	4 x 4 x 3/4	5	\$50.56
801-417	4 x 4 x 1	5	\$50.56
801-418	4 x 4 x 1-1/4	5	\$50.56
801-419	4 x 4 x 1-1/2	5	\$41.31
801-420	4 x 4 x 2	5	\$41.31
801-421	4 x 4 x 2-1/2	5	\$74.36
801-422	4 x 4 x 3	5	\$41.31
801-426	4 x 4 x 6	4	\$202.44
801-525	6 x 6 x 1	4	\$82.54
801-526	6 x 6 x 1-1/4	4	\$107.43
801-527	6 x 6 x 1-1/2	4	\$107.43
801-528	6 x 6 x 2	4	\$82.54
801-529	6 x 6 x 2-1/2	4	\$107.34
801-530	6 x 6 x 3	4	\$82.54
801-532	6 x 6 x 4	5	\$110.82
801-578	8 x 8 x 2	2	\$300.07
801-579	8 x 8 x 2-1/2	2	\$330.16
801-580	8 x 8 x 3	2	\$300.07
801-582	8 x 8 x 4	2	\$300.07

REDUCING TEE - Continued (soc x soc x soc)



Part No.	Size-In.	Box	Price
801-585	8 x 8 x 6	2	\$257.03
801-623F	10 x 10 x 3	1	\$932.65
801-624F	10 x 10 x 4	1	\$966.21
801-626F	10 x 10 x 6	1	\$1,092.72
801-628F	10 x 10 x 8	1	\$1,225.86
801-664F	12 x 12 x 4	1	\$1,284.96
801-666F	12 x 12 x 6	1	\$1,418.86
801-668F	12 x 12 x 8	1	\$1,522.25
801-670F	12 x 12 x 10	1	\$1,691.54

STREET TEE (spig x soc x soc)



Part No.	Size-In.	Box	Price
844-005	1/2	25	\$5.72
844-007	3/4	15	\$6.00
844-010	1	15	\$7.50
844-012	1-1/4	10	\$20.62
844-015	1-1/2	10	\$20.62
844-020	2	10	\$25.76

TEE (soc x soc x fipt)



Part No.	Size-In.	Box	Price
802-005	1/2	20	\$7.24
802-007	3/4	15	\$9.36
802-010	1	15	\$10.96
802-012	1-1/4	15	\$11.71
802-015	1-1/2	10	\$13.96
802-020	2	10	\$16.98
802-030	3	5	\$36.23

REDUCING TEE (soc x soc x fipt)



Part No.	Size-In.	Box	Price
802-101	3/4 x 3/4 x 1/2	15	\$6.65
802-130	1 x 1 x 1/2	15	\$6.91
802-131	1 x 1 x 3/4	15	\$8.88
802-166	1-1/4 x 1-1/4 x 1/2	10	\$11.30
802-167	1-1/4 x 1-1/4 x 3/4	15	\$11.30
802-168	1-1/4 x 1-1/4 x 1	10	\$22.42
802-209	1-1/2 x 1-1/2 x 1/2	25	\$13.99
802-210	1-1/2 x 1-1/2 x 3/4	20	\$13.99
802-211	1-1/2 x 1-1/2 x 1	10	\$13.99
802-212	1-1/2 x 1-1/2 x 1-1/4	10	\$13.99
802-247	2 x 2 x 1/2	10	\$15.98
802-248	2 x 2 x 3/4	10	\$15.98
802-249	2 x 2 x 1	10	\$21.26
802-250	2 x 2 x 1-1/4	10	\$21.26
802-251	2 x 2 x 1-1/2	10	\$26.64
802-287	2-1/2 x 2-1/2 x 1/2	10	\$36.79
802-288	2-1/2 x 2-1/2 x 3/4	10	\$36.79
802-289	2-1/2 x 2-1/2 x 1	10	\$36.79
802-290	2-1/2 x 2-1/2 x 1-1/4	10	\$36.79
802-291	2-1/2 x 2-1/2 x 1-1/2	10	\$36.79
802-292	2-1/2 x 2-1/2 x 2	10	\$41.08
802-333	3 x 3 x 1/2	5	\$28.85
802-334	3 x 3 x 3/4	5	\$28.85
802-335	3 x 3 x 1	5	\$34.70
802-336	3 x 3 x 1-1/4	5	\$34.70
802-337	3 x 3 x 1-1/2	5	\$34.70
802-338	3 x 3 x 2	5	\$44.31
802-339	3 x 3 x 2-1/2	5	\$62.32
802-415	4 x 4 x 1/2	5	\$50.77
802-416	4 x 4 x 3/4	5	\$50.77
802-417	4 x 4 x 1	5	\$50.77

REDUCING TEE - Continued (soc x soc x fipt)



Part No.	Size-In.	Box	Price
802-418	4 x 4 x 1-1/4	1	\$50.77
802-419	4 x 4 x 1-1/2	5	\$50.77
802-420	4 x 4 x 2	5	\$75.88
802-421	4 x 4 x 2-1/2	5	\$75.88
802-422	4 x 4 x 3	5	\$84.95
802-525	6 x 6 x 1	4	\$118.13
802-526	6 x 6 x 1-1/4	4	\$118.13
802-527	6 x 6 x 1-1/2	4	\$118.13
802-528	6 x 6 x 2	4	\$118.13
802-529	6 x 6 x 2-1/2	4	\$118.13
802-530	6 x 6 x 3	4	\$164.91
802-532	6 x 6 x 4	2	\$172.78
802-578	8 x 8 x 2	2	\$321.97
802-580	8 x 8 x 3	1	\$321.97
802-582	8 x 8 x 4	2	\$321.97
802-621	10 x 10 x 2	1	Call
802-623	10 x 10 x 3	1	Call
802-624	10 x 10 x 4	1	Call
802-661	12 x 12 x 2	1	Call
802-663	12 x 12 x 3	1	Call
802-664	12 x 12 x 4	1	Call

THREADED TEE (fipt x fipt x fipt)



Part No.	Size-In.	Box	Price
805-005	1/2	20	\$5.29
805-007	3/4	15	\$5.89
805-010	1	15	\$13.00
805-012	1-1/4	10	\$13.78
805-015	1-1/2	10	\$16.70
805-020	2	10	\$17.96
805-025	2-1/2	5	\$65.39
805-030	3	5	\$68.29
805-040	4	5	\$110.98

90° ELBOW (soc x soc)



Part No.	Size-In.	Box	Price
806-005	1/2	20	\$1.62
806-007	3/4	20	\$2.07
806-010	1	10	\$3.34
806-012	1-1/4	10	\$4.47
806-015	1-1/2	10	\$4.79
806-020	2	25	\$5.79
806-025	2-1/2	5	\$13.55
806-030	3	5	\$15.23
806-040	4	5	\$23.16
806-050	5	4	\$59.38
806-060	6	4	\$65.90
806-080	8	2	\$181.64
806-100	10	1	Call
806-120	12	1	\$2,649.15

90° SWEEP ELBOW (soc x soc)



Part No.	Size-In.	Box	Price
806-005S	1/2	25	\$4.05
806-007S	3/4	25	\$5.24
806-010S	1	25	\$8.44
806-012S	1-1/4	25	\$11.17
806-015S	1-1/2	25	\$12.00
806-020S	2	25	\$14.54

SCHEDULE 80 PVC FITTINGS

90° LONG SWEEP ELBOW (soc x soc)



Part No.	Size-In.	Box	Price
806-005LSF	1/2	25	\$39.45
806-007LSF	3/4	25	\$44.29
806-010LSF	1	25	\$49.51
806-012LSF	1-1/4	25	\$83.73
806-015LSF	1-1/2	25	\$84.79
806-020LSF	2	10	\$91.67
806-025LSF	2-1/2	1	\$157.42
806-030LSF	3	5	\$171.73
806-040LSF	4	4	\$192.58
806-060LSF	6	1	\$294.95

90° STREET ELBOW (spig x soc)



Part No.	Size-In.	Box	Price
809-005	1/2	50	\$2.03
809-007	3/4	50	\$2.59
809-010	1	50	\$4.18
809-012	1-1/4	25	\$5.60
809-015	1-1/2	10	\$6.00
809-020	2	25	\$7.25
809-030	3	5	\$20.32
809-040	4	4	\$30.88
809-060	6	1	\$87.87
809-080	8	2	\$242.19
809-100	10	1	Call
809-120	12	1	Call

45° ELBOW (fipt x fipt)



Part No.	Size-In.	Box	Price
819-002	1/4	25	\$6.62
819-005	1/2	20	\$6.03
819-007	3/4	10	\$6.48
819-010	1	10	\$8.14
819-012	1-1/4	10	\$12.40
819-015	1-1/2	10	\$15.60
819-020	2	10	\$23.12
819-025	2-1/2	5	\$45.75
819-030	3	5	\$73.59
819-040	4	5	\$105.59

90° ELBOW (soc x fipt)



Part No.	Size-In.	Box	Price
807-002	1/4	25	\$6.38
807-005	1/2	20	\$6.38
807-007	3/4	20	\$7.51
807-010	1	20	\$8.12
807-012	1-1/4	10	\$9.36
807-015	1-1/2	10	\$11.18
807-020	2	10	\$14.47
807-030	3	5	\$34.56
807-040	4	5	\$65.19

60° ELBOW (soc x soc)



Part No.	Size-In.	Box	Price
824-005F	1/2	1	\$102.52
824-007F	3/4	1	\$121.05
824-010F	1	1	\$131.70
824-012F	1-1/4	1	\$134.29
824-015F	1-1/2	1	\$143.45
824-020F	2	1	\$181.97
824-025F	2-1/2	10	\$214.23
824-030F	3	1	\$214.63
824-040F	4	1	\$275.78
824-060F	6	1	\$492.54
824-080F	8	1	\$596.95
824-100F	10	1	\$1,019.94
824-120F	12	1	\$1,332.19

30° ELBOW (soc x soc)



Part No.	Size-In.	Box	Price
815-005F	1/2	1	\$36.95
815-007F	3/4	1	\$37.20
815-010F	1	1	\$40.70
815-012F	1-1/4	1	\$44.09
815-015F	1-1/2	25	\$44.70
815-020F	2	25	\$48.74
815-025F	2-1/2	18	\$54.00
815-030F	3	1	\$58.91
815-040F	4	1	\$77.24
815-060	6	5	Call
815-080F	8	1	\$236.40
815-100F	10	1	\$418.95
815-120F	12	1	\$612.32

90° REDUCING ELBOW (soc x fipt)



Part No.	Size-In.	Box	Price
807-101	3/4 x 1/2	10	\$3.87
807-130	1 x 1/2	10	\$6.18
807-131	1 x 3/4	10	\$6.18

45° ELBOW (soc x soc)



Part No.	Size-In.	Box	Price
817-005	1/2	20	\$3.05
817-007	3/4	20	\$4.67
817-010	1	15	\$7.00
817-012	1-1/4	10	\$8.92
817-015	1-1/2	10	\$10.54
817-020	2	10	\$13.66
817-025	2-1/2	5	\$28.69
817-030	3	5	\$34.92
817-040	4	5	\$62.88
817-060	6	4	\$79.19
817-080	8	2	\$171.70
817-100	10	1	Call
817-120	12	1	\$1,743.24

22-1/2° ELBOW (soc x soc)



Part No.	Size-In.	Box	Price
816-005	1/2	20	\$3.61
816-007	3/4	20	\$5.50
816-010	1	20	\$8.24
816-012	1-1/4	20	\$10.49
816-015	1-1/2	20	\$12.40
816-020	2	20	\$16.06
816-030	3	5	\$41.17
816-040	4	4	\$73.99
816-060	6	4	\$93.15
816-080	8	4	\$202.01
816-100F	10	1	\$418.95
816-120F	12	1	\$612.32

90° THREADED ELBOW (fipt x fipt)



Part No.	Size-In.	Box	Price
808-002	1/4	25	\$4.02
808-005	1/2	20	\$3.76
808-007	3/4	20	\$4.68
808-010	1	15	\$5.89
808-012	1-1/4	10	\$6.34
808-015	1-1/2	10	\$8.99
808-020	2	10	\$10.14
808-025	2-1/2	5	\$39.47
808-030	3	5	\$63.65
808-040	4	5	\$111.99

45° STREET ELBOW (spig x soc)



Order No.	Size-In.	Box	Price
827-005	1/2	50	\$3.05
827-007	3/4	50	\$4.67
827-010	1	50	\$7.00
827-012	1-1/4	25	\$8.92
827-015	1-1/2	25	\$10.54
827-020	2	10	\$13.66
827-025	2-1/2	12	\$18.02
827-030	3	10	\$34.92
827-040	4	5	\$62.88
827-060	6	4	\$93.15
827-080	8	2	\$202.01
827-100	10	1	Call
827-120	12	1	Call

22-1/2° STREET ELBOW (spig x soc)



Part No.	Size-In.	Box	Price
842-005	1/2	50	\$3.74
842-007	3/4	50	\$5.75
842-010	1	50	\$9.04
842-012	1-1/4	20	\$11.26
842-015	1-1/2	25	\$12.75
842-020	2	20	\$16.06
842-025	2-1/2	1	\$41.93
842-030	3	5	\$46.03
842-040	4	4	\$80.95
842-060	6	6	\$115.05
842-080	8	1	\$248.76
842-100F	10	1	\$490.82

90° STREET ELBOW (mipt x fipt)



Part No.	Size-In.	Box	Price
812-002	1/4	50	\$8.66

SCHEDULE 80 PVC FITTINGS

15° ELBOW (soc x soc)



Part No.	Size-In.	Box	Price
818-005F	1/2	1	\$36.95
818-007F	3/4	1	\$37.20
818-010F	1	1	\$40.70
818-012F	1-1/4	15	Call
818-015F	1-1/2	1	\$44.70
818-020F	2	25	\$48.74
818-025F	2-1/2	18	\$159.10
818-030F	3	1	\$58.91
818-040F	4	1	\$77.24
818-060F	6	1	\$144.42
818-080F	8	1	\$236.40
818-100F	10	1	\$418.95
818-120F	12	1	\$612.32

11-1/4° ELBOW (soc x soc)



Part No.	Size-In.	Box	Price
811-005F	1/2	1	\$36.95
811-007F	3/4	1	\$37.20
811-010F	1	50	\$40.70
811-012F	1-1/4	1	\$44.09
811-015	1-1/2	1	Call
811-020	2	10	Call
811-025F	2-1/2	25	\$54.00
811-030	3	10	Call
811-040	4	4	Call
811-060F	6	1	\$144.42
811-080F	8	1	\$236.40
811-100F	10	1	\$418.95
811-120F	12	1	\$612.32

WYE (soc x soc x soc)



Part No.	Size-In.	Box	Price
875-005	1/2	25	\$6.72
875-007	3/4	25	\$7.06
875-010	1	20	\$11.30
875-012	1-1/4	20	\$17.33
875-015	1-1/2	20	\$17.33
875-020	2	10	\$49.71
875-025	2-1/2	4	\$122.79
875-030	3	5	\$159.80
875-040	4	4	\$198.00
875-060	6	3	\$270.42
875-080	8	1	\$543.84
875-100F	10	1	\$1,849.42
875-120F	12	1	\$2,350.68
1/2" - 2" 235 PSI Max. Rating @ 73°F			
3" - 6" 150 PSI Max. Rating @ 73°F			
8" - 12" 100 PSI Max. Rating @ 73°F			

DOUBLE WYE (soc x soc x soc x soc)



Part No.	Size-In.	Box	Price
876-020F	2	1	\$462.24
876-030F	3	1	\$582.56
876-040F	4	1	\$1,057.91
876-060F	6	1	\$1,236.51
876-080F	8	1	\$1,473.21
876-100F	10	1	\$2,625.12
876-120F	12	1	\$3,696.77
100 PSI Max. rating @ 73°F			

CROSS (soc x soc x soc x soc)



Part No.	Size-In.	Box	Price
820-005	1/2	50	\$22.56
820-007	3/4	50	\$23.74
820-010	1	50	\$27.80
820-012	1-1/4	25	\$33.36
820-015	1-1/2	25	\$35.96
820-020	2	10	\$44.53
820-025	2-1/2	10	\$60.72
820-030	3	5	\$75.73
820-040	4	3	\$131.76
820-060F	6	1	\$890.48
820-080F	8	1	\$1,302.06
820-100F	10	1	\$2,100.11
820-120F	12	1	\$2,957.43

COUPLING (soc x soc)



Part No.	Size-In.	Box	Price
829-005	1/2	25	\$2.94
829-007	3/4	15	\$3.98
829-010	1	25	\$4.09
829-012	1-1/4	10	\$6.22
829-015	1-1/2	10	\$6.71
829-020	2	20	\$7.20
829-025	2-1/2	10	\$17.74
829-030	3	5	\$20.36
829-040	4	5	\$25.50
829-060	6	4	\$54.88
829-080	8	4	\$74.69
829-100	10	1	\$640.88
829-120	12	1	Call

REDUCER COUPLING (soc x soc)



Part No.	Size-In.	Box	Price
829-101	3/4 x 1/2	50	\$3.60
829-130	1 x 1/2	25	\$5.02
829-131	1 x 3/4	25	\$5.24
829-166	1-1/4 x 1/2	25	\$10.64
829-167	1-1/4 x 3/4	25	\$10.64
829-168	1-1/4 x 1	25	\$10.64
829-209	1-1/2 x 1/2	25	\$11.14
829-210	1-1/2 x 3/4	25	\$11.14
829-211	1-1/2 x 1	25	\$11.14
829-212	1-1/2 x 1-1/4	25	\$13.76
829-247	2 x 1/2	25	\$12.56
829-248	2 x 3/4	10	\$12.56
829-249	2 x 1	16	\$12.56

REDUCER COUPLING - Continued (soc x soc)



Part No.	Size-In.	Box	Price
829-250	2 x 1-1/4	10	\$12.56
829-251	2 x 1-1/2	10	\$12.56
829-291	2-1/2 x 1-1/2	10	\$16.76
829-292	2-1/2 x 2	10	\$16.76
829-335	3 x 1	8	\$38.32
829-336	3 x 1-1/4	6	\$38.32
829-337	3 x 1-1/2	8	\$38.32
829-338	3 x 2	8	\$30.86
829-339	3 x 2-1/2	5	\$44.00
829-416	4 x 3/4	4	\$63.72
829-417	4 x 1	4	\$63.72
829-419	4 x 1-1/2	4	\$63.72
829-420	4 x 2	4	\$58.82
829-421	4 x 2-1/2	4	\$58.82
829-422	4 x 3	4	\$58.13
829-528	6 x 2	6	\$145.55
829-529	6 x 2-1/2	4	\$174.54
829-530	6 x 3	12	\$147.04
829-532	6 x 4	4	\$118.57
829-579F	8 x 2-1/2	1	\$427.11
829-580F	8 x 3	1	\$391.40
829-582F	8 x 4	1	\$365.24
829-585	8 x 6	2	\$359.10
829-621F	10 x 2	1	\$630.01
829-623F	10 x 3	1	\$589.82
829-624F	10 x 4	1	\$556.66
829-626F	10 x 6	1	\$456.18
829-628	10 x 8	1	Call
829-663F	12 x 3	1	\$909.39
829-664F	12 x 4	1	\$776.85
829-666F	12 x 6	1	\$672.00
829-668F	12 x 8	1	\$520.32
829-670F	12 x 10	1	\$351.50

THREADED COUPLING (fipt x fipt)



Part No.	Size-In.	Box	Price
830-002	1/4"	25	\$3.52
830-005	1/2	25	\$3.28
830-007	3/4	25	\$4.69
830-010	1	15	\$5.03
830-012	1-1/4	10	\$6.22
830-015	1-1/2	10	\$13.84
830-020	2	10	\$14.54
830-025	2-1/2	5	\$34.70
830-030	3	5	\$40.69
830-040	4	5	\$70.46
830-060F	6	1	\$249.77
830-080F	8	1	\$367.29
830-100F	10	1	\$499.56
830-101	3/4 x 1/2	50	\$3.91

GROOVED COUPLING ADAPTER (groove x soc)



Part No.	Size-In.	Box	Price
833-012	1-1/4	10	\$8.18
833-015	1-1/2	10	\$9.11
833-020	2	5	\$10.60
833-025	2-1/2	5	\$22.88
833-030	3	5	\$27.28
833-040	4	5	\$30.96
833-060	6	5	\$66.85

SCHEDULE 80 PVC FITTINGS

FEMALE ADAPTER (soc x fipt)



Part No.	Size-In.	Box	Price
835-002	1/4	25	\$4.97
835-005	1/2	25	\$2.75
835-007	3/4	15	\$4.09
835-010	1	15	\$6.02
835-012	1-1/4	10	\$9.76
835-015	1-1/2	10	\$11.96
835-020	2	10	\$20.86
835-025	2-1/2	5	\$32.94
835-030	3	5	\$37.08
835-040	4	5	\$63.73
835-060	6	6	\$75.46
835-080	8	3	\$141.86
835-100F	10	1	\$361.11
835-120F	12	1	\$455.75

MALE ADAPTER (mipt x soc)



Part No.	Size-In.	Box	Price
836-005	1/2	25	\$3.44
836-007	3/4	25	\$3.79
836-010	1	10	\$6.55
836-012	1-1/4	10	\$7.66
836-015	1-1/2	10	\$11.01
836-020	2	10	\$15.92
836-025	2-1/2	5	\$18.09
836-030	3	5	\$20.08
836-040	4	5	\$35.73
836-060	6	5	\$79.37
836-080F	8	1	\$240.68
836-100F	10	1	\$288.06
836-120F	12	1	\$428.09

MALE ADAPTER (spig x mipt)



Part No.	Size-In.	Box	Price
861-005	1/2	50	\$3.45
861-007	3/4	25	\$5.09
861-010	1	50	\$7.52
861-012	1-1/4	25	\$8.15
861-015	1-1/2	25	\$9.11
861-020	2	25	\$10.60

REDUCER BUSHING (spig x soc)



Part No.	Size-In.	Box	Price
837-101	3/4 x 1/2	50	\$0.95
837-130	1 x 1/2	50	\$2.71
837-131	1 x 3/4	50	\$2.71
837-166	1-1/4 x 1/2	25	\$4.25
837-167	1-1/4 x 3/4	25	\$4.25
837-168	1-1/4 x 1	25	\$4.25
837-209	1-1/2 x 1/2	25	\$5.79
837-210	1-1/2 x 3/4	25	\$5.79
837-211	1-1/2 x 1	25	\$5.79
837-212	1-1/2 x 1-1/4	25	\$5.79
837-247	2 x 1/2	10	\$8.25
837-248	2 x 3/4	10	\$8.25
837-249	2 x 1	10	\$8.25
837-250	2 x 1-1/4	10	\$8.25
837-251	2 x 1-1/2	10	\$8.25
837-287	2-1/2 x 1/2	5	\$19.17
837-288	2-1/2 x 3/4	5	\$19.17
837-289	2-1/2 x 1	5	\$19.17

REDUCER BUSHING - Continued (spig x soc)



Part No.	Size-In.	Box	Price
837-290	2-1/2 x 1-1/4	10	\$14.34
837-291	2-1/2 x 1-1/2	10	\$14.34
837-292	2-1/2 x 2	15	\$14.34
837-335	3 x 1	10	\$22.74
837-336	3 x 1-1/4	10	\$22.74
837-337	3 x 1-1/2	10	\$22.74
837-338	3 x 2	10	\$22.74
837-339	3 x 2-1/2	15	\$22.74
837-417	4 x 1	6	\$40.42
837-418	4 x 1-1/4	6	\$40.42
837-419	4 x 1-1/2	6	\$40.42
837-420	4 x 2	6	\$31.49
837-421	4 x 2-1/2	6	\$31.49
837-422	4 x 3	6	\$31.49
837-524	6 x 3/4	5	\$52.56
837-525	6 x 1	5	\$49.93
837-526	6 x 1-1/4	5	\$52.56
837-527	6 x 1-1/2	5	\$52.56
837-528	6 x 2	5	\$43.78
837-529	6 x 2-1/2	5	\$67.89
837-530	6 x 3	5	\$43.78
837-532	6 x 4	5	\$43.78
837-577	8 x 1-1/2	4	\$161.99
837-578	8 x 2	4	\$153.36
837-580	8 x 3	6	\$153.36
837-582	8 x 4	6	\$106.52
837-585	8 x 6	4	\$106.52
837-621	10 x 2	2	Call
837-622	10 x 2-1/2	2	Call
837-623	10 x 3	2	Call
837-624	10 x 4	2	Call
837-626	10 x 6	4	Call
837-628	10 x 8	4	Call
837-663	12 x 3	2	Call
837-664	12 x 4	2	Call
837-666	12 x 6	2	Call
837-668	12 x 8	2	Call
837-670	12 x 10	2	Call

REDUCER BUSHING (spig x fipt)



Part No.	Size-In.	Box	Price
838-071	1/2 x 1/8	50	\$2.59
838-072	1/2 x 1/4	50	\$2.59
838-098	3/4 x 1/4	50	\$1.71
838-101	3/4 x 1/2	50	\$1.71
838-127	1 x 1/8	25	\$2.71
838-130	1 x 1/2	50	\$2.71
838-131	1 x 3/4	50	\$2.71
838-166	1-1/4 x 1/2	25	\$5.50
838-167	1-1/4 x 3/4	25	\$5.50
838-168	1-1/4 x 1	25	\$5.50
838-206	1-1/2 x 1/8	25	\$6.90
838-207	1-1/2 x 1/4	25	\$6.55
838-209	1-1/2 x 1/2	25	\$6.90
838-210	1-1/2 x 3/4	25	\$6.90
838-211	1-1/2 x 1	25	\$6.90
838-212	1-1/2 x 1-1/4	25	\$6.90
838-247	2 x 1/2	10	\$8.43
838-248	2 x 3/4	10	\$8.43
838-249	2 x 1	10	\$8.43
838-250	2 x 1-1/4	10	\$8.43
838-251	2 x 1-1/2	10	\$8.43
838-287	2-1/2 x 1/2	10	\$17.86
838-288	2-1/2 x 3/4	10	\$17.86
838-289	2-1/2 x 1	10	\$17.86

REDUCER BUSHING - Continued (spig x fipt)



Part No.	Size-In.	Box	Price
838-290	2-1/2 x 1-1/4	10	\$17.86
838-291	2-1/2 x 1-1/2	10	\$17.86
838-292	2-1/2 x 2	10	\$17.86
838-334	3 x 3/4	10	\$33.06
838-335	3 x 1	10	\$33.06
838-336	3 x 1-1/4	10	\$33.06
838-337	3 x 1-1/2	10	\$33.06
838-338	3 x 2	10	\$33.06
838-339	3 x 2-1/2	10	\$33.06
838-419	4 x 1-1/2	6	\$63.91
838-420	4 x 2	6	\$50.79
838-421	4 x 2-1/2	6	\$50.79
838-422	4 x 3	6	\$50.79
838-528	6 x 2	5	\$58.51
838-530	6 x 3	5	\$58.51
838-532	6 x 4	5	\$58.51

THREADED BUSHING (mipt x fipt)



Part No.	Size-In.	Box	Price
839-072	1/2 x 1/4	50	\$5.92
839-073	1/2 x 3/8	50	\$5.92
839-098	3/4 x 1/4	50	\$4.41
839-099	3/4 x 3/8	50	\$4.41
839-101	3/4 x 1/2	50	\$3.63
839-128	1 x 1/4	25	\$7.11
839-129	1 x 3/8	50	\$5.69
839-130	1 x 1/2	50	\$5.69
839-131	1 x 3/4	50	\$5.69
839-166	1-1/4 x 1/2	25	\$6.04
839-167	1-1/4 x 3/4	25	\$6.04
839-168	1-1/4 x 1	25	\$6.04
839-209	1-1/2 x 1/2	25	\$7.16
839-210	1-1/2 x 3/4	25	\$7.16
839-211	1-1/2 x 1	25	\$7.16
839-212	1-1/2 x 1-1/4	25	\$7.16
839-247	2 x 1/2	10	\$10.48
839-248	2 x 3/4	10	\$10.48
839-249	2 x 1	10	\$10.48
839-250	2 x 1-1/4	10	\$10.48
839-251	2 x 1-1/2	10	\$10.48
839-292	2-1/2 x 2	10	\$14.20
839-337	3 x 1-1/2	10	\$19.30
839-338	3 x 2	10	\$19.30
839-339	3 x 2-1/2	10	\$19.30
839-420	4 x 2	6	\$39.77
839-422	4 x 3	6	\$50.79

CAP (soc)



Part No.	Size-In.	Box	Price
847-005	1/2	25	\$2.87
847-007	3/4	25	\$3.03
847-010	1	15	\$5.38
847-012	1-1/4	10	\$6.49
847-015	1-1/2	10	\$6.49
847-020	2	10	\$12.82
847-025	2-1/2	5	\$26.18
847-030	3	5	\$30.64
847-040	4	5	\$51.66
847-060	6	4	\$128.51
847-080	8	3	\$164.99
847-100F	10	1	\$474.69
847-120F	12	1	\$712.42

SCHEDULE 80 PVC FITTINGS

THREADED CAP (fipt)



Part No.	Size-In.	Box	Price
848-002	1/4	25	\$3.60
848-005	1/2	25	\$3.60
848-007	3/4	25	\$4.02
848-010	1	15	\$5.07
848-012	1-1/4	10	\$6.04
848-015	1-1/2	10	\$6.90
848-020	2	10	\$13.55
848-025	2-1/2	5	\$27.10
848-030	3	5	\$31.91
848-040	4	5	\$56.18
848-060F	6	1	\$263.32
848-080F	8	1	\$343.08

PLUG (spig)



Part No.	Size-In.	Box	Price
849-005	1/2	50	\$2.69
849-007	3/4	50	\$2.99
849-010	1	50	\$3.37
849-012	1-1/4	25	\$4.31
849-015	1-1/2	10	\$4.72
849-020	2	10	\$6.25
849-025F	2-1/2	1	\$41.16
849-030F	3	1	\$49.65
849-040F	4	1	\$108.59
849-060F	6	1	\$301.91
849-080F	8	1	\$393.10
849-100F	10	1	\$639.21
849-120F	12	1	\$1,184.13

THREADED PLUG (mipt)



Part No.	Size-In.	Box	Price
850-002	1/4	50	\$3.10
850-005	1/2	25	\$2.77
850-007	3/4	25	\$2.87
850-010	1	15	\$3.52
850-012	1-1/4	10	\$5.20
850-015	1-1/2	10	\$6.31
850-020	2	10	\$6.48
850-025	2-1/2	5	\$18.09
850-030	3	5	\$21.11
850-040	4	5	\$41.10
850-060	6	6	\$48.86

FLANGE ONE PIECE (soc)



Part No.	Size-In.	Box	Price
851-005	1/2	25	\$8.89
851-007	3/4	25	\$9.50
851-010	1	15	\$10.58
851-012	1-1/4	15	\$10.90
851-015	1-1/2	20	\$11.14
851-020	2	10	\$14.82
851-025	2-1/2	10	\$22.88
851-030	3	10	\$25.27
851-040	4	5	\$32.00
851-060	6	5	\$50.31
851-080	8	2	\$90.03
851-100F	10	1	\$688.08
851-120F	12	1	\$835.58

VAN STONE FLANGE (soc)



Part No.	Size-In.	Box	Price
854-005	1/2	25	\$8.88
854-007	3/4	25	\$9.50
854-010	1	15	\$10.58
854-012	1-1/4	15	\$10.89
854-015	1-1/2	20	\$11.11
854-020	2	10	\$14.80
854-025	2-1/2	10	\$22.86
854-030	3	10	\$25.26
854-040	4	5	\$31.95
854-060	6	4	\$50.27
854-080	8	2	\$90.66
854-100	10	2	\$180.19
854-120	12	2	\$194.05

THREADED VAN STONE FLANGE (fipt)



Part No.	Size-In.	Box	Price
855-005	1/2	25	\$10.62
855-007	3/4	25	\$12.47
855-010	1	15	\$13.63
855-012	1-1/4	15	\$18.79
855-015	1-1/2	20	\$20.53
855-020	2	10	\$21.00
855-025	2-1/2	10	\$48.27
855-030	3	10	\$49.66
855-040	4	5	\$90.28
855-060	6	1	\$141.98
855-080	8	1	\$175.93
855-100F	10	1	\$496.11

BLIND FLANGE



Part No.	Size-In.	Box	Price
853-005	1/2	25	\$12.47
853-007	3/4	25	\$14.84
853-010	1	15	\$20.28
853-012	1-1/4	20	\$24.89
853-015	1-1/2	15	\$24.89
853-020	2	10	\$37.20
853-025	2-1/2	10	\$60.59
853-030	3	10	\$73.12
853-040	4	8	\$91.09
853-060	6	5	\$110.69
853-080	8	5	\$138.55
853-100	10	3	Call
853-120	12	2	Call

UNION (soc x soc)



Part No.	Size-In.	Box	Price
8057-005	1/2	20	\$6.02
8057-007	3/4	20	\$7.65
8057-010	1	15	\$8.73
8057-012	1-1/4	10	\$17.34
8057-015	1-1/2	10	\$19.64
8057-020	2	5	\$26.62
8057-025	2-1/2	5	\$42.46
8057-030	3	5	\$49.57
8057-040	4	4	\$69.04
8057-060	6	1	\$153.45

THREADED UNION (fipt x fipt)



Part No.	Size-In.	Box	Price
8058-005	1/2	20	\$6.98
8058-007	3/4	20	\$9.78
8058-010	1	15	\$13.00
8058-012	1-1/4	10	\$24.82
8058-015	1-1/2	10	\$30.73
8058-020	2	5	\$47.27
8058-025	2-1/2	5	\$79.96
8058-030	3	5	\$119.92
8058-040	4	4	\$140.94
8058-060	6	1	\$313.18

GROOVED COUPLING ADAPTER (groove x soc)



Part No.	Size-In.	Box	Price
833-012	1-1/4	10	\$8.15
833-015	1-1/2	10	\$9.11
833-020	2	5	\$10.60
833-025	2-1/2	5	\$22.88
833-030	3	5	\$27.28
833-040	4	5	\$30.96
833-060	6	5	\$66.85

STEEL GROOVED COUPLING



Part No.	Size-In.	Price
F087-90-08G	2	\$10.20
F087-90-10G	2.5	\$11.70
F087-90-12G	3	\$12.96
F087-90-16G	4	\$16.50
F087-90-24G	6	\$36.60
F087-90-32G	8	\$55.80
F087-90-40G	10	\$98.40
F087-90-48G	12	\$126.00

PVC SCHEDULE 80 NIPPLES

PVC Nipples furnished may be produced from extruded stock, or from molded grade PVC compounds. Both processes provide quality products meeting ASTM requirements. Half size nipples not shown are priced the same as the next full size. For example: 7-1/2" is priced the same as 8". Contact us for price & availability of sizes, lengths, and / or configurations not shown.



To order PVC Sch. 80 Threaded Nipples, list the Diameter Code followed by the Length Code. For Example, in ordering 2" x 6" Nipples, the order number will read 887-060

PVC SCHEDULE 80 NIPPLE

Diameter		1/8"	1/4"	3/8"	1/2"	3/4"	1"	1-1/4"	1-1/2"	2"	2-1/2"	3"	4"	6"	8"	10"	12"
Diameter Code		879	880	881	882	883	884	885	886	887	888	889	890	892	893	894	895
Length	Length Code	Price PC(6)	Price PC(6)	Price PC(6)	Price PC(6)	Price PC(6)	Price PC(6)	Price PC(6)	Price PC(6)	Price PC(6)	Price PC(6)	Price PC(6)	Price PC(6)	Price PC(6)	Price PC(6)	Price PC(6)	Price PC(6)
Close	005	\$1.24	\$1.29	\$1.74	\$1.16	\$1.24	\$1.64	\$2.38	\$2.59	\$3.41	\$11.71	\$13.98	\$22.84	\$25.05	\$45.04	\$49.70	\$58.73
1-1/2"	015	\$1.24	\$1.29	\$1.34	\$1.16	\$1.24	\$2.32	N/A	N/A	N/A	N/A	N/A	N/A	N/A	N/A	N/A	N/A
2"	020	\$1.40	\$1.58	\$1.72	\$1.24	\$1.24	\$1.83	\$2.45	\$2.87	\$3.41	N/A	N/A	N/A	N/A	N/A	\$49.70	N/A
2-1/2"	025	\$1.48	\$1.94	\$2.11	\$1.24	\$1.40	\$1.92	\$3.00	\$3.29	\$4.21	\$12.40	N/A	\$23.94	N/A	N/A	N/A	N/A
3"	030	\$1.77	\$2.11	\$1.72	\$1.40	\$1.40	\$2.07	\$2.77	\$3.27	\$4.09	\$13.34	\$15.25	\$23.94	N/A	N/A	N/A	N/A
3-1/2"	035	\$1.85	\$2.34	\$2.45	\$1.40	\$1.83	\$2.23	\$3.19	\$3.80	\$4.75	\$15.25	\$17.80	\$28.63	N/A	N/A	N/A	N/A
4"	040	\$1.97	\$2.45	\$2.06	\$1.64	\$1.91	\$2.38	\$3.19	\$4.36	\$5.64	\$17.25	\$20.36	\$31.69	\$32.03	N/A	N/A	N/A
4-1/2"	045	\$2.00	\$2.64	\$2.69	\$1.64	\$1.91	\$3.74	\$3.70	\$4.91	\$6.10	\$18.45	\$21.72	\$31.69	\$35.50	\$50.96	\$58.75	N/A
5"	050	\$2.19	\$2.66	\$2.94	\$1.83	\$2.28	\$2.87	\$3.87	\$5.09	\$6.54	\$19.43	\$22.84	\$31.69	\$38.96	\$56.00	\$64.66	\$82.78
5-1/2"	055	\$2.28	\$3.02	\$3.09	\$1.83	\$3.11	\$3.56	\$4.31	\$5.63	\$7.31	\$20.30	\$24.67	\$31.69	\$42.47	\$61.05	\$70.55	\$90.44
6"	060	\$2.34	\$3.05	\$3.18	\$1.91	\$2.38	\$3.24	\$4.08	\$5.25	\$7.50	\$21.28	\$28.53	\$33.95	\$46.34	\$65.99	\$81.02	\$98.10
7"	070	\$2.45	\$3.26	\$3.31	\$2.22	\$3.77	\$4.06	\$4.65	\$5.98	\$7.93	\$22.43	\$30.11	\$37.25	\$53.24	\$70.31	\$88.23	\$113.42
8"	080	\$2.77	\$3.45	\$3.55	\$2.38	\$2.77	\$3.83	\$4.90	\$6.46	\$8.29	\$23.51	\$31.00	\$39.40	\$60.30	\$76.77	\$97.44	\$128.73
9"	090	\$2.92	\$3.55	\$3.59	\$3.36	\$4.34	\$4.74	\$5.32	\$7.07	\$10.39	\$27.20	\$32.59	\$39.65	\$67.25	\$80.94	\$108.93	\$137.18
10"	100	\$3.36	\$3.61	\$3.72	\$2.59	\$3.19	\$4.54	\$5.71	\$7.21	\$11.27	\$28.82	\$35.47	\$42.14	\$74.66	\$85.81	\$119.19	\$152.78
11"	110	\$3.46	\$3.78	\$3.92	\$3.79	\$4.57	\$5.46	\$6.11	\$7.95	\$12.09	\$31.23	\$37.99	\$47.55	\$81.64	\$91.99	\$129.24	\$167.14
12"	120	\$3.65	\$3.95	\$4.12	\$2.87	\$3.60	\$5.25	\$6.46	\$8.72	\$12.92	\$31.45	\$38.63	\$54.89	\$88.61	\$107.14	\$135.01	\$177.01
13"	130	\$3.81	\$5.46	\$5.86	\$4.16	\$4.92	\$5.95	\$7.50	\$9.63	\$13.12	\$33.95	\$40.06	\$56.95	\$95.56	\$113.82	\$143.80	\$187.49
14"	140	\$4.23	\$5.51	\$6.08	\$4.30	\$5.09	\$6.37	\$7.76	\$10.55	\$13.35	\$35.33	\$43.45	\$58.35	\$102.54	\$119.34	\$154.47	\$201.46
15"	150	\$5.38	\$5.85	\$6.37	\$4.48	\$5.19	\$6.67	\$8.19	\$11.65	\$13.47	\$37.99	\$46.13	\$61.05	\$109.51	\$123.84	\$165.13	\$215.45
16"	160	\$5.95	\$6.22	\$6.54	\$4.66	\$5.41	\$6.99	\$8.54	\$12.24	\$13.86	\$40.66	\$48.82	\$63.79	\$116.47	\$134.48	\$175.80	\$233.71
17"	170	\$6.19	\$6.43	\$6.78	\$4.83	\$5.61	\$7.30	\$8.81	\$12.81	\$14.57	\$41.43	\$50.22	\$67.87	\$124.24	\$144.41	\$186.46	\$244.55
18"	180	\$6.36	\$6.64	\$7.01	\$5.05	\$5.86	\$7.60	\$9.18	\$13.39	\$14.92	\$42.14	\$52.88	\$76.53	\$130.38	\$152.37	\$198.54	\$258.43
19"	190	\$6.78	\$6.87	\$7.16	\$5.51	\$6.07	\$7.94	\$9.83	\$13.70	\$15.51	\$44.83	\$61.05	\$77.29	\$138.28	\$158.84	\$206.81	\$271.40
20"	200	\$7.21	\$7.38	\$7.36	\$5.38	\$6.28	\$8.25	\$10.21	\$13.94	\$16.34	\$46.65	\$64.42	\$82.76	\$144.32	\$166.60	\$210.43	\$298.27
22"	220	\$7.71	\$7.81	\$7.96	\$5.75	\$6.70	\$8.87	\$10.97	\$14.35	\$17.67	\$51.84	\$65.85	\$85.45	\$158.93	\$184.98	\$219.88	\$313.36
24"	240	\$7.79	\$8.12	\$8.15	\$6.14	\$7.17	\$9.48	\$11.73	\$14.74	\$19.01	\$52.88	\$72.57	\$91.10	\$172.84	\$183.85	\$231.50	\$341.33
30"	300	\$10.72	\$10.82	\$10.98	\$8.61	\$9.91	\$11.48	\$14.98	\$17.89	\$23.51	\$64.42	\$92.41	\$108.53	\$214.66	\$214.13	\$278.66	\$404.92
36"	360	\$12.61	\$13.29	\$14.52	\$9.69	\$11.71	\$13.41	\$17.08	\$20.27	\$31.23	\$78.71	\$95.58	\$128.91	\$257.52	\$255.39	\$333.49	\$484.83
42"	420	\$14.69	\$15.40	\$15.85	\$12.93	\$12.55	\$15.33	\$21.45	\$24.21	\$37.99	\$90.94	\$112.77	\$150.07	\$299.30	\$279.92	\$388.33	\$564.72
48"	480	\$16.79	\$17.38	\$17.95	\$13.60	\$14.52	\$17.25	\$22.57	\$26.17	\$42.50	\$98.34	\$124.82	\$193.16	\$341.28	\$333.93	\$443.18	\$644.63

1/8" Thru 2" diameter PVC Schedule 80 Nipples, up to 12" long, are packaged 25 per carton.

TBE: Use part number shown - TOE: Add a "1" in front of part Number, e.g. 1883-060 - Plain: Add a "P" at the end of part number, e.g. 883-060P

LENGTH OF CLOSE & SHORT NIPPLES

Size	1/8"	1/4"	3/8"	1/2"	3/4"	1"	1-1/4"	1-1/2"	2"	2-1/2"	3"	4"	6"	8"	10"	12"
Close	3/4"	7/8"	1"	1-1/8"	1-3/8"	1-1/2"	1-5/8"	1-3/4"	2"	2-1/2"	2-5/8"	2-7/8"	3-3/4"	3-5/8"	4"	4-3/8"
Short	1-1/2"	1-1/2"	1-1/2"	1-1/2"	1-1/2"	2"	2"	2"	2-1/2"	3"	3"	3-1/2"	4-1/2"	4-1/2"	4-1/2"	5"

PVC SCHEDULE 80 GROOVED NIPPLES

PVC Nipples furnished may be fabricated from extruded stock, or injection molded from PVC compounds. Both processes provide quality products meeting ASTM requirements.



GROOVE X PLAIN END

Part No.	Dia. x Length	Price
886-030PG	1-1/2" x 3"	\$3.44
887-030PG	2" x 3"	\$4.56
VG025PE	2-1/2" x 4"	\$7.68
889-040PG	3" x 4"	\$20.36
890-040PG	4" x 4"	\$31.69
VG06PE	6" x 6"	\$36.99
VG08PE	8" x 8"	\$65.62
VG10PE	10" x 12"	\$123.24



GROOVE X SOCKET

Part No.	Dia. x Length	Price
VG02SOC	2" x 5"	\$9.23
VG025SOC	2-1/2" x 5"	\$13.30
VG03SOC	3" x 6"	\$17.30
VG04SOC	4" x 6"	\$18.71
VG06SOC	6" x 9"	\$34.65
VG08SOC	8" x 10"	\$93.12
VG10SOC	10" x 12"	Call



GROOVE X MIPT

Part No.	Dia. x Length	Price
887-030TG	2" x 3"	\$4.56
VG025MPT	2-1/2" x 4"	\$12.25
889-040TG	3" x 4"	\$20.36
890-040TG	4" x 4"	\$31.69
VG06MPT	6" x 6"	\$52.93
VG08MPT	8" x 8"	\$88.83
VG10MPT	10" x 12"	Call



GROOVE X FIPT

Part No.	Dia. x Length	Price
VG02FPT	2" x 3"	\$10.20
VG025FPT	2-1/2" x 4"	\$15.60
VG03FPT	3" x 4"	\$18.48
VG04FPT	4" x 4"	\$28.99
VG06FPT	6" x 6"	\$119.96
VG08FPT	8" x 8"	\$190.55
VG10FPT	10" x 12"	Call



GROOVE X INSERT

Part No.	Dia. x Length	Price
VG02IN	2" x 5"	\$9.88
VG025IN	2-1/2" x 5"	\$13.72
VG03IN	3" x 6"	\$20.07
VG04IN	4" x 6"	\$23.83
VG06IN	6" x 8"	\$72.10
VG08IN	8" x 10"	\$147.48
VG10IN	10" x 12"	\$162.35



GROOVE X GROOVE

Part No.	Dia. x Length	Price
887-030GG	2" x 3"	\$4.56
VG025VG04	2-1/2" x 4"	\$8.70
889-040GG	3" x 4"	\$20.36
890-040GG	4" x 4"	\$31.69
VG06VG06	6" x 6"	\$44.28
VG08VG08	8" x 8"	\$69.31
VG10VG10	10" x 12"	\$125.30



PVC SOLVENT CEMENT

Part No.	Model No.	Size	Color	Use	Body	Setting	Price
15000	7115	1/4 Pint	Clear	Thru 4"	Regular	Fast	\$3.67
15001		1/2 Pint					\$6.03
15002		Pint					\$9.40
15003		Quart					\$11.60
15004	Gallon	\$41.28					
15010	7118	1/4 Pint	Gray	Thru 6"	Medium	Fast	\$3.73
15011		1/2 Pint					\$5.22
15012		Pint					\$7.88
15013		Quart					\$13.18
15014	Gallon	\$52.39					
15005	7116	1/4 Pint	Clear	Thru 6"	Medium	Fast	\$3.67
15006		1/2 Pint					\$5.25
15007		Pint					\$7.88
15008		Quart					\$13.23
15009	Gallon	\$52.32					
15015	7126	1/4 Pint	Clear	Thru 12"	Heavy	Medium	\$3.81
15016		1/2 Pint					\$5.26
15017		Pint					\$9.09
15018		Quart					\$15.09
15019	Gallon	\$53.18					
15020	7117	1/4 Pint	Gray	Thru 12"	Heavy	Medium	\$4.75
15021		1/2 Pint					\$5.26
15022		Pint					\$9.17
15023		Quart					\$15.01
15024	Gallon	\$53.08					
15025	7130	1/4 Pint	Blue	Thru 6"	Medium	Fast	\$4.10
15026		1/2 Pint					\$5.63
15027		Pint					\$8.12
15028		Quart					\$13.26
15029	Gallon	\$55.26					
10850	725™ WET'R Dry	1/4 Pint	Aqua Blue	Thru 6"	Medium	Extra Fast	\$7.08
10167		1/2 Pint					\$11.60
10166		Pint					\$19.64
10165		Quart					\$33.00
10164		Gallon					\$113.88

IPS® WELD-ON® SPECIAL PURPOSE ADHESIVE

Part No.	Model No.	Size	Color	Description	Price
10813	810™ (A&B) Kit	4 Oz.	White	Two-component, high strength, reactive adhesive for joining, fabricating & repairing PVC & CPVC pipe & fittings. Bonds PVC & CPVC to dissimilar materials, such as metal, concrete, clay & others.	Call
10812		Pint			Call
10811		Quart			Call
10810		Gallon			Call



IPS® WELD-ON® PRIMERS & CLEANERS

Part No.	Model No.	Size	Color	Type	Use	Price
15035	8155	1/4 Pint	Purple	Primer	All Sizes PVC & CPVC	\$4.22
15036		1/2 Pint				\$5.46
15037		Pint				\$8.06
15038		Quart				\$11.42
15039		Gallon				\$47.65
15040	8151	1/4 Pint	Clear	Primer	All Sizes PVC & CPVC	\$4.90
15041		1/2 Pint				\$6.34
15042		Pint				\$8.06
15043		Quart				\$12.65
15044	Gallon	\$49.95				
15030	7120	1/4 Pint	Clear	Cleaner	All Sizes PVC & CPVC ABS & Styrene	\$3.80
15031		1/2 Pint				\$4.79
15032		Pint				\$6.70
15033		Quart				\$9.28
15034		Gallon				\$39.33

IPS® WELD-ON® EMPTY METAL CANS

Part No.	Model No.	Can Size	Neck Size / Style	Applicator Options	Price
10015	MT-654	Pint	1-3/4"	DP-75, DP-150	Call
10014	MT-653	Quart	Triple Tight Paint Lid	3020	Call
10012	MT-651	Quart	1-3/4"	DQ-75, DQ-150	Call
10010	MT-648	Gallon	2-7/8"	4020,7020	Call



IPS® WELD-ON® APPLICATORS

Part No.	Model No.	Type	Size / Pipe Size	Can Options	Price
10004	DP-75	Dauber	3/4"/up to 1-1/2" Dia.	MT-654	Call
10003	DP-100	Dauber	1"/up to 1-1/2" Dia.	MT-654 Cleaners Only	Call
10005	DP-150	Dauber	1-1/2"/up to 3" Dia.	MT-654	Call
12429	DQ-75	Dauber	3/4"/up to 1-1/2" Dia.	MT-651	Call
10006	DQ-150	Dauber	1-1/2"/up to 3" Dia.	MT-651	Call
10832	CM-75	Dauber	3/4"/up to 1-1/2" Dia.	MT-654, MT-651	Call
10833	CM-150	Dauber	1-1/2"/up to 3" Dia.	MT-654, MT-651	Call
10007	3020	Roller	3" long / 3" - 6" Dia.	MT-653	Call
10008	7020	Roller	7" long / 6" Dia. & Up	MT-648	Call
10009	4020	Swab	4" long / 6" Dia. & Up	MT-648	Call



Intro 1 - Pvcot 2 - Valves 3 - Surface 4 - IPS Epoxy / Galv 5 - Suction Fittings 6 - PVC Fittings 7 - Sprinklers 8 - Malleable 9 - Hose 10 - Injectors / Filters 11 - Low Volume Formulas / TC

Sprinklers

Section 7

4	PRESSURE REGULATORS
5	NURSERY SPRINKLERS
6	NURSERY SPRINKLERS SENNINGER
7	NURSERY SPRINKLERS NELSON
8-11	AG SPRINKLERS NELSON
12	NELSON R33 ROTATOR
13	NELSON FEEDTUBE ASSEMBLIES
14	AG SPRINKLERS RAINBIRD
15-16	IMPACT SPRINKLERS
17	NOZZLES & ACCESSORIES
18	NOZZLES, RISERS & ACCESSORIES
19-20	SENNINGER PLASTIC IMPACT SPRINKLERS
21-23	BIG GUN
24	GUN ADAPTERS
25	GUN STANDS & CARTS



PRESSURE REGULATORS

NELSON MINI REGULATOR

For systems in which pressure ranges are excessive, the Nelson Mini Regulator provides uniform flow and distribution at each sprinkler. The acme thread outlet directly connects to the sprinkler body. Connection options include 1/2" FPT inlet x acme outlet or acme x acme. Pressure options include 20, 30, 35, 40, 45 and 50 PSI.

Part No.	Description	Price
10020-XXX	Mini Regulator 1/2" FIPT x Acme Thread	\$8.52
10099-XXX	Mini Regulator Acme x Acme	\$8.52

XXX = 020 (20 PSI), 030 (30 PSI), 035 (35 PSI),
040 (40 PSI), 045 (45 PSI), 050 (50 PSI)



NELSON PRESSURE REGULATORS

Part No.	Description	Flow Range (GPM)	Price
9491-XXX	Blue Top/Gray Lo-Flo 3/4" FIPT	.5 - 10	\$11.38
9610-XXX	Blue Top/Black Hi-Flo 3/4" FIPT	.5 - 10	\$12.69
9071-XXX	Blue Top/Black Hi-Flo 3/4" FIPT	2 - 16/20	\$17.74

XXX = 010 (10 PSI), 015 (15 PSI), 020 (20 PSI),
025 (25 PSI), 030 (30 PSI), 040 (40 PSI), 050 (50 PSI)



SENNINGER® PRESSURE REGULATORS

Part No.	Description	Flow Range (GPM)	Price
PRL-##LF	3/4" FIPT Low Flow	1/2 - 5 & 1/10 - 8	\$11.75
PMR-##MF	3/4" FIPT Medium Flow	4 - 16 & 2 - 20	\$17.00
PR-##HF	1-1/4" FIPT x 1" FIPT High Flow	10 - 32	\$34.00
PRXF-##	3" Socket x Socket	20 - 80/85/90/95/100	\$200.00

- 6, 10, 12, 15, 20, 25, 30, 35, 40, 50, 60 PSI



NETAFIM™ PRESSURE REGULATORS

Part No.	Description	Flow Range (GPM)	Price
32PRV.75-LF##V2	3/4" FIPT x 3/4" FIPT	0.25 - 4.4	\$12.34
32PRV.75-##V2K	3/4" FIPT x 3/4" MIPT	5.50 - 17.6	\$21.60
32PRV1.5-##V2K	1-1/2" MIPT x 1-1/2" MIPT	11.00 - 35.0	\$53.49
32PRV2-4##V2K	2" FIPT x 2" FIPT	22.00 - 70.0	\$205.71
32PRV2-6##V2K	2" FIPT x 2" FIPT	33.00 - 105.6	\$292.91
32PRV3-10##V2K	3" FIPT x 3" FIPT	55.00 - 175.0	\$529.71

- 9, 12, 15, 20, 25, 30, 35, 42, 43, 50, 57, 65 PSI

WHIZ HEAD®

Part No.	Description	Price
1973	1/2" FIPT Full Circle Rotary Sprinkler	\$10.50



SENNINGER® T-SPRAY™

Part No.	Description	Price
T-SPRAY SA	Standard Angle 1/2" MIPT Base, Nozzle Size #6 - 8	\$2.31
T-SPRAY HA	High Angle 1/2" MIPT Base, Nozzle Size #8	\$2.31



SENNINGER® SMOOTH DRIVE™

Part No.	Description	Price
SD2223M-2M	1/2" MIPT HA W/ NOZZLE	\$10.00
SD2223M-23S	1/2" X 3/4" SLIP HA W/NOZZLE	\$10.00
SD2223M-34S	3/4" X 1" SLIP HA W/NOZZLE	\$10.00



SENNINGER SUPER SPRAY®

Part No.	Description	Price
SUPERSPRAY	Complete Assembly with Nozzle & Plate	\$7.00



NURSERY SPRINKLERS

SENNINGER XCEL-WOBBLER® FOR UPRIGHT INSTALLATION

Part No.	Description	Price
XCEL HA-3/4" M	Xcel-Wobbler 3/4" MIPT, High Angle, Black Deflector	\$9.00
XCEL HA-1/2" M	Xcel-Wobbler 1/2" MIPT, High Angle, Black Deflector	\$9.00
XCEL MA-3/4" M	Xcel-Wobbler 3/4" MIPT, Mid-Angle, White Deflector	\$9.00
XCEL MA-1/2" M	Xcel-Wobbler 1/2" MIPT, Mid-Angle, White Deflector	\$9.00

• Mid Angle Apx 18° • High Angle Apx 24° • Nozzle Sizes Available # 6-14



SENNINGER WOBBLER® STANDARD ANGLE

Part No.	Description	Price
WOB-B06B2	Wobbler 1/2" MIPT #6 Nozzle Gold 3/32"	\$9.00
WOB-B07B2	Wobbler 1/2" MIPT #7 Nozzle Lime 7/64"	\$9.00
WOB-B08B2	Wobbler 1/2" MIPT #8 Nozzle Lavender 1/8"	\$9.00
WOB-B09B2	Wobbler 1/2" MIPT #9 Nozzle Gray 9/64"	\$9.00
WOB-B10B2	Wobbler 1/2" MIPT #10 Nozzle Turquoise 5/32"	\$9.00
WOB-B11B2	Wobbler 1/2" MIPT #11 Nozzle Yellow 11/64"	\$9.00
WOB-B12B2	Wobbler 1/2" MIPT #12 Nozzle Red 3/16"	\$9.00
WOB-B13B2	Wobbler 1/2" MIPT #13 Nozzle White 13/64"	\$9.00
WOB-B14B2	Wobbler 1/2" MIPT #14 Nozzle Blue 7/32"	\$9.00

Note: 3/4" Connection available upon request at same price as 1/2" models.



SENNINGER WOBBLER® LOW ANGLE

Part No.	Description	Price
WOB-B06B2LA	Wobbler 1/2" MIPT #6 Nozzle Gold 3/32"	\$9.00
WOB-B07B2LA	Wobbler 1/2" MIPT #7 Nozzle Lime 7/64"	\$9.00
WOB-B08B2LA	Wobbler 1/2" MIPT #8 Nozzle Lavender 1/8"	\$9.00
WOB-B09B2LA	Wobbler 1/2" MIPT #9 Nozzle Gray 9/64"	\$9.00
WOB-B10B2LA	Wobbler 1/2" MIPT #10 Nozzle Turquoise 5/32"	\$9.00
WOB-B11B2LA	Wobbler 1/2" MIPT #11 Nozzle Yellow 11/64"	\$9.00
WOB-B12B2LA	Wobbler 1/2" MIPT #12 Nozzle Red 3/16"	\$9.00
WOB-B13B2LA	Wobbler 1/2" MIPT #13 Nozzle White 13/64"	\$9.00
WOB-B14B2LA	Wobbler 1/2" MIPT #14 Nozzle Blue 7/32"	\$9.00

Note: 3/4" Connection available upon request at same price as 1/2" models.



SENNINGER I-MINI-WOBBLER® (BLUE DEFLECTOR) FOR INVERTED INSTALLATION

Part No.	Description	Price
WOB05M2-INV	1/2" MIPT, Inverted-Mini-Wobbler #5 Beige 5/64"	\$3.25
WOB06M2-INV	1/2" MIPT, Inverted-Mini-Wobbler #6 Gold 3/32"	\$3.25
WOB07M2-INV	1/2" MIPT, Inverted-Mini-Wobbler #7 Lime 7/64"	\$3.25
WOB08M2-INV	1/2" MIPT, Inverted-Mini-Wobbler #8 Lavender 1/8"	\$3.25



SENNINGER MINI-WOBBLER® (WHITE DEFLECTOR) FOR UPRIGHT INSTALLATION

Part No.	Description	Price
WOB04M2	1/2" MIPT, Mini-Wobbler #4 Light Blue 1/16"	\$3.25
WOB05M2	1/2" MIPT, Mini-Wobbler #5 Beige 5/64"	\$3.25
WOB06M2	1/2" MIPT, Mini-Wobbler #6 Gold 3/32"	\$3.25
WOB07M2	1/2" MIPT, Mini-Wobbler #7 Lime 7/64"	\$3.25
WOB08M2	1/2" MIPT, Mini-Wobbler #8 Lavender 1/8"	\$3.25
WOB09M2	1/2" MIPT, Mini-Wobbler #9 Gray 9/64"	\$3.25
WOB10M2	1/2" MIPT, Mini-Wobbler #10 Turquoise 5/32"	\$3.25



NELSON D10 SPRAY, S10 SPINNER & R10TG ROTATORS®

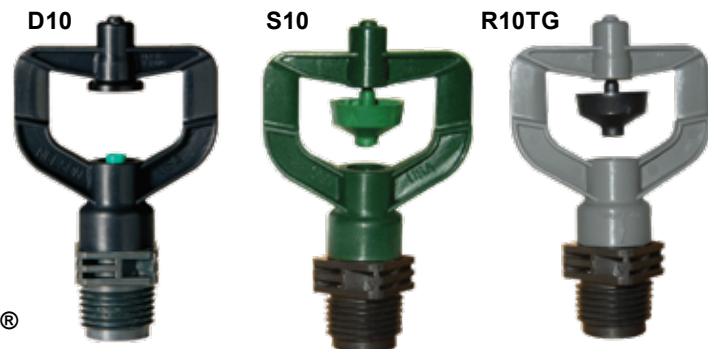

NELSON D10 SPRAYS, S10 SPINNERS & R10TG ROTATORS® (NOZZLES AND ADAPTER NOT INCLUDED)

Part No.	Description	Price
10135-001*	D10 complete acme body, plate, 2tn nozzle	\$4.01
10135-002	D10 complete 1/2" body, plate, 2tn nozzle	\$4.01
10078-1000*	S10 complete acme body, low angle green plate, 2tn nozzle	\$8.54
10078-1001	S10 complete 1/2" body, low angle green plate, 2tn nozzle	\$8.54
10078-2000*	S10 complete acme body, high angle black plate, 2tn nozzle	\$8.54
10078-2001	s10 complete 1/2" body, high angle black plate, 2tn nozzle	\$8.54
10078-3000*	s10 complete acme body, flat gray plate, 2tn nozzle	\$8.54
10078-3001	s10 complete 1/2" body, flat gray plate, 2tn nozzle	\$8.54
9914-8004*	R10TG complete acme body, low angle green plate, 2tn nozzle	\$6.34
9914-8001	R10TG complete 1/2" body, low angle green plate, 2tn nozzle	\$6.34
9914-8005*	R10TG complete acme body, high angle black plate, 2tn nozzle	\$6.34
9914-8002	R10TG complete 1/2" body, high angle black plate, 2tn nozzle	\$6.34
9914-8003*	R10TG complete acme body, flat gray plate, 2tn nozzle	\$6.34
9914-8000	R10TG complete 1/2" body, flat gray plate, 2tn nozzle	\$6.34

* Acme bases require adapter or feedtube assembly.

NELSON INLET ADAPTERS FOR ACME BODIED SPRINKLERS

Part No.	Size	Description	Price
9465	3/8"	Male Acme x 3/8" MIPT	\$1.30
9316	1/2"	Male Acme x 1/2" MIPT	\$1.30
9466	3/4"	Male Acme x 3/4" MIPT	\$1.34
10060-001	1/2"	Male Acme x PVC	\$1.10
10060-002	3/4"	Male Acme x PVC	\$1.10



NELSON 2TN NOZZLES FOR SPINNERS, ROTATORS® & SPRAYS

Part No.	Size	Description	Price
9306-078	5/64"	#10 Dark Blue	\$0.46
9306-086	11/128"	#11 Orange	\$0.46
9306-094	3/32"	#12 Purple	\$0.46
9306-102	13/128"	#13 Yellow	\$0.46
9306-109	7/64"	#14 Green	\$0.46
9306-117	15/128"	#15 Tan	\$0.46
9306-125	1/8"	#16 Dark Red	\$0.46
9306-133	17/128"	#17 Turquoise	\$0.46
9306-141	9/64"	#18 Gold	\$0.46
9306-156	5/32"	#20 Brown	\$0.46



NELSON SPRINKLER ASSEMBLY

Part No.	Description	Price
ASSY	Complete Sprinkler Assembly - D10, S10, R10TG	\$0.50

Note: Sprinkler is supplied unassembled unless assembly is ordered.

NELSON R10 & R10T ROTATORS®

9913-XXXX

	Thread	Plate	Nozzle
9913-	X	X	XX
	3/8" = 0	Red = 1	\$5.96
	1/2" = 1	White = 2	\$5.96
	Acme = 2	Blue = 3	\$5.96

R10



R10T

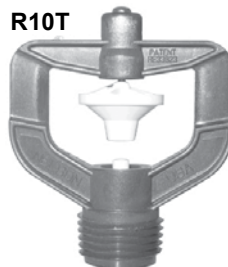

9914-XXXX

	Thread	Plate	Nozzle
9914-	X	X	XX
	3/8" = 0	Blue = 3	\$5.96
	1/2" = 1	Purple = 4	\$5.96
	Acme = 2	Brown = 5	\$6.92
		Gold = 6	\$6.92

R10 BODY, PLATE & NOZZLE - COMPLETE

Plate Option	2TN Nozzle Option	Noz. Size	Price
P2 9° Red	9306-040 - #5.1 Lt. Blue	.040"	\$5.96
	9306-045 - #5.8 Lt. Purple	.045"	
	9306-050 - #6.4 Dk. Green	.050"	
P4 9° White	9306-050 - #6.4 Dk. Green	.050"	\$5.96
	9306-055 - #7 Lt. Yellow	7/128"	
	9306-060 - #7.7 Lt. Red	.060"	
P6 9° Blue	9306-065 - #8.3 Gray	.065"	\$5.96
	9306-070 - #9 White	9/128"	
	9306-078 - #10 Dk. Blue	5/64"	

R10T BODY, PLATE & NOZZLE - COMPLETE

Plate Option	2TN Nozzle Option	Noz. Size	Price
P6 9° Blue P6 15° Purple	9306-065 - #8.3 Gray	.065"	\$5.96
	9306-070 - #9 White	9/128"	
	9306-078 - #10 Dk. Blue	5/64"	
P8 15° Gold P8 24° Brown	9306-086 - #11 Orange	11/128"	\$6.92
	9306-094 - #12 Purple	3/32"	
	9306-102 - #13 Yellow	13/128"	

R10 & R10T BODY

Part No.	Size	Description	Price
9205-000	3/8"	R10 Body Less Noz. & Plate	\$4.42
9722-000	3/8"	R10T Body Less Noz. & Plate	\$4.42
9205-001	1/2"	R10 Body Less Noz. & Plate	\$4.42
9722-001	1/2"	R10T Body Less Noz. & Plate	\$4.42
9205-002	Acme	R10 Body Less Noz. & Plate	\$4.42
9722-002	Acme	R10T Body Less Noz. & Plate	\$4.42

ROTOR PLATES

Part No.	Description	Price
9460	P2 9° Red (R10)	\$1.10
9208	P4 9° White (R10)	\$1.10
9350	P6 9° Blue (R10, R10T)	\$1.10
9723	P6 15° Purple (R10T)	\$1.10
10601	P8 24° Brown (R10T)	\$2.06
10684	P8 15° Gold (R10T)	\$2.06

2TN NOZZLES FOR R10 & R10T

Part No.	Noz. Size	Color	Price
9306-040	.040"	#5.1 Light Blue	\$0.46
9306-045	.045"	#5.8 Light Purple	\$0.46
9306-050	.050"	#6.4 Dark Green	\$0.46
9306-055	7/128"	#7 Light Yellow	\$0.46
9306-060	.060"	#7.7 Light Red	\$0.46
9306-065	.065"	#8.3 Gray	\$0.46
9306-070	9/128"	#9 White	\$0.46
9306-078	5/64"	#10 Dark Blue	\$0.46

R10 & R10T INLET ADAPTERS

Part No.	Size	Description	Price
9465	3/8"	Male Acme x 3/8" MNPT	\$1.30
9316	1/2"	Male Acme x 1/2" MNPT	\$1.30
9466	3/4"	Male Acme x 3/4" MNPT	\$1.34
10060-001	1/2"	Male Acme x 1/2" PVC Slip	\$1.10
10060-002	3/4"	Male Acme x 3/4" PVC Slip	\$1.10

Note: Add Inlet Adapters to Body, Nozzle & Plate for Total Unit List Price

FEED TUBE ACCESSORIES

Part No.	Description	Price
9195	Connector (CPSB)	\$0.97
9284	*5mm Feedtube 1,000' (305 M) Coil	\$162.00
9099	*10mm Feedtube 500' (152.4 M) Coil	\$192.00
9813	Coupler 10MM	\$1.40
9349	Punch Tool, 5mm Red (FT1 & FT2)	\$11.32
9810	Punch Tool, 7mm Blue (FT4)	\$14.14
9776	Punch Tool, 10mm White (FT5)	\$15.93
9835-003	Drill Punch Tool, 5mm (FT1 & FT2)	\$29.62
9835-002	Drill Punch Tool, 7mm (FT4)	\$26.04
9835-001	Drill Punch Tool, 10mm (FT5)	\$26.04
9845	Drill Installation Tool, (Installs #9739 Of FT5)	\$27.43
9986	Dual Goof Plug for FT1 & FT2 (Must Order in 20's)	\$0.13
9826	Plug, Rubber (Fits Inside of #9739 QC Barb)	\$0.91
9831	Plug, Goof (Fits in Place of #9739 QC Barb)	\$0.62
10287	Stake Installation Tool for the 6.3mm Stake	\$10.28
10288	Stake Installation Tool for the 8mm Stake	\$12.10
10301	Goof Plug for FT4	\$0.94

*NOTE: Tube Assembly Lengths Other Than 30" (for FT1, FT2), 36" (for FT4) & 48" (for FT5) are Available for Orders Totaling 50,000 Feet or More



NELSON R2000 ROTATOR®

COMPLETE R2000 ASSEMBLY SPECIFY PLATE, NOZZLE & ADAPTER SIZE

Part No.	Description	Price
R2000-2TN-TA	Complete R2000 w/ 2TN Nozzle & Threaded Adapter	\$15.56
R2000-2TN-PA	Complete R2000 w/ 2TN Nozzle & PVC Adapter	\$15.37
R2000-2FCN-TA	Complete R2000 w/ 2000FC Nozzle & Threaded Adapter	\$17.50
R2000-2FCN-PA	Complete R2000 w/ 2000FC Nozzle & PVC Adapter	\$17.31

Note: Sprinkler is supplied unassembled unless assembly is ordered.



R2000

R2000 CAP ASSEMBLY & ROTOR PLATE ONLY

Part No.	Description	Price
10519-1209	Cap Assembly w/ K2 9° Green Plate	\$14.64
10519-1215	Cap Assembly w/ K2 15° Yellow Plate	\$14.64
10519-1309	Cap Assembly w/ K3 9° Brown Plate	\$14.64
10519-1315	Cap Assembly w/ K3 15° Red Plate	\$14.64
10519-1324	Cap Assembly w/ K3 24° Gray Plate	\$14.64
10519-1406	Cap Assembly w/ K4 6° Turquoise Plate	\$14.64
10519-1409	Cap Assembly w/ K4 9° Purple Plate	\$14.64
10519-1412	Cap Assembly w/ K4 12° Wine Plate	\$14.64
10519-1415	Cap Assembly w/ K4 15° Gold Plate	\$14.64
10519-1424	Cap Assembly w/ K4 24° Black Plate	\$14.64
10519-1509	Cap Assembly w/ K5 9° Orange Plate	\$14.64
10519-1515	Cap Assembly w/ K5 15° Tan Plate	\$14.64
10519-1524	Cap Assembly w/ K5 24° Blue Plate	\$14.64



R2000 CAP ASSEMBLY ONLY (LESS PLATE)

Part No.	Description	Price
9422	Cap Assembly w/ Black Diffuser (for K3 & K4)	\$10.19
9422-002	Cap Assembly w/ White Diffuser (for K2)	\$10.19
9422-006	Cap Assembly w/ Diffuser (for K5)	\$10.19



R2000 2T BODY OR 2000FC NOZZLE BODY

Part No.	FCN Flow	Description	Price
9155		2T Body Only	\$1.58
9223-085	0.85 GPM	R2000 FCN Body (for K2 Plate)	\$3.98
9223-100	1.00 GPM	R2000 FCN Body (for K2 Plate)	\$3.98
9223-125	1.25 GPM	R2000 FCN Body (for K3 Plate)	\$3.98
9223-150	1.50 GPM	R2000 FCN Body (for K3 & K4 Plate)	\$3.98
9223-200	2.00 GPM	R2000 FCN Body (for K4 Plate)	\$3.98
9223-250	2.50 GPM	R2000 FCN Body (for K5 Plate)	\$3.98



R2000 2TN NOZZLES ONLY

Part No.	Size	Description	Price
9306-065	1/16"	#8.3 Gray Noz. (for K2 Plate)	\$0.46
9306-070	9/128"	#9 White Noz. (for K2 Plate)	\$0.46
9306-078	5/64"	#10 Dark Blue Noz. (for K2 Plate)	\$0.46
9306-086	11/128"	#11 Orange Noz. (for K3 Plate)	\$0.46
9306-094	3/32"	#12 Purple Noz. (for K3 Plate)	\$0.46
9306-102	13/128"	#13 Yellow Noz. (for K4 Plate)	\$0.46
9306-109	7/64"	#14 Green Noz. (for K4 Plate)	\$0.46
9306-117	15/128"	#15 Tan Noz. (for K5 Plate)	\$0.46
9306-125	1/8"	#16 Dark Red Noz. (for K5 Plate)	\$0.46



R2000 INLET ADAPTERS ONLY

Part No.	Size	Description	Price
9465	3/8"	Male Acme x 3/8" MNPT	\$1.30
9316	1/2"	Male Acme x 1/2" MNPT	\$1.30
9466	3/4"	Male Acme x 3/4" MNPT	\$1.30
10060-001	1/2"	Male Acme x 1/2" PVC Slip	\$1.11
10060-002	3/4"	Male Acme x 3/4" PVC Slip	\$1.11



NELSON R2000WF WINDFIGHTER ROTATOR®

COMPLETE R2000WF ASSEMBLY SPECIFY PLATE, NOZZLE & ADAPTER SIZE

Part No.	Description	Price
R2000WF-TA	Complete with Cap, Plate, Body, Nozzle & Threaded Adapter	\$15.56
R2000WF-PA	Complete with Cap, Plate, Body, Nozzle & PVC Adapter	\$15.37

Note: Sprinkler is supplied unassembled unless assembly is ordered.



R2000WF

R2000WF CAP ASSEMBLY ROTOR PLATE, BODY & NOZZLE ASSEMBLED - NO ADAPTER

Part No.	Description	Price
9928-1210	R2000WF with Purple Plate & #10 Nozzle	\$14.22
9928-1211	R2000WF with Purple Plate & #11 Nozzle	\$14.22
9928-1212	R2000WF with Purple Plate & #12 Nozzle	\$14.22
9928-1413	R2000WF with Green Plate & #13 Nozzle	\$14.22
9928-1414	R2000WF with Green Plate & #14 Nozzle	\$14.22
9928-1615	R2000WF with Red Plate & #15 Nozzle	\$14.22
9928-1616	R2000WF with Red Plate & #16 Nozzle	\$14.22
9928-1818	R2000WF with Gold Plate & #18 Nozzle	\$14.22
9928-2020	R2000WF with Brown Plate & #20 Nozzle	\$14.22



R2000WF CAP ASSEMBLY WITH PLATE ONLY

Part No.	Description	Price
10299-110	R2000WF Cap Assembly with WF-10 Purple Plate	\$12.22
10299-112	R2000WF Cap Assembly with WF-12 Purple Plate	\$12.22
10299-114	R2000WF Cap Assembly with WF-14 Green Plate	\$12.22
10299-116	R2000WF Cap Assembly with WF-16 Red Plate	\$12.22
10299-118	R2000WF Cap Assembly with WF-18 Gold Plate	\$12.22
10299-120	R2000WF Cap Assembly with WF-20 Brown Plate	\$12.22

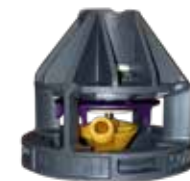

R2000WF BODY ONLY

Part No.	Description	Price
9920	WF Body (Female Acme Thread)	\$1.58



R2000WF NOZZLES ONLY

Part No.	Size	Description	Price
9306-078	5/64"	#10 Dark Blue (use with Purple Plate)	\$0.46
9306-086	11/128"	#11 Orange (use with Purple Plate)	\$0.46
9306-094	3/32"	#12 Purple (use with Purple Plate)	\$0.46
9306-102	13/128"	#13 Yellow (use with Green Plate)	\$0.46
9306-109	7/64"	#14 Green (use with Green Plate)	\$0.46
9306-117	15/128"	#15 Tan (use with Red Plate)	\$0.46
9306-125	1/8"	#16 Red (use with Red Plate)	\$0.46
9306-141	9/64"	#18 Gold (use with Gold Plate)	\$0.46
9306-156	5/32"	#20 Brown (use with Brown Plate)	\$0.46



R2000WF INLET ADAPTERS ONLY

Part No.	Size	Description	Price
9465	3/8"	Male Acme x 3/8" MNPT	\$1.30
9316	1/2"	Male Acme x 1/2" MNPT	\$1.30
9466	3/4"	Male Acme x 3/4" MNPT	\$1.34
10060-001	1/2"	Male Acme x 1/2" PVC Slip	\$1.11
10060-002	3/4"	Male Acme x 3/4" PVC Slip	\$1.11



NELSON R2000CW COW WASH ROTATOR®

COMPLETE R2000CW ASSEMBLY

Part No.	Description	Price
R2000CW-TA	Complete with Cap, Plate, Body, Nozzle & 1/2" MIPT Adapter	\$16.65

Note: Sprinkler is supplied unassembled unless assembly is ordered.

R2000CW COW WASH COMPONENTS

Part No.	Description	Price
9422-005	Cap Assembly	\$12.63
9516-412	K4 12° Plate	\$2.03
9155	2T Body	\$1.58
9306-109	7/64" #14 Green 2TN Nozzle	\$0.46
9306-125	1/8" #16 Red 2TN Nozzle	\$0.46
9306-141	9/64" #18 Gold 2TN Nozzle	\$0.46
9316	1/2" MNPT x Male Acme Adapter	\$1.30
9466	3/4" MNPT x Male Acme Adapter	\$1.30



NELSON ROTATOR® ACCESSORIES

STREAM SPLITTERS

Part No.	Description	Price
11285	R10 ONE-SIDED STREAM SPLITTER (RED)	\$0.63
11275	R10 TWO-SIDED STREAM SPLITTER (BLUE)	\$0.83
12057	R2000 STREAM SPLITTER LEGACY (OLD STYLE)	\$1.67
12056	R2000 STREAM SPLITTER (NEW STYLE)	\$1.67

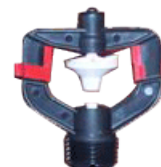

ROAD GUARDS

Part No.	Description	Price
9590-030	R10, R2000(WF) Low Angle (Legacy Road Guard) (Red)	\$4.42
9879	R10, R2000(WF) High Angle (Legacy Road Guard) (Orange)	\$4.42
12213-001	New Style Road Guard (Orange)	\$7.00



TOOLS

Part No.	Description	Price
12050	R10, R2000(WF) 2TN Nozzle Removal Tool	\$10.24
9620	R2000(WF) Plate Removal Tool	\$30.77
9210	R2000(WF) Flush Tool	\$8.89
10689	R2000(WF) Cap Removal Tool	\$30.08
12260	2tn Nozzle Removal Tool	\$25.37
9895-001	Web Guard	\$0.36



INLET ADAPTERS ONLY

Part No.	Description	Price
9465	Male Acme x 3/8" MNPT	\$1.30
9316	Male Acme x 1/2" MNPT	\$1.30
9466	Male Acme x 3/4" MNPT	\$1.34
10060-001	Male Acme x 1/2" PVC Slip	\$1.11
10060-002	Male Acme x 3/4" PVC Slip	\$1.11



MISCELLANEOUS

Part No.	Description	Price
10045	Internal Locking Device	\$0.91
9895-001	R2000 Web Guard	\$0.36
10615	Thread Cap Shut-off for Acme Adapters	\$0.87
10352	Female Acme x 1/2" PVC Spigot	\$0.89
10367	Pressure Gauge Tap Assembly - Gauge Not Included	\$11.41



NELSON R33 / R33LP ROTATOR®

NEW SPRINKLER

COMPLETE R33 / R33LP ASSEMBLY

Part No.	Description	Price
11466-10XX	R33 COMPLETE CAP/BODY/NOZ/ADAP	\$24.46
11466-11XX	R33LP COMPLETE CAP/BODY/NOZ/ADAP	\$24.46

Note: Sprinkler is supplied unassembled unless assembly is ordered.



R33 / R33LP COMPONENTS

Part No.	Description	Price
11344	R33 ADAPTER	\$1.95
11161-001	R33/R33LP FLUSH TOOL - SHORT	\$4.95
11161-002	R33/R33LP FLUSH TOOL - LONG	\$4.95
11363	R33-R33LP ROAD GUARD	\$10.10
11473	33TN NOZZLE REMOVAL TOOL	\$22.88
11478	DIFFUSER/MOTOR INSTALL/REMOVE TOOL	\$22.88
11417	R33/R33LP KEEPER	\$0.60
11344-001	R33 ADAPTER WITH KEEPER INSTALLER	\$2.94

R33 / R33LP Performance (U.S Units)			R33LP Performance Range 25-50 PSI										
			R33 Performance Range 40-65 PSI										
Plate	Part Number	Description	Pressure in PSI										
			25	30	35	40	45	50	55	60	65		
Gold 18 9/64"	R33: 11466-1018	GPM	2.88	3.15	3.40	3.64	3.86	4.07	4.27	4.46	4.65		
	R33LP: 11466-1118	RAD (ft.)	37	38	40	42	43	42	44	42	44	44	44
Brown 20 5/32"	R33: 114466-1020	GPM	3.52	3.85	4.16	4.45	4.72	5.00	5.22	5.45	5.68		
	R33LP: 114466-1120	RAD (ft.)	38	40	42	43	45	43	45	44	45	46	47
Gray 22 11/64"	R33: 11466-1022	GPM	4.24	4.64	5.02	5.37	5.70	6.01	6.30	6.57	6.83		
	R33LP: 11466-1122	RAD (ft.)	39	41	44	44	46	44	47	44	47	47	48
Green 24 3/16"	R33: 11466-1024	GPM	5.00	5.50	5.96	6.38	6.78	7.16	7.52	7.85	8.18		
	R33LP: 11466-1124	RAD (ft.)	41	43	45	46	49	46	49	46	50	50	50
Maroon 26 13/64"	R33: 11466-1026	GPM	5.90	6.50	7.05	7.55	8.00	8.45					
	R33LP: 11466-1126	RAD (ft.)	43	45	46	47	-	47	-	47	-		

Radius in feet. Measured indoors in no wind with plates mounted 18 inches above collection cups. The absence of data for a particular model/plate/nozzle combination indicates the pressure is outside the recommended range.



AG - NELSON FEEDTUBE ASSEMBLIES

One of the most common ways to install D10, S10, R10 Series or R2000 Series Product is on a PVC riser extending from a permanent, often buried, lateral pipeline. However, because this is not always desirable considering cost, convenience, portability requirements and a host of other related issues, Nelson has developed several feedtube options. These versatile stake mounting options feature durable UV and kink resistant flexible PVC tubing. They provide for fast and simple installation, easy nozzle cleaning (kink the tubing to stop the flow), and low cost with a high value. The FT1 and FT2 feedtube assemblies are for use with the R10 due to the small .19" ID feedtube used in the assembly, which prohibits higher flow products. The FT4 and FT5 feedtube assemblies utilize a larger .37" ID flexible PVC feedtube and should be used for products requiring nozzle size #65 or larger. FT4 and FT5 feedtube assemblies connect R10 Series, R2000 Series, S10 and D10 products to polyethylene laterals. FT4 is for permanent connection and FT5 has a quick connect and disconnect feature for portable lateral systems. Both assemblies are mounted with steel stakes. With the addition of collar #9195 to FT4 and FT5, they can be converted to mount on a 3/4" PVC stake. Please call us if you have any questions which relate to these fine products.

FT1 FEEDTUBE ASSEMBLY FOR THE R10 #9308-030

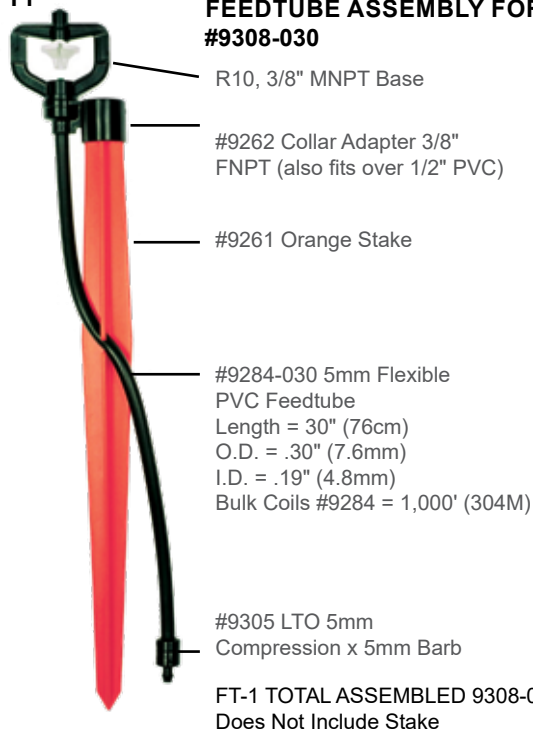

FT2 FEEDTUBE ASSEMBLY FOR THE R10 #9741-030



FT4 FEEDTUBE ASSEMBLY FOR THE R10, R10 TURBO, R2000, R2000WF, S10 & D10 #9752-036



FT5 FEEDTUBE ASSEMBLY FOR THE R10, R10 TURBO, R2000, R2000WF, S10 & D10 #9737-048

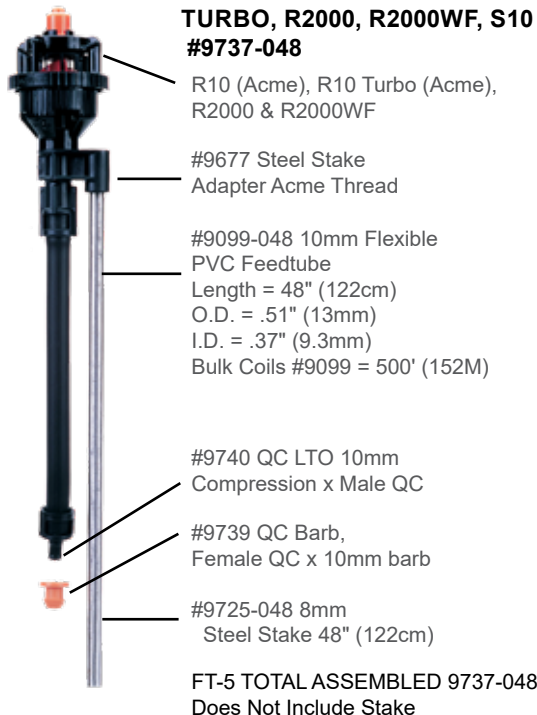

RAIN BIRD® FULL CIRCLE SPRINKLERS

RAIN BIRD® LF800 FULL CIRCLE PLASTIC IMPACTS

Part No.	Nozzle Options	Deflector / Height	Radius/Flow @ 40 PSI	Price
LF08NXXZYY	White, 50 Drill .070"	6° Yellow / 12" - 21"	25' / .89 GPM	\$12.25
LF08NXXZYY	Blue, 5/64"	9° Purple / 16" - 30"	28' / 1.12 GPM	
LF08NXXZYY	Orange, 44 Drill .086"	12° Copper / 27" - 41"	32' / 1.35 GPM	
LF08NXXZYY	Blue, 5/64"	15° Brown / 32" - 50"	31' / 1.12 GPM	



RAIN BIRD® LF1200 FULL CIRCLE PLASTIC IMPACTS

Part No.	Nozzle Options	Deflector / Height	Radius/Flow @ 40 PSI	Price
LF12NXXZYY	Orange, 44 Drill .086"	6° Dark Purple / 14" - 24"	26' / 1.35 GPM	\$12.63 - \$13.76
LF12NXXZYY	Blue, 5/64" .078"	10° White / 19" - 34"	26' / 1.12 GPM	
LF12NXXZYY	Orange, 44 Drill .086"	12° Canyon Blue / 28" - 40"	29' / 1.35 GPM	
LF12NXXZYY	Green, 7/64" .109"	12° Pink / 30" - 44"	34' / 2.15 GPM	
LF12NXXZYY	Purple, 3/32" .094"	16° Red / 39" - 59"	30' / 1.12 GPM	
LF12NXXZYY	Yellow, 38 Drill .102"	17° Powder Blue / 41" - 61"	36' / 1.89 GPM	
LF12NXXZYY	Yellow, 38 Drill .102"	21° Olive Green / 50" - 73"	36' / 1.89 GPM	



RAIN BIRD® LF2400 FULL CIRCLE PLASTIC IMPACTS

Part No.	Nozzle Options	Deflector / Height	Radius/Flow @ 40 PSI	Price
LF24NXXZYY	Tan, 30 Drill .117"	10° Lime / 24" - 41"	33' / 2.53 GPM	\$12.63 - \$13.76
LF24NXXZYY	Tan, 30 Drill .117"	13° Maroon / 30" - 50"	35' / 2.53 GPM	
LF24NXXZYY	Red, 1/8" .125"	15° Tangerine / 28" - 55"	37' / 2.89 GPM	
LF24NXXZYY	Black, 29 Drill .133"	22° Dk. Green / 59" - 102"	42' / 3.25 GPM	
LF24NXXZYY	Silver, 9/64" .143"	22° Dk. Green / 59" - 102"	44' / 3.78 GPM	



XX = Deflector Angle Z = First Letter of Deflector Color YY = Nozzle Size
 All LF Series are 1/2" MIPT, Unless Designated as Acme Bodies by Changing the N in the Part No. to a A.
 Various Nozzle - Deflector Combinations are Available to Achieve the Flow & Radius that you need.
 The information included in the tables above, show radius and flow information with randomly selected
 nozzle and deflector combination operated at 40 PSI.
 Call for Performance Charts. Edge Guard, Splash Guard, Stream Splitter and Other Accessories Available.

RAIN BIRD® FULL CIRCLE IMPACTS

Part No.	Description	Price
A01811	14DH Plastic Body & Arm 1/2" Male Single Nozzle 22°	Call
A01619	14 VH Wedge Drive 1/2" Male Brass Single Nozzle 23°	\$27.50
A06240	L20VH Wedge Drive 1/2" Male Brass Single Nozzle 10°	\$28.93
A06015	L20H 1/2" Male Brass Single Nozzle 23°	\$29.09
A05840	20JH 1/2" Male Brass Single Nozzle 23°	\$26.09
A0231108	20ADJB08 1/2" Male Brass w/ Distance Control Diffuser Pin w/ Noz.	\$40.28
A06501	29JH 1/2" Male Brass Single Nozzle 23°	Call
A07360	L36H 3/4" Male Plastic w/ Brass Brg. Sleeve, Slotted Spoon 10°	\$35.53
A07350	L36AH 3/4" Male Plastic w/ Brass Brg. Sleeve, Regular Spoon 10°	\$28.19
A11640	L3030H 3/4" Male Brass Double Nozzle 10°	\$56.86
L46000	46H 3/4" Male Plastic Double Nozzle 23°	Call
A08401	30H 3/4" Male Brass Double Nozzle 27°	\$44.12
A08411	30WH 3/4" Male Brass Single Nozzle 27°	\$45.23
A11355	30PWH 3/4" Male Brass Aluminum Arm, Single Nozzle 27°	Call
A12800	14070H 3/4" Male Brass Double Nozzle 27°	\$68.52
A08401F	30FH 3/4" Male Brass Frost Protection, Double Nozzle 27°	\$44.12
A08901F	30FWH 3/4" Male Brass Frost Protection, Single Nozzle 27°	\$45.23
A20000	70CH 1" Female Brass Double Nozzle 21°	\$198.96
A20030	70CHM 1" Male Brass Double Nozzle 21°	Call
A23802	80EHD 1-1/4" Male Brass Double Nozzle 27°	Call



Less Nozzle Unless Noted

FULL CIRCLE IMPACT SPRINKLERS

NELSON FULL CIRCLE IMPACTS (LIMITED QTY)

Part No.	Description	Price
6902	F33AS 3/4" Male Brass Single Nozzle 15°	\$67.81
6717	F33AA 3/4" Male Brass Double Range Nozzle 15°	\$89.56
6903	F43A 3/4" Male Brass Double Nozzle 15°	\$134.00
7316	F70M 1" Male Brass Double Nozzle 25°	\$291.00

Less Nozzle



WADE RAIN FULL CIRCLE BRASS IMPACTS

Part No.	Description	Price
WR-33-P	3/4" Male Single Nozzle x Plug	\$23.38
WR-33	3/4" Male Range Nozzle x Spreader Nozzle	\$23.28
WR-32-P	3/4" Male Single Nozzle x Plug	\$24.48
WR-32	3/4" Male Range Nozzle x Spreader Nozzle	\$24.48

Less Nozzle



XCAD AQUA BURST® FULL CIRCLE IMPACTS

Part No.	Description	Nozzle Guide	Price
HF30	3/4" Male Brass Single Nozzle 25°	NOZ75	\$23.16
HF30D	3/4" Male Brass Double Nozzle 25°	NOZ75	\$24.48
HF30AL-C	3/4" Male Brass Aluminum Arm Single Nozzle 25°	NOZ75	\$23.76
AL30-C	3/4" Brass Brg., Plastic Body, Alum. Arm Dbl. Noz. 25°	NOZ75	\$19.00

Less Nozzle



PART OR FULL CIRCLE IMPACT SPRINKLERS

RAIN BIRD® PART OR FULL CIRCLE IMPACTS

Part No.	Description	Price
B46100-08	2045-PJ-AG 1/2" Male Plastic Impact with 1/8" Nozzle	\$16.21
A34403-10	25BPJ-FP-ADJ-DA-TNT 1/2" Male Brass Impact, PJ Arm, with Diffuser & Distance Control and 5/32" Nozzle	\$54.37
A32901-XX	25B-PJ-FP-ADJ 1/2" Male Brass Impact with PJ Arm, Adjustable Breakup Pin, and SBN Nozzle	\$44.45 - \$47.29
A39200	35A-TNT 3/4" Male Brass Impact Less Nozzle	\$84.55
A4061312	35A-PJ-ADJ-TNT 3/4" Male Brass Impact with PJ Arm & ADJN-3 #12 (3/16") Nozzle	\$89.29
AG2001	65PJ-TNT 1" Female Brass Impact with PJ Arm, Less Nozzle	\$256.62
A23600	85EHD 1-1/4" Male Brass Impact, Less Nozzles 27°	\$402.04
A23960	85EHD-LA 1-1/4" Male Brass Low Angle Impact, Less Nozzle 17°	Call



XCAD AQUA BURST® PART OR FULL CIRCLE IMPACTS

Part No.	Description	Price
X65ED	1" Male Brass Impact without Nozzle 24°	\$168.12



NELSON PART OR FULL CIRCLE BRASS IMPACTS

Part No.	Description	Price
8805	P65M 1" Male Single Nozzle 24°	\$433.00
8426	P85 1-1/4" Male Double Nozzle 24°	\$706.00
8079	P85AS 1-1/4" Male Single Nozzle 18°	\$646.00
7697	P85A 1-1/4" Male Double Nozzle 18°	\$683.00

Less Nozzle



NELSON NOZZLES, VANES & ACCESSORIES

Part No.	Description	Price
2RN	Brass Nozzle for L20-04T	Call
3RN	Brass Nozzle for 3/4" Impacts	Call
2FCN	Flow Control Nozzle for L20-04T	Call
3FCN	Flow Control Nozzle for F33AS, F33AA & F44AAB	\$9.65
7RN	Drive Nozzle F70M, F70AM & P65M	\$8.42
8DRN	Drive Nozzle F80, F80A, P85, P85A & P85AS	\$20.60
3RNPLUG	Brass Secondary Plug for F70A, F80A, P85, F44AAB	\$3.19
3V	Stream Straightener for F33AS & F33AA	Call
4V	Stream Straightener for F44AAB & F43A	Call
7V	Stream Straightener for F70M, F70AM & P65M	\$1.63
8V	Stream Straightener for all 80 & 85 Series Impacts	\$1.74
8ADN	Adjustable Diffuser Assembly (Including Nozzle)	\$111.89
8DN	Diffuser Assembly Only (No Nozzle)	\$91.29
7198	F70 1" FC Bearing Assembly	\$127.31
7197	F80 1-1/4" FC Bearing Assembly	\$270.96
8806	P65 1" PC Bearing Assembly	\$143.66
9036	P85 1-1/4" PC Bearing Assembly	\$490.50
7714	P85A & P85AS 1-1/4" PC LA Bearing Assembly	\$354.37



RAIN BIRD® NOZZLES & ACCESSORIES

Part No.	Description	Price
100225-xx	LAN-1-7 Brass 7° Low Angle Nozzle 1/2" Body	\$1.59 - \$1.75
100226-xx	LAN-1-20 Brass 20° Low Angle Nozzle 1/2" Body & Spreader Nozzle for 3/4" Bodies & 808A	\$1.40 - \$1.75
105780-xx	SBN-1 Brass Straight Bore Nozzle for 1/2" Body	\$0.95 - \$0.98
106160-xx	SBN-1V Brass Straight Bore Nozzle w/Vane for 1/2" Body	\$1.18 - \$1.29
105842-xx	SBN-3 Brass Straight Bore Nozzle for 3/4" Body	\$2.36 - \$2.60
106131-xx	SBN-3V Brass Straight Bore Nozzle w/Vane for 3/4" Body	\$1.92 - \$2.11
100382-xx	SBN-4 Brass Straight Bore Nozzle for 1" Body	\$7.45 - \$9.31
103043-xx	SBN-5 Brass Straight Bore Nozzle for 1-1/4" Body	\$19.33
100418	SPB-1 Spreader Bushing for 1" Body	\$6.99
105816	NV-3 Nozzle Vane for 3/4" Body	\$0.54
101092-xx	ADJN-1V Brass Adjustable Nozzle w/Vane for 1/2" Body	Call
100328-xx	ADJN-3 Brass Adjustable Nozzle for 3/4" Body	\$12.94
100385-xx	ADJN-4 Brass Adjustable Nozzle for 1" Body	\$24.86
100332-xx	DAN-3 Brass Do-All Nozzle for 3/4" Body	\$23.61
100255	Brass Plug for 1/2" Body	\$1.22
100289	Brass Plug for 3/4" Body (Range)	\$2.13
100417	Brass Plug for 1" Body (Spreader Side)	\$6.39
104792	1/2" FC Bearing Assembly for 14DH	Call
104189	1/2" FC Bearing Assembly for 14VH	Call
118343	1/2" FC Bearing Assembly for L20VH	Call
104695	1/2" FC Bearing Assembly for 20JH, L20H	Call
104919	1/2" FC Bearing Assembly for 29JH	Call
105833	3/4" FC Bearing Assembly for 46H	Call
104152	3/4" FC Bearing Assembly for 30H, 14070H	Call
110048	3/4" FC Bearing Assembly for 30TNT	Call
104041	1" FC Bearing Assembly for 70CH Female	Call
108726	1" FC Bearing Assembly for 70CH Male	Call
104640	1-1/4" FC Bearing Assembly for 80EH	Call
106181	1/2" PC Bearing Assembly for 25BPJ-FP-ADJ	Call
110581	3/4" PC Bearing Assembly for 35A-TNT	Call
106297	1" PC Bearing Assembly for 65PJ-TNT	Call
111136	1-1/4" PC Bearing Assembly for 85EHD, 85EHD-LA	Call



XCAD AQUA BURST® NOZZLES & ACCESSORIES

Part No.	Description	Price
NOZ5R	Brass Straight Bore Nozzle for 1/2" Impacts Fits Aqua Burst® AB20 Series	\$0.84
NOZ5W	Brass Straight Bore Nozzle for 1/2" Impacts Fits Aqua Burst® RB Series	\$0.84
NOZ75	Brass Straight Bore Nozzle for 3/4" Impacts Including 1/2" Aqua Burst® RB29F	\$0.96
NOZ1	Brass Straight Bore Nozzle for 1" Impacts	\$3.96
NOZ-BKSPRD	Brass Spreader Nozzle 1/8" NPT (3/32" or 1/8")	\$0.96
NOZ-PLG18	Brass Plug 1/8" NPT	\$0.96
NOZ-PLG25	Brass Plug 1/4" NPT	\$0.96
X65BRNG	Brass Bearing Assembly for 1" Impacts	\$51.70



SPRINKLER RISERS

GALVANIZED RISERS

Part No.	Size	Length	Price
9-8-6S	1" MIPT x 3/4" FIPT	6"	Call
9-8-12S		12"	Call
9-8-18S		18"	Call
9-8-24S		24"	Call
9-8-30S		30"	Call
9-8-36S		36"	Call

ALUMINUM RISERS

Part No.	Size	Length	Price
9-8-6A	1" MIPT x 3/4" FIPT	6"	Call
9-8-12A		12"	Call
9-8-18A		18"	Call
9-8-24A		24"	Call
9-8-30A		30"	Call
9-8-36A		36"	Call



WEBSTER MATIC QUICK CONNECT RISERS WITH INTERNAL VALVE

Part No.	Description	Price
WM-6-075-AG-FIPT	3/4" Webster AG Valve x 3/4" FIPT w / ball	\$15.54
WM-6-075-AG-FPTLB	3/4" Webster AG Valve x 3/4" FIPT less ball	\$14.05
WM-6-075-AG-MIPT	3/4" Webster AG Valve x 1" MIPT w / ball	\$15.54
WM-6-075-AG-MPTLB	3/4" Webster AG Valve x 1" MIPT less ball	\$14.05
WM-6-075-LW-FIPT	3/4" Webster Lawn Valve x 3/4" FIPT w / ball and lid	\$22.34
WM-6-075-LW-FPTLB	3/4" Webster Lawn Valve x 3/4" FIPT less ball w / lid	\$20.86
WM-6-075-LW-MIPT	3/4" Webster Lawn Valve w / 1" MIPT w / ball & lid	\$22.34
WM-6-075-LW-MPTLB	3/4" Webster Lawn Valve x 1" MIPT less ball w / lid	\$20.86
WM-6-100-AG-MIPT	1" Webster AG Valve x 1" MIPT w / ball	\$17.22
WM-6-100-AG-MPTLB	1" Webster AG Valve x 1" MIPT less ball	\$15.12
WM-6-100-LW-MIPT	1" Webster Lawn Valve x 1" MIPT w / ball & lid	\$21.36
WM-6-100-LW-MPTLB	1" Webster Lawn Valve x 1" MIPT less ball w / lid	\$19.26
WM-6-100-FIW-AG-F	1" Webster Valve x 1" FIPT w / ball	\$17.14
WM-6-100-FIW-AG-M	1" Webster Valve x 1" Steel MIPT / O-ring w / ball	\$19.91
WM-6-125-AG-FIPT	1-1/4" Webster AG Valve x 1" FIPT w / ball	\$19.20
WM-6-125-AG-FPTLB	1-1/4" Webster AG Valve x 1" FIPT less ball	\$19.07
WM-6-125-AG-MIPT	1-1/4" Webster AG Valve x 1 1/4" MIPT w / ball	\$21.53
WM-6-125-AG-MPTLB	1-1/4" Webster AG Valve x 1 1/4" MIPT less ball	\$19.04
WM-6-125-LW-FIPT	1-1/4" Webster Lawn Valve x 1" FIPT w / ball & lid	\$26.34
WM-6-125-LW-FPTLB	1-1/4" Webster Lawn Valve x 1" FIPT less ball w / lid	\$23.88
WM-6-125-LW-MIPT	1-1/4" Webster Lawn Valve x 1 1/4" MIPT w / ball & lid	\$26.34
WM-6-125-LW-MPTLB	1-1/4" Webster LAWN VLV x 1 1/4" MIPT less ball w / lid	\$23.88
WM-8-100-WDC-FIPT	1" Webster VLV x 1" FIPT w / IVA inner valve assembly w / ball	\$22.03
WM-8-100-WDC-MIPT	1" Webster VLV x 1" MIPT IVA inner valve assembly	\$26.46
WM-CS-075	3/4" Webster collar & screw	\$4.98
WM-CS-100	1" Webster collar & screw	\$4.79
WM-CS-125	1-1/4" Webster collar & screw	\$6.05
WM-CSD-100	1" Webster double collar & screw	\$6.97
WM-GS-075	3/4" Webster gasket	\$1.68
WM-GS-100	1" Webster gasket	\$1.80
WM-GS-125	1-1/4" Webster gasket	\$2.46
WM-VB-075	3/4" Webster Valve ball	\$1.49
WM-VB-100	1" Webster Valve ball	\$2.10
WM-VB-125	1-1/4" Webster Valve ball	\$2.46
WM-VO-075	3/4" Webster valve opener	\$1.32
WM-VO-100	1" Webster valve opener	\$1.87
WM-VO-125	1-1/4" Webster valve opener	\$2.08



SENNINGER® FULL CIRCLE PLASTIC IMPACT SPRINKLERS

SENNINGER® PIVOT MASTER FULL CIRCLE IMPACTS - 6°

Part No.	Description	Price
3006H-1-3/4"-M-PM	3/4" Male Single Noz. 6° w/Brass Swivel (Less Noz.)	\$25.00
4006H-1-3/4"-M-PM	3/4" Male Single Noz. 6° w/Brass Swivel (Less Noz.)	\$25.00
5006H-1-3/4"-M-PM	3/4" Male Single Noz. 6° w/Brass Swivel (Less Noz.)	\$25.00
4006H-2-3/4"-M-PM	3/4" Male Double Noz. 6° w/Brass Swivel (Less Noz.)	\$25.00
5006H-2-3/4"-M-PM	3/4" Male Double Noz. 6° w/Brass Swivel (Less Noz.)	\$25.00



SENNINGER® PIVOT MASTER FULL CIRCLE IMPACTS - 12°

Part No.	Description	Price
3012H-1-3/4"-M-PM	3/4" Male Single Noz. 12° w/Brass Swivel (Less Noz.)	\$25.00
4012H-1-3/4"-M-PM	3/4" Male Single Noz. 12° w/Brass Swivel (Less Noz.)	\$25.00
5012H-1-3/4"-M-PM	3/4" Male Single Noz. 12° w/Brass Swivel (Less Noz.)	\$25.00
7012SD-2-1"-F	1" Female Double Noz. 12° w/Plastic Swivel (Less Noz.)	\$60.00
7012SD-2-1"-M	1" Male Double Noz. 12° w/Plastic Swivel (Less Noz.)	\$60.00



SENNINGER® FULL CIRCLE - SINGLE NOZZLE IMPACTS - 23° & 25°

Part No.	Description	Price
2023HS-1-1/2"-M	1/2" Male Single Noz. 23° (Less Noz.)	\$8.50
3023-1-3/4"-M	3/4" Male Single Noz. 23° (Less Noz.)	\$12.00
4023-1-3/4"-M	3/4" Male Single Noz. 23° (Less Noz.)	\$12.00
5023-1-3/4"-M	3/4" Male Single Noz. 23° (Less Noz.)	\$12.00
7025RD-1-1"-M	1" Male Single Noz. 25° (Less Noz.)	\$60.00
8025HR-1-1-1/4"-M	1-1/4" Male Single Noz. 25° (Less Noz.)	\$144.00



SENNINGER® FULL CIRCLE - DOUBLE NOZZLE IMPACTS - 23° & 25°

Part No.	Description	Price
3023-2-3/4"-M	3/4" Male Double Noz. 23° (Less Noz.)	\$14.00
4023-2-3/4"-M	3/4" Male Double Noz. 23° (Less Noz.)	\$14.00
5023-2-3/4"-M	3/4" Male Double Noz. 23° (Less Noz.)	\$14.00
7025RD-2-1"-M	1" Male Double Noz. 25° (Less Noz.)	\$62.50
8025HR-2-1-1/4"-M	1-1/4" Male Double Noz. 25° (Less Noz.)	\$144.00



SENNINGER® NOZZLES, VANES & ACCESSORIES

Part No.	Description	Price
NZINXX	Noz. for 20, 30, 40 & 50 Series Impacts #6 - #18 (3/32" - 9/32") & Spreader Noz. for 70 & 80 Series #7 - #18 (7/64" - 9/32")	\$0.75
NZVXX	Nozzle - Vane Combination #6 - #10 (3/32" - 5/32") for 20, 30 & 40	\$1.20
HTNZV05	Hand-Tight Nozzle-Vane w/ O-ring, color-coded sizes #5-18 (5/64" - 9/32") for: 20, 30, 40 and 50 Impact Sprinklers	\$2.00
HTNZV05Q	Hand-Tight, Square Orifice Nozzle-Vane w/ O-ring, color-coded sizes #5-10 (5/64" - 5/32") for: 20, 30, 40 and 50 Impact Sprinklers	\$2.00
HTNZPLUG	Hand-Tight Nozzle Plug (Black)	\$2.00
70NZXX	Range Noz. for 70 Series #14 - #24 (7/32" - 3/8")	\$2.50
80NZXX	Range Noz. for 80 Series #24 - #40 (3/8" - 5/8")	\$4.00
VNW	White Regular Vane (Maximizes Throw)	\$0.60
VNR	Red Spiral Vane (Improves Uniformity at Low Pressure)	\$0.60
VNB	Blue Barrel Vane (Large Passageway to Reduce Clogging)	\$0.60
VN72	Blue-Green Range Noz. Vane for 70 Series (Maximizes Throw)	\$2.00
VN75E	Pink Range Noz. Vane for 70 Series (Effluent Vane, Large Passage)	\$2.00
VN85	Black Range Noz. Vane for 80 Series (Large Passageway, Minimizes Clogging)	\$4.00
80NEX	Range Nozzle Extension, 8025SD-2	\$6.00



SENNINGER® PART CIRCLE PLASTIC IMPACT SPRINKLERS

MODEL 3123 (NOZZLES #8 - #10)

Part No.	Description	Price
3123PC-1-3/4"M	3/4" Male Plastic Swivel (Less Noz.)	\$30.00
3123PC-1-3/4"F	3/4" Male Plastic Swivel with 3/4" Coupling (Less Noz.)	\$30.00
3123PC-1-1"F	3/4" Male Plastic Swivel with 1" x 3/4" Coupling (Less Noz.)	\$30.00



MODEL 4123 (NOZZLES #10 - #13)

Part No.	Description	Price
4123PC-1-3/4"M	3/4" Male Plastic Swivel (Less Noz.)	\$30.00
4123PC-1-3/4"F	3/4" Male Plastic Swivel with 3/4" Coupling (Less Noz.)	\$30.00
4123PC-1-1"F	3/4" Male Plastic Swivel with 1" x 3/4" Coupling (Less Noz.)	\$30.00



MODEL 5123 (NOZZLES #13 - #18)

Part No.	Description	Price
5123PC-1-3/4"M	3/4" Male Plastic Swivel (Less Noz.)	\$30.00
5123PC-1-3/4"F	3/4" Male Plastic Swivel with 3/4" Coupling (Less Noz.)	\$30.00
5123PC-1-1"F	3/4" Male Plastic Swivel with 1" x 3/4" Coupling (Less Noz.)	\$30.00

SENNINGER® 23° EFFLUENT® IMPACTS

SENNINGER® FULL CIRCLE - SINGLE NOZZLE EFFLUENT® IMPACTS (FOR WASTEWATER)

Part No.	Description	Price
3023-1-3/4F-EFF	3/4" Female, Full Circle, Plastic Base, Nozzle Range 7-10 (Less Noz.)	\$12.00
3023-1-3/4M-EFF	3/4" Male, Full Circle, Plastic Base, Nozzle Range 7-10 (Less Noz.)	\$12.00
4023-1-3/4F-EFF	3/4" Female, Full Circle, Plastic Base, Nozzle Range 10-14 (Less Noz.)	\$12.00
4023-1-3/4M-EFF	3/4" Male, Full Circle, Plastic Base, Nozzle Range 10-14 (Less Noz.)	\$12.00
5023-1-3/4F-EFF	3/4" Female, Full Circle, Plastic Base, Nozzle Range 13-18 (Less Noz.)	\$12.00
5023-1-3/4M-EFF	3/4" Male, Full Circle, Plastic Base, Nozzle Range 13-18 (Less Noz.)	\$12.00
7025-1-1F-EFF	1" Female, Full Circle, Plastic Base, Nozzle Range 14-24 (Less Noz.)	\$60.00
7025-1-1M-EFF	1" Male, Full Circle, Plastic Base, Nozzle Range 14-24 (Less Noz.)	\$60.00
8025-1-1.25F-EFF	1-1/4" Female, Full Circle, Plastic Base, Nozzle Range 24-40 (Less Noz.)	\$144.00
8025-1-1.25M-EFF	1-1/4" Male, Full Circle, Plastic Base, Nozzle Range 24-40 (Less Noz.)	\$144.00



NELSON BIG GUN SPRINKLERS

Part No.	Description	Price
10279-121	F 75 x 21° x 2" Full Circle w/HD Lower Bearing	\$887.00
10279-124	F 75 x 24° x 2" Full Circle w/HD Lower Bearing	\$887.00
10229-118	SR 75 x 18° x 2" Part Circle w/HD Lower Bearing	\$1,105.00
10229-121	SR 75 x 21° x 2" Part Circle w/HD Lower Bearing	\$1,105.00
10229-124	SR 75 x 24° x 2" Part Circle w/HD Lower Bearing	\$1,105.00
8211-038	F 100 x 18° x 2" Full Circle	\$903.00
8211-042	F 100 x 21° x 2" Full Circle	\$903.00
8211-046	F 100 x 24° x 2" Full Circle	\$903.00
8211-147	QC-F100 x 24° Full Circle w/Integral Valve Key	\$2,385.00
8211-098	SR 100 x 18° x 2" Part Circle	\$1,385.00
8211-102	SR 100 x 21° x 2" Part Circle	\$1,385.00
8211-106	SR 100 x 24° x 2" Part Circle	\$1,385.00
8211-143	QC-SR100 x 24° Part Circle w/Integral Valve Key	\$2,987.00
8211-110	SRNV 100E x 18° Part Circle w/Solenoid	\$2,109.00
9643	SRNV 100H x 18° x 2" Part Circle w/out Solenoid	\$1,921.00
9455-021	F150 x 21° Full Circle - Flanged Connection	\$1,767.00
9455-024	F150 x 24° Full Circle - Flanged Connection	\$1,767.00
8463-221	SR150 x 21° Part Circle - Flanged Connection	\$2,197.00
8463-224	SR150 x 24° Part Circle - Flanged Connection	\$2,197.00
9292-001	SR150 x 43° Part Circle - Flanged Connection	\$2,393.00
10055-001	SRA150 Adjustable Trajectory - Flanged Connection	\$2,997.00
6080	F200 x 21° Full Circle - Flanged Connection	\$2,918.00
6260	F200 x 24° Full Circle - Flanged Connection	\$2,918.00
6000	F200 x 27° Full Circle - Flanged Connection	\$2,918.00
9192-021	SR200 x 21° Part Circle - Flanged Connection	\$4,215.00
9192-024	SR200 x 24° Part Circle - Flanged Connection	\$4,215.00
9192-027	SR200 x 27° Part Circle - Flanged Connection	\$4,215.00
(1)	for Anodized F100 or SR100 add	Call
(2)	for Anodized & Powder Coated F100 or SR100 add	Call
(3)	for Anodized F150 or SR150 add	Call
(4)	for Anodized & Powder Coated F150 or SR150 add	Call
(5)	for Anodized SR200 add	Call
(6)	for Anodized & Powder Coated SR200 add	Call



Coating options not available for F200.

TRAJECTORIES AVAILABLE

Big Gun®	Trajectory Angle
75 SERIES	21°, 24°, 43°
100 SERIES	18°, 21°, 24°, 43°
150 SERIES	21°, 24°, 27°, 43°, 15°-45° Adjustable
200 SERIES	21°, 24°, 27°

CONNECTIONS AVAILABLE

Big Gun®	Size Connections
75 SERIES	1-1/2", 2" FNPT, ANSI/DIN, Nelson, Metric, 2-1/2" FNPT
100 SERIES	2" or 2 1/2" FNPT & ANSI/DIN, Nelson, Metric
150 SERIES	3" or 3 1/2" Fem. x Flange & ANSI/DIN, Nelson, Metric
200 SERIES	3" or 4" Fem. x Flange & ANSI/DIN, Nelson, Metric



NELSON BIG GUN® NOZZLES

75 SERIES TAPER RING

Part No.	Size	Price
10208-040	.40"	\$22.75
10208-045	.45"	\$22.75
10208-050	.50"	\$22.75
10208-055	.55"	\$22.75
10208-060	.60"	\$22.75
10208-065	.65"	\$22.75
10208-070	.70"	\$22.75
10208-075	.75"	\$22.75
10208-080	.80"	\$22.75
10207	Noz. Cap Only	\$34.36



100 SERIES TAPER BORE NOZZLES

Part No.	Size	Price
9309-050	.50"	\$51.95
9309-055	.55"	\$51.95
9309-060	.60"	\$51.95
9309-065	.65"	\$51.95
9309-070	.70"	\$51.95
9309-075	.75"	\$51.95
9309-080	.80"	\$51.95
9309-085	.85"	\$51.95
9309-090	.90"	\$51.95
9309-100	1.0"	\$51.95



100 SERIES RING NOZZLES

Part No.	Description	Price
6749	100R Ring Nozzle Set	\$130.00
7872	Ring Nozzle Cap Only (use only with 100R)	\$22.06
6745	Ring Nozzle Cap Only (use only with 100TR)	\$20.74
9956-001	Ring or Taper Ring Nozzle Body Only	\$48.30
6847	Set of 7 Rings Only	\$63.95
6738-060	R100 .60" Individual Ring Only	\$9.20
6738-071	R100 .71" Individual Ring Only	\$9.20
6738-077	R100 .77" Individual Ring Only	\$9.20
6738-081	R100 .81" Individual Ring Only	\$9.20
6738-086	R100 .86" Individual Ring Only	\$9.20
6738-089	R100 .89" Individual Ring Only	\$9.20
6738-093	R100 .93" Individual Ring Only	\$9.20
6738-096	R100 .96" Individual Ring Only	\$9.20

Note: Contact Factory for Pricing and Availability of Anodized and Anodized & Powder Coated.



100 SERIES TAPER RINGS

Part No.	Description	Price
9237-016	TR100 .63" Individual Taper Ring 16MM	\$22.96
9237-017	TR100 .67" Individual Taper Ring 17MM	\$22.96
9237-018	TR100 .71" Individual Taper Ring 18MM	\$22.96
9237-019	TR100 .75" Individual Taper Ring 19MM	\$22.96
9237-020	TR100 .79" Individual Taper Ring 20MM	\$22.96
9237-021	TR100 .83" Individual Taper Ring 21MM	\$22.96
9237-022	TR100 .87" Individual Taper Ring 22MM	\$22.96
9237-023	TR100 .91" Individual Taper Ring 23MM	\$22.96
9237-024	TR100 .95" Individual Taper Ring 24MM	\$22.96



150 SERIES TAPER BORE NOZZLES

Part No.	Description	Price
9317-070	150T .70"	\$88.56
9317-080	150T .80"	\$88.56
9317-090	150T .90"	\$88.56
9317-100	150T 1.0"	\$88.56
9317-110	150T 1.1"	\$88.56
9317-120	150T 1.2"	\$88.56
9317-130	150T 1.3"	\$88.56
9317-140	150T 1.4"	\$88.56



150 SERIES RING NOZZLES

Part No.	Description	Price
6790	150R Ring Nozzle Set	\$214.00
6286	Ring Nozzle Cap Only	\$48.34
9773	Ring Nozzle Body Only	\$79.13
6846	Set of 7 Rings Only	\$128.00
6287-086	R150 .86" Individual Ring Only	\$19.06
6287-097	R150 .97" Individual Ring Only	\$19.06
6287-108	R150 1.08" Individual Ring Only	\$19.06
6287-118	R150 1.18" Individual Ring Only	\$19.06
6287-126	R150 1.26" Individual Ring Only	\$19.06
6287-134	R150 1.34" Individual Ring Only	\$19.06
6287-141	R150 1.41" Individual Ring Only	\$19.06
6287-147	R150 1.47" Individual Ring Only	\$19.06

Note: Contact Factory for Pricing and Availability of Anodized and Anodized & Powder Coated.



NELSON BIG GUN® NOZZLES & ACCESSORIES

150 SERIES TAPER RINGS

Part No.	Description	Price
9238-022	TR150 22MM (.87")	\$28.22
9238-024	TR150 24MM (.95")	\$28.22
9238-026	TR150 26MM (1.02")	\$28.22
9238-028	TR150 28MM (1.10")	\$28.22
9238-030	TR150 30MM (1.18")	\$28.22
9238-032	TR150 32MM (1.26")	\$28.22
9238-034	TR150 34MM (1.33")	\$28.22



200 SERIES TAPER BORE NOZZLES

Part No.	Description	Price
9323-105	200T 1.05"	\$147.00
9323-110	200T 1.10"	\$147.00
9323-120	200T 1.20"	\$147.00
9323-130	200T 1.30"	\$147.00
9323-140	200T 1.40"	\$147.00
9323-150	200T 1.50"	\$147.00
9323-160	200T 1.60"	\$147.00
9323-175	200T 1.75"	\$147.00
9323-190	200T 1.90"	\$147.00



200 SERIES RING NOZZLES

Part No.	Description	Price
6789	200R Ring Nozzle Set	\$314.00
9972-001	Ring Nozzle Body, Only	\$158.00
6026	Ring Nozzle Cap, Only	\$71.80
6845	Set of 7 Rings Only	\$203.00
6027-129	R200 1.29" Individual Ring Only	\$29.14
6027-146	R200 1.46" Individual Ring Only	\$29.14
6027-156	R200 1.56" Individual Ring Only	\$29.14
6027-166	R200 1.66" Individual Ring Only	\$29.14
6027-174	R200 1.74" Individual Ring Only	\$29.14
6027-183	R200 1.83" Individual Ring Only	\$29.14
6027-193	R200 1.93" Individual Ring Only	\$29.14



Note: Contact Factory for Pricing and Availability of Anodized and Anodized & Powder Coated.

100 SERIES HEAVY-DUTY LOWER BEARING

Part No.	Description	Price
7863	2" FNPT Full Circle Bearing Assembly	\$569.00
7864	1-1/2" FNPT Full Circle Bearing Assembly	\$569.00
7862	Flanged Full Circle Bearing Assembly	\$569.00
7273	2" Part Circle Bearing Assembly	\$617.00
7277	2-1/2" Part Circle Bearing Assembly	\$617.00
7753	Flanged Part Circle Bearing Assembly	\$617.00
10265-201	ANSI Flanged, Full Circle Bearing Assembly	\$607.88
10265-104	ANSI Flanged, Part Circle Bearing Assembly	\$617.00
7950	2" FNPT Part Circle Nozzle Valve Bearing Assy.	\$641.00



150 & 200 SERIES LOWER BEARING ASSEMBLY

Part No.	Description	Price
8458	150 Series Lower Bearing Assembly Flg. Conn.	\$1,021.40
10323-001	150 Series Lower Bearing Assembly ANSI Conn.	\$1,021.40
9114-000	200 Series Lower Bearing Assembly Flg. Conn.	\$2,181.41
9114-003	200 Series Lower Bearing Assembly ANSI Conn.	\$2,181.41



BIG GUN® ACCESSORIES

Part No.	Description	Price
8403-001	150 FI 3" FNPT x Flange Adapter	\$124.00
6621-00	200 FI 3 1/2" FNPT x Flange Adapter	\$110.00
9127	200 FI 4" FNPT x Flange Adapter	\$171.00
9724	Secondary Nozzle Kit	\$34.42
9822	SR100 & SR150 Drive Arm Maintenance Kit	\$111.46
9857	SR100 LPV Kit (low pressure drive vane)	\$16.96
6671	600V Stream Straightener Vane (fits 2" x 6" riser)	\$46.35
8386	100 CBK Series Counter Balance Kit	\$411.00
8399	150 CBK Series Counter Balance Kit	\$424.00
11090	75 Drive Arm Maintenance Kit	\$84.92
10088-001	Flange Assembly, 2" FNPT	\$67.77
10088-002	Flange Assembly, 2.5" FNPT	\$84.50
10088-006	Flange Assembly, 1.5" FNPT	\$111.14
10333-001	Flange ASSY, 4" ANSI - HD200	\$350.03





QUICK DISCONNECT "GUN" ADAPTERS

New Part No.	Part No.	Description	Price
5217511-0003	2247-3 FEMALE	Gun Adapter, 3" Female Only, Weld-On	\$167.10
5217511-1502	2247-3F2F	Gun Adapter, 3" Female x 2" FIPT	\$250.65
5217511-1503	2247-3F25F	Gun Adapter, 3" Female x 2.5" FIPT	\$274.80
5217511-1002	2247-3F2M	Gun Adapter, 3" Female x 2" MIPT	\$242.78
5217511-1003	2247-3F25M	Gun Adapter, 3" Female x 2.5" MIPT	\$257.48
5217511-1504	2247-3F3F	Gun Adapter, 3" Female x 3" FIPT	\$291.53
5217511-1004	2247-3F3M	Gun Adapter, 3" Female x 3" MIPT	\$273.30
5217511-0004	2247-4 FEMALE	Gun Adapter, 4" Female Only, Weld-On	\$178.28
5217511-3504	2247-4F4F	Gun Adapter, 4" Female x 4" FIPT	\$347.03
5217511-3004	2247-4F4M	Gun Adapter, 4" Female x 4" MIPT	\$318.30
5217501-0503	2247-3MALE	Gun Adapter, 3" Male Only, Weld-On	\$101.93
5217501-2002	2247-3M2M	Gun Adapter, 3" Male x 2" MIPT	\$165.98
5217501-2003	2247-3M25M	Gun Adapter, 3" Male x 2.5" MIPT	\$180.53
5217501-2502	2247-3M2F	Gun Adapter, 3" Male x 2" FIPT	\$173.70
5217501-2004	2247-3M3M	Gun Adapter, 3" Male x 3" MIPT	\$196.95
5217501-2504	2247-3M3F	Gun Adapter, 3" Male x 3" FIPT	\$214.88
5217501-4002	2247-4M3M	Gun Adapter, 4" Male x 3" MIPT	\$203.25
5217501-4004	2247-4M4M	Gun Adapter, 4" Male x 4" MIPT	\$233.93
5217601-0003	2248-3	Gun Adapter, 3" Plug	\$129.38
5217601-0004	2248-4	Gun Adapter, 4" Plug	\$136.20
3011301-0004	3070-4	Gun Adapter, 4" Ring Lock Band - for 3"	\$59.93
3011301-0005	3070-5	Gun Adapter, 5" Ring Lock Band - for 4"	\$62.25
9090110-0003	2305-3	Gun Adapter, 3" Gasket	\$6.53
9090110-0004	2305-4	Gun Adapter, 4" Gasket	\$6.60
9090110-9003	1080-3	Gun Adapter, 3" Gasket (Old Style Narrow)	\$10.28
9090110-9004	1080-4	Gun Adapter, 4" Gasket (Old Style Narrow)	\$11.93



ALUMINUM GUN STAND

This tripod style gun stand is made from aluminum, making it lighter weight and more easily transportable than steel gun stands of the same design. It is constructed with 3/4" support legs and a 3" aluminum riser. Standard height is 48". It can be ordered with either a 3" or 4" Band and Latch inlet. Other heights and connections are available upon special order.

Part No.	Description	Price
17-3	3" Inlet x 3" & 4" Mainline Clamp x 2" FIPT & 2-1/2" MIPT Top Conn.	\$670.31
17-4	4" Inlet x 3" & 4" Mainline Clamp x 2" FIPT & 2-1/2" MIPT Top Conn.	\$670.31



GALVANIZED GUN CART

This heavy-duty cart is supplied with a 3" or 4" Band and Latch inlet and a 2" FIPT x 2-1/2" MIPT or 3" FIPT outlet. A 84" long, 4" diameter, 6' axle with 46" wheels. The weight of this cart is 150 lbs. and has a corrosion resistant galvanized coating. Other options are available upon request. This price does not include a sprinkler.

Part No.	Description	Price
5046-3	Two Wheel Gun Cart 3" B & L Inlet X 2" FIPT / 2-1/2" MIPT Outlet	\$1,067.08
5046-4	Two Wheel Gun Cart 4" B & L Inlet X 2" FIPT / 2-1/2" MIPT Outlet	\$1,028.66

MALLEABLE FITTINGS

TEE

Size	Galvanized	Price	Black	Price
1/8"	ZMGT00	\$4.87	ZMBT00	\$3.78
1/4"	ZMGT01	\$4.22	ZMBT01	\$3.58
3/8"	ZMGT02	\$4.22	ZMBT02	\$3.58
1/2"	ZMGT03	\$2.60	ZMBT03	\$2.31
3/4"	ZMGT04	\$4.36	ZMBT04	\$3.27
1"	ZMGT05	\$7.14	ZMBT05	\$5.76
1-1/4"	ZMGT06	\$11.28	ZMBT06	\$9.36
1-1/2"	ZMGT07	\$14.08	ZMBT07	\$11.65
2"	ZMGT08	\$23.50	ZMBT08	\$19.80
2-1/2"	ZMGT09	\$63.10	ZMBT09	\$40.72
3"	ZMGT10	\$73.99	ZMBT10	\$61.13
4"	ZMGT11	\$174.95	ZMBT11	\$143.52
5"	ZMGT12	call	ZMBT12	\$386.82
6"	ZMGT13	\$501.47	ZMBT13	\$410.06



REDUCING TEE (REDUCE 2 SIZES)

Size	Galvanized	Price	Black	Price
3/4" x 1/2"	ZMGTR0403	\$6.02	ZMBTR0403	\$5.05
1" x 3/4"	ZMGTR0504	\$8.45	ZMBTR0504	\$6.42
1-1/4" x 1"	ZMGTR0605	\$13.07	ZMBTR0605	\$10.21
1-1/2" x 1"	ZMGTR0705	\$16.18	ZMBTR0705	\$12.91
1-1/2" x 1-1/4"	ZMGTR0706	\$20.03	ZMBTR0706	\$15.90
2" x 1"	ZMGTR0805	\$23.61	ZMBTR0805	\$20.21
2" x 1-1/4"	ZMGTR0806	\$27.46	ZMBTR0806	\$21.36
2" x 1-1/2"	ZMGTR0807	\$27.46	ZMBTR0807	\$21.36

Additional Sizes Available Upon Request



45° ELBOW

Size	Galvanized	Price	Black	Price
1/8"	ZMGL4500	\$4.88	ZMBL4500	\$3.58
1/4"	ZMGL4501	\$4.34	ZMBL4501	\$3.66
3/8"	ZMGL4502	\$4.33	ZMBL4502	\$3.33
1/2"	ZMGL4503	\$3.33	ZMBL4503	\$2.89
3/4"	ZMGL4504	\$4.66	ZMBL4504	\$3.53
1"	ZMGL4505	\$5.34	ZMBL4505	\$4.49
1-1/4"	ZMGL4506	\$9.75	ZMBL4506	\$7.86
1-1/2"	ZMGL4507	\$11.62	ZMBL4507	\$9.70
2"	ZMGL4508	\$17.34	ZMBL4508	\$14.61
2-1/2"	ZMGL4509	\$58.74	ZMBL4509	\$41.22
3"	ZMGL4510	\$85.40	ZMBL4510	\$53.51
4"	ZMGL4511	\$143.13	ZMBL4511	\$103.97
5"	ZMGL4512	Call	ZMBL4512	\$344.60
6"	ZMGL4513	\$501.44	ZMBL4513	\$354.31



Intro 1 - Pivot 2 - Valves 3 - Surface 4 - IPS Epoxy / Galv. 5 - Suction Fittings 6 - PVC Fittings 7 - Sprinklers 8 - Malleable 9 - Hose 10 - Injectors / Filters 11 - Low Volume Formulas / TC

45° STREET ELBOW

Size	Galvanized	Price	Black	Price
1/8"	ZMGLST4500	\$6.36	ZMBLST4500	\$5.56
1/4"	ZMGLST4501	\$5.45	ZMBLST4501	\$4.13
3/8"	ZMGLST4502	\$6.23	ZMBLST4502	\$4.70
1/2"	ZMGLST4503	\$4.81	ZMBLST4503	\$3.77
3/4"	ZMGLST4504	\$7.78	ZMBLST4504	\$5.80
1"	ZMGLST4505	\$9.62	ZMBLST4505	\$6.73
1-1/4"	ZMGLST4506	\$14.41	ZMBLST4506	\$11.65
1-1/2"	ZMGLST4507	\$17.45	ZMBLST4507	\$14.46
2"	ZMGLST4508	\$29.99	ZMBLST4508	\$24.38
2-1/2"	ZMGLST4509	call	ZMBLST4509	\$51.87
3"	ZMGLST4510	\$105.49	ZMBLST4510	\$79.49
4"	ZMGLST4511	\$171.52	ZMBLST4511	\$148.85



90° ELBOW

Size	Galvanized	Price	Black	Price
1/8"	ZMGL9000	\$3.23	ZMBL9000	\$2.48
1/4"	ZMGL9001	\$3.24	ZMBL9001	\$2.36
3/8"	ZMGL9002	\$3.24	ZMBL9002	\$2.36
1/2"	ZMGL9003	\$2.14	ZMBL9003	\$1.77
3/4"	ZMGL9004	\$2.57	ZMBL9004	\$2.14
1"	ZMGL9005	\$4.82	ZMBL9005	\$3.75
1-1/4"	ZMGL9006	\$7.43	ZMBL9006	\$6.09
1-1/2"	ZMGL9007	\$9.79	ZMBL9007	\$8.02
2"	ZMGL9008	\$16.32	ZMBL9008	\$13.76
2-1/2"	ZMGL9009	\$40.67	ZMBL9009	\$29.87
3"	ZMGL9010	\$68.36	ZMBL9010	\$44.54
4"	ZMGL9011	\$118.32	ZMBL9011	\$94.72
5"	ZMGL9012	\$277.98	ZMBL9012	\$209.98
6"	ZMGL9013	\$501.44	ZMBL9013	\$354.31



90° STREET ELBOW

Size	Galvanized	Price	Black	Price
1/8"	ZMGLST9000	\$4.59	ZMBLST9000	\$3.58
1/4"	ZMGLST9001	\$4.45	ZMBLST9001	\$3.58
3/8"	ZMGLST9002	\$4.45	ZMBLST9002	\$3.58
1/2"	ZMGLST9003	\$4.59	ZMBLST9003	\$3.67
3/4"	ZMGLST9004	\$4.45	ZMBLST9004	\$3.58
1"	ZMGLST9005	\$6.05	ZMBLST9005	\$5.14
1-1/4"	ZMGLST9006	\$10.18	ZMBLST9006	\$7.86
1-1/2"	ZMGLST9007	\$12.54	ZMBLST9007	\$10.48
2"	ZMGLST9008	\$21.74	ZMBLST9008	\$17.00
2-1/2"	ZMGLST9009	\$58.94	ZMBLST9009	\$41.97
3"	ZMGLST9010	\$88.97	ZMBLST9010	\$64.04
4"	ZMGLST9011	\$146.87	ZMBLST9011	\$104.30
6"	MGLST9013	Call	MBLST9013	Call



REDUCING 90° ELBOW

Size	Galvanized	Price	Black	Price
1" x 3/4"	ZMGLR0504	\$5.56	ZMBLR0504	\$4.29
1-1/4" x 1"	ZMGLR0605	\$9.33	ZMBLR0605	\$6.98
1-1/2" x 1-1/4"	ZMGLR0706	\$14.34	ZMBLR0706	\$11.44
2" x 3/4"	ZMGLR0804	\$20.32	ZMBLR0804	\$16.82
2" x 1"	ZMGLR0805	\$19.92	ZMBLR0805	\$16.49
2" x 1-1/4"	ZMGLR0806	\$19.92	ZMBLR0806	\$16.49
2" x 1-1/2"	ZMGLR0807	\$17.40	ZMBLR0807	\$14.49

Additional Sizes Available Upon Request



CROSS

Size	Galvanized	Price	Black	Price
1/8"	MGCR00	Call	MBCR00	Call
1/4"	ZMGCR01	\$10.77	ZMBCR01	\$7.24
3/8"	ZMGCR02	\$10.77	ZMBCR02	\$7.39
1/2"	ZMGCR03	\$10.79	ZMBCR03	\$8.40
3/4"	ZMGCR04	\$13.16	ZMBCR04	\$10.25
1"	ZMGCR05	\$18.16	ZMBCR05	\$12.61
1-1/4"	ZMGCR06	\$26.28	ZMBCR06	\$20.48
1-1/2"	ZMGCR07	\$31.91	ZMBCR07	\$25.37
2"	ZMGCR08	\$60.84	ZMBCR08	\$42.00
2-1/2"	ZMGCR09	Call	ZMBCR09	\$74.04
3"	ZMGCR10	Call	ZMBCR10	Call
4"	ZMGCR11	Call	ZMBCR11	Call

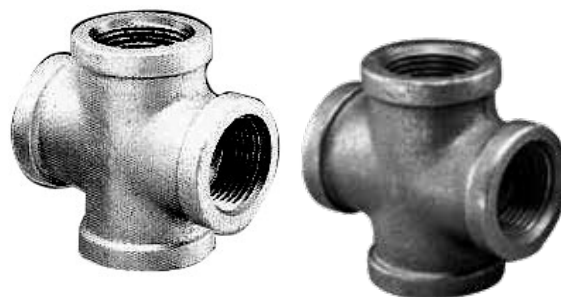

BANDED COUPLING

Size	Galvanized	Price	Black	Price
1/8"	ZMGCP00	\$4.04	ZMBCP00	\$3.48
1/4"	ZMGCP01	\$3.75	ZMBCP01	\$2.95
3/8"	ZMGCP02	\$3.75	ZMBCP02	\$2.95
1/2"	ZMGCP03	\$3.02	ZMBCP03	\$2.40
3/4"	ZMGCP04	\$3.49	ZMBCP04	\$2.83
1"	ZMGCP05	\$5.75	ZMBCP05	\$4.28
1-1/4"	ZMGCP06	\$7.91	ZMBCP06	\$5.48
1-1/2"	ZMGCP07	\$9.01	ZMBCP07	\$0.31
2"	ZMGCP08	\$13.15	ZMBCP08	\$10.67
2-1/2"	ZMGCP09	\$40.16	ZMBCP09	\$29.07
3"	ZMGCP10	\$53.66	ZMBCP10	\$39.28
4"	ZMGCP11	\$113.98	ZMBCP11	\$78.34
5"	ZMGCP12	\$262.59	ZMBCP12	\$162.55
6"	ZMGCP13	\$297.13	ZMBCP13	\$210.17

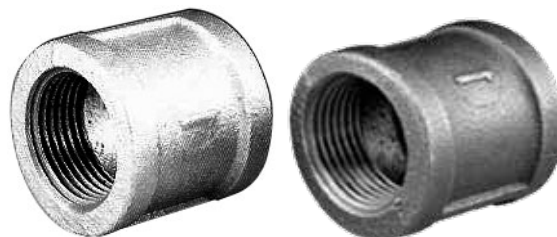

REDUCER COUPLING

Size	Galvanized	Price	Black	Price
1/4" x 1/8"	ZMGCPR0100	\$3.54	ZMBCPR0100	\$2.87
3/8" x 1/8"	ZMGCPR0200	\$3.58	ZMBCPR0200	\$2.87
3/8" x 1/4"	ZMGCPR0201	\$3.54	ZMBCPR0201	\$2.87
1/2" x 1/8"	ZMGCPR0300	\$3.98	ZMBCPR0300	\$2.85
1/2" x 1/4"	ZMGCPR0301	\$3.23	ZMBCPR0301	\$2.61
1/2" x 3/8"	ZMGCPR0302	\$3.02	ZMBCPR0302	\$2.47
3/4" x 1/8"	ZMGCPR0400	\$4.07	ZMBCPR0400	\$3.33
3/4" x 1/4"	ZMGCPR0401	\$3.99	ZMBCPR0401	\$3.24
3/4" x 3/8"	ZMGCPR0402	\$3.99	ZMBCPR0402	\$3.24
3/4" x 1/2"	ZMGCPR0403	\$3.53	ZMBCPR0403	\$2.83
1" x 1/4"	ZMGCPR0501	\$7.08	ZMBCPR0501	\$5.01
1" x 3/8"	ZMGCPR0502	\$7.23	ZMBCPR0502	\$5.09
1" x 1/2"	ZMGCPR0503	\$5.88	ZMBCPR0503	\$4.39
1" x 3/4"	ZMGCPR0504	\$5.45	ZMBCPR0504	\$4.39
1-1/4" x 3/8"	MGCPR0602	Call	MBCPR0602	Call
1-1/4" x 1/2"	ZMGCPR0603	\$9.26	ZMBCPR0603	\$6.32
1-1/4" x 3/4"	ZMGCPR0604	\$7.48	ZMBCPR0604	\$5.48
1-1/4" x 1"	ZMGCPR0605	\$7.48	ZMBCPR0605	\$5.48
1-1/2" x 3/8"	MGCPR0702	Call	MBCPR0702	Call
1-1/2" x 1/2"	ZMGCPR0703	\$10.89	ZMBCPR0703	\$8.03
1-1/2" x 3/4"	ZMGCPR0704	\$9.64	ZMBCPR0704	\$9.05
1-1/2" x 1"	ZMGCPR0705	\$9.64	ZMBCPR0705	\$8.03
1-1/2" x 1-1/4"	ZMGCPR0706	\$9.11	ZMBCPR0706	\$6.93
2" x 3/8"	MGCPR0802	Call	MBCPR0802	Call
2" x 1/2"	ZMGCPR0803	\$15.72	ZMBCPR0803	\$13.08
2" x 3/4"	ZMGCPR0804	\$15.72	ZMBCPR0804	\$11.51
2" x 1"	ZMGCPR0805	\$13.15	ZMBCPR0805	\$10.89
2" x 1-1/4"	ZMGCPR0806	\$13.89	ZMBCPR0806	\$11.51
2" x 1-1/2"	ZMGCPR0807	\$13.15	ZMBCPR0807	\$10.07
2-1/2" x 1/2"	MGCPR0903	Call	ZMBCPR0903	\$29.27
2-1/2" x 3/4"	MGCPR0904	Call	ZMBCPR0904	\$29.27
2-1/2" x 1"	MGCPR0905	Call	ZMBCPR0905	\$29.27
2-1/2" x 1-1/4"	ZMGCPR0906	\$40.60	ZMBCPR0906	\$29.27
2-1/2" x 1-1/2"	ZMGCPR0907	\$41.44	ZMBCPR0907	\$29.94
2-1/2" x 2"	ZMGCPR0908	\$40.66	ZMBCPR0908	\$25.68
3" x 3/4"	MGCPR1004	Call	MBCPR1004	Call
3" x 1"	ZMGCPR1005	\$55.05	ZMBCPR1005	\$40.80
3" x 1-1/4"	ZMGCPR1006	\$55.05	ZMBCPR1006	\$40.80
3" x 1-1/2"	ZMGCPR1007	\$54.01	ZMBCPR1007	\$40.04
3" x 2"	ZMGCPR1008	\$51.05	ZMBCPR1008	\$33.20
3" x 2-1/2"	ZMGCPR1009	\$54.01	ZMBCPR1009	\$40.04
4" x 1"	MGCPR1105	Call	MBCPR1105	Call
4" x 1-1/4"	MGCPR1106	Call	MBCPR1106	Call
4" x 1-1/2"	ZMGCPR1107	\$128.51	ZMBCPR1107	\$80.27
4" x 2"	ZMGCPR1108	\$116.89	ZMBCPR1108	\$80.27
4" x 2-1/2"	ZMGCPR1109	\$116.89	ZMBCPR1109	\$80.27
4" x 3"	ZMGCPR1110	\$116.89	ZMBCPR1110	\$80.27
6" x 3"	MGCPR1310	Call	ZMBCPR1310	Call
6" x 4"	MGCPR1311	Call	ZMBCPR1311	Call



HEX BUSHING

Size	Galvanized	Price	Black	Price
1/4" x 1/8"	ZMGBU0100	\$4.55	ZMBBU0100	\$3.16
3/8" x 1/8"	ZMGBU0200	Call	ZMBBU0200	\$3.16
3/8" x 1/4"	ZMGBU0201	\$4.55	ZMBBU0201	\$3.16
1/2" x 1/8"	ZMGBU0300	\$4.55	ZMBBU0300	\$3.16
1/2" x 1/4"	ZMGBU0301	\$0.55	ZMBBU0301	\$3.16
1/2" x 3/8"	ZMGBU0302	\$4.55	ZMBBU0302	\$3.16
3/4" x 1/8"	ZMGBU0400	\$5.22	ZMBBU0400	\$3.10
3/4" x 1/4"	ZMGBU0401	\$4.70	ZMBBU0401	\$3.10
3/4" x 3/8"	ZMGBU0402	\$5.22	ZMBBU0402	\$3.10
3/4" x 1/2"	ZMGBU0403	\$4.22	ZMBBU0403	\$2.87
1" x 1/8"	ZMGBU0500	\$4.96	ZMBBU0500	\$3.58
1" x 1/4"	ZMGBU0501	\$5.56	ZMBBU0501	\$3.84
1" x 3/8"	ZMGBU0502	\$8.72	ZMBBU0502	\$3.95
1" x 1/2"	ZMGBU0503	\$5.05	ZMBBU0503	\$2.95
1" x 3/4"	ZMGBU0504	\$4.77	ZMBBU0504	\$2.95
1-1/4" x 1/8"	MGBU0600	Call	MBBU0600	Call
1-1/4" x 1/4"	ZMGBU0601	\$8.03	ZMBBU0601	\$4.99
1-1/4" x 3/8"	ZMGBU0602	\$8.03	ZMBBU0602	\$4.43
1-1/4" x 1/2"	ZMGBU0603	\$7.06	ZMBBU0603	\$4.23
1-1/4" x 3/4"	ZMGBU0604	\$6.43	ZMBBU0604	\$3.80
1-1/4" x 1"	ZMGBU0605	\$6.43	ZMBBU0605	\$3.80
1-1/2" x 1/8"	ZMGBU0700	Call	ZMBBU0700	\$5.84
1-1/2" x 1/4"	ZMGBU0701	\$10.21	ZMBBU0701	\$5.84
1-1/2" x 3/8"	ZMGBU0702	\$10.21	ZMBBU0702	\$5.84
1-1/2" x 1/2"	ZMGBU0703	\$9.33	ZMBBU0703	\$4.82
1-1/2" x 3/4"	ZMGBU0704	\$9.33	ZMBBU0704	\$4.82
1-1/2" x 1"	ZMGBU0705	\$8.41	ZMBBU0705	\$4.23
1-1/2" x 1-1/4"	ZMGBU0706	\$7.76	ZMBBU0706	\$4.83
2" x 1/4"	ZMGBU0801	\$6.81	MBBU0801	\$7.32
2" x 3/8"	ZMGBU0802	\$11.89	ZMBBU0802	\$7.28
2" x 1/2"	ZMGBU0803	\$11.65	ZMBBU0803	\$7.28
2" x 3/4"	ZMGBU0804	\$10.85	ZMBBU0804	\$6.15
2" x 1"	ZMGBU0805	\$10.26	ZMBBU0805	\$5.77
2" x 1-1/4"	ZMGBU0806	\$10.26	ZMBBU0806	\$5.77
2" x 1-1/2"	ZMGBU0807	\$8.99	ZMBBU0807	\$6.43
2-1/2" x 1/2"	ZMGBU0903	\$16.87	ZMBBU0903	\$10.49
2-1/2" x 3/4"	ZMGBU0904	\$16.86	ZMBBU0904	\$10.49
2-1/2" x 1"	ZMGBU0905	\$16.86	ZMBBU0905	\$10.49
2-1/2" x 1-1/4"	ZMGBU0906	\$16.86	ZMBBU0906	\$10.49
2-1/2" x 1-1/2"	ZMGBU0907	\$16.55	ZMBBU0907	\$9.77
2-1/2" x 2"	ZMGBU0908	\$14.67	ZMBBU0908	\$9.68
3" x 3/4"	MGBU1004	Call	MBBU1004	Call
3" x 1"	ZMGBU1005	\$22.27	ZMBBU1005	\$14.50
3" x 1-1/4"	ZMGBU1006	\$22.27	ZMBBU1006	\$14.50
3" x 1-1/2"	ZMGBU1007	\$21.83	ZMBBU1007	\$14.22
3" x 2"	ZMGBU1008	\$19.80	ZMBBU1008	\$13.28
3" x 2-1/2"	ZMGBU1009	\$20.94	ZMBBU1009	\$13.49



Size	Galvanized	Price	Black	Price
4" x 1"	ZMGBU1105	\$46.68	ZMBBU1105	\$27.83
4" x 1-1/4"	ZMGBU1106	\$46.68	ZMBBU1106	Call
4" x 1-1/2"	ZMGBU1107	\$46.68	ZMBBU1107	\$27.83
4" x 2"	ZMGBU1108	\$41.17	ZMBBU1108	\$26.33
4" x 2-1/2"	ZMGBU1109	\$46.68	ZMBBU1109	\$26.33
4" x 3"	ZMGBU1110	\$43.59	ZMBBU1110	\$26.33
5" x 3"	ZMGBU1210	Call	ZMBBU1210	\$48.09
5" x 4"	ZMGBU1211	Call	ZMBBU1211	\$48.09
6" x 2"	ZMGBU1308	Call	ZMBBU1308	\$69.56
6" x 3"	ZMGBU1310	Call	ZMBBU1310	\$69.56
6" x 4"	ZMGBU1311	\$89.69	ZMBBU1311	\$69.56
6" x 5"	ZMGBU1312	Call	ZMBBU1312	\$100.13

MALLEABLE FITTINGS

UNION

Size	Galvanized	Price	Black	Price
1/8"	ZMGUN00	\$15.08	ZMBUN00	\$12.77
1/4"	ZMGUN01	\$14.56	ZMBUN01	\$12.16
3/8"	ZMGUN02	\$9.68	ZMBUN02	\$8.20
1/2"	ZMGUN03	\$9.79	ZMBUN03	\$7.83
3/4"	ZMGUN04	\$11.62	ZMBUN04	\$9.33
1"	ZMGUN05	\$14.45	ZMBUN05	\$12.20
1-1/4"	ZMGUN06	\$19.64	ZMBUN06	\$16.18
1-1/2"	ZMGUN07	\$25.15	ZMBUN07	\$19.76
2"	ZMGUN08	\$33.60	ZMBUN08	\$29.85
2-1/2"	ZMGUN09	\$93.48	ZMBUN09	\$71.94
3"	ZMGUN10	\$132.82	ZMBUN10	\$87.34
4"	ZMGUN11	\$288.49	ZMBUN11	\$215.96



SQUARE HEAD PLUG

Size	Galvanized	Price	Black	Price
1/8"	ZMGPL00	\$2.48	ZMBPL00	\$1.52
1/4"	ZMGPL01	\$2.48	ZMBPL01	\$1.52
3/8"	ZMGPL02	\$2.48	ZMBPL02	\$1.52
1/2"	ZMGPL03	\$3.11	ZMBPL03	\$1.61
3/4"	ZMGPL04	\$3.11	ZMBPL04	\$1.61
1"	ZMGPL05	\$3.40	ZMBPL05	\$2.03
1-1/4"	ZMGPL06	\$5.24	ZMBPL06	\$2.56
1-1/2"	ZMGPL07	\$7.08	ZMBPL07	\$3.56
2"	ZMGPL08	\$8.99	ZMBPL08	\$5.08
2-1/2"	ZMGPL09	\$17.53	ZMBPL09	\$9.26
3"	ZMGPL10	\$24.87	ZMBPL10	\$12.71
4"	ZMGPL11	\$51.61	ZMBPL11	\$26.67
5"	ZMGPL12	Call	ZMBPL12	\$57.21
6"	ZMGPL13	\$102.37	ZMBPL13	\$70.86

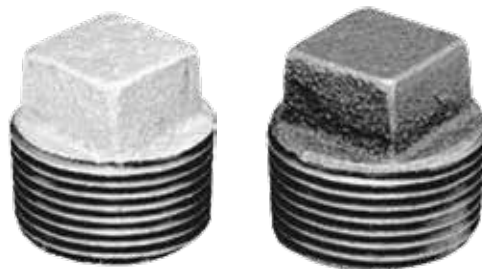

CAP

Size	Galvanized	Price	Black	Price
1/8"	ZMGCA00	\$3.00	ZMBCA00	\$2.32
1/4"	ZMGCA01	\$3.00	ZMBCA01	\$2.32
3/8"	ZMGCA02	\$2.91	ZMBCA02	\$2.32
1/2"	ZMGCA03	\$2.23	ZMBCA03	\$1.77
3/4"	ZMGCA04	\$3.23	ZMBCA04	\$2.40
1"	ZMGCA05	\$3.54	ZMBCA05	\$2.89
1-1/4"	ZMGCA06	\$5.14	ZMBCA06	\$3.78
1-1/2"	ZMGCA07	\$6.57	ZMBCA07	\$5.14
2"	ZMGCA08	\$8.30	ZMBCA08	\$6.73
2-1/2"	ZMGCA09	\$26.42	ZMBCA09	\$16.71
3"	ZMGCA10	\$32.01	ZMBCA10	\$24.84
4"	ZMGCA11	\$63.57	ZMBCA11	\$38.76
5"	ZMGCA12	Call	ZMBCA12	\$81.51
6"	ZMGCA13	\$231.35	ZMBCA13	\$154.84

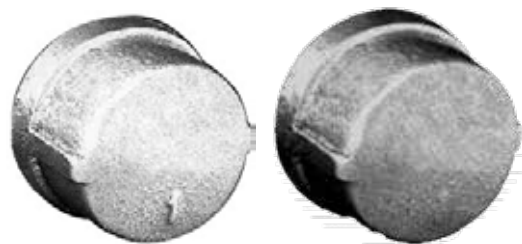

MERCHANT FITTINGS

STANDARD MERCHANT COUPLERS

Size	Galv. Full Part No.	Price	Black Full Part No.	Price	Black Half Part No.	Price
1/8"	M-CG00	\$1.37	M-CB00	\$1.12	M-HCB00	\$1.08
1/4"	M-CG01	\$1.77	M-CB01	\$1.53	M-HCB01	\$1.46
3/8"	M-CG02	\$2.28	M-CB02	\$1.86	M-HCB02	\$1.76
1/2"	M-CG03	\$2.42	M-CB03	\$1.99	M-HCB03	\$1.76
3/4"	M-CG04	\$3.03	M-CB04	\$2.52	M-HCB04	\$2.02
1"	M-CG05	\$4.25	M-CB05	\$3.53	M-HCB05	\$2.82
1-1/4"	M-CG06	\$5.43	M-CB06	\$4.51	M-HCB06	\$3.59
1-1/2"	M-CG07	\$6.73	M-CB07	\$5.69	M-HCB07	\$4.55
2"	M-CG08	\$10.06	M-CB08	\$8.16	M-HCB08	\$6.53
2-1/2"	M-CG09T	\$28.53	M-CB09T	\$23.22	M-HCB09T	\$15.56
3"	M-CG10T	\$37.86	M-CB10T	\$32.61	M-HCB10T	\$21.85
4"	M-CG11T	\$66.75	M-CB11T	\$57.79	M-HCB11T	\$38.74
5"	M-CG12T	\$124.13	M-CB12T	\$105.84	M-HCB12T	\$70.91
6"	M-CG13T	\$152.76	M-CB13T	\$126.71	M-HCB13T	\$84.88

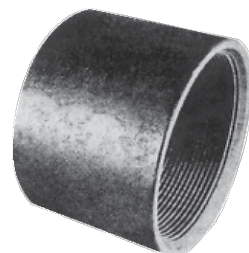

A.P.I. LINE & EXTRA HEAVY RECESSED COUPLINGS

Size	Galvanized Part No.	Price	Black Part No.	Price
8"	M-APIG14	\$279.02	M-APIB14	\$249.08
10"	-	-	M-APIB15	\$392.68
12"	-	-	M-APIB16	\$525.44

MERCHANT SQUARE HEAD PLUG

Size	Galvanized Part No.	Price	Black Part No.	Price
1/8"	M-PG00	\$0.37	M-PB00	\$0.31
1/4"	M-PG01	\$0.49	M-PB01	\$0.42
3/8"	M-PG02	\$0.64	M-PB02	\$0.58
1/2"	M-PG03	\$1.00	M-PB03	\$0.82
3/4"	M-PG04	\$1.09	M-PB04	\$1.36



MERCHANT HEX HEAD PLUG

Size	Galvanized Part No.	Price	Black Part No.	Price
1/8"	M-PHHG00	\$0.71	M-PHHB00	\$0.50
1/4"	M-PHHG01	\$0.78	M-PHHB01	\$0.73
3/8"	M-PHHG02	\$1.01	M-PHHB02	\$0.98.00
1/2"	M-PHHG03	\$1.58	M-PHHB03	\$1.46
3/4"	M-PHHG04	\$2.56	M-PHHB04	\$2.37



STEEL PIPE NIPPLES

BLACK STANDARD WELDED TOE STEEL PIPE NIPPLE

Part No.	Size	Length	Price
ZNB083TOE	2"	3"	Call
ZNB093TOE	2-1/2"	3"	Call
ZNB103TOE	3"	3"	Call
ZNB114TOE	4"	4"	Call
ZNB134TOE	6"	4"	Call
ZNB146TOE	8"	6"	Call



BLACK STANDARD WELDED GOE STEEL PIPE NIPPLE

Part No.	Size	Price
F011-XC120	2"	\$21.90
F011-XC130	3"	\$25.80
F011-XC140	4"	\$33.60
F011-XC150	5"	\$52.80
F011-XC160	6"	\$56.40
F011-XC180	8"	\$96.00
F011-XC190	10"	\$103.20



Intro 1 - Pivot 2 - Valves 3 - Surface 4 - IPS Epoxy / Galv 5 - Suction Fittings 6 - PVC Fittings 7 - Sprinklers 8 - Malleable 9 - Hose 10 - Injectors / Filters 11 - Low Volume Formulas / TC

STEEL PIPE NIPPLES

GALVANIZED STANDARD WELDED STEEL PIPE NIPPLES - THREADED BOTH ENDS

Length →		Close Part No. Price	2" Part No. Price	4" Part No. Price	6" Part No. Price	8" Part No. Price	10" Part No. Price	12" Part No. Price
Pipe Size	↓ Close Length							
1/8"	3/4"	ZNG00CL	ZNG002	ZNG004	ZNG006	ZNG008	ZNG0010	ZNG0012
		\$1.46	\$2.02	\$3.16	\$5.97	\$7.88	\$9.26	\$10.25
1/4"	7/8"	ZNG01CL	ZNG012	ZNG014	ZNG016	ZNG018	ZNG0110	ZNG0112
		\$1.56	\$1.82	\$2.88	\$4.37	\$7.47	\$8.70	\$9.69
3/8"	1"	ZNG02CL	ZNG022	ZNG024	ZNG026	ZNG028	ZNG0210	ZNG0212
		\$1.70	\$1.95	\$3.10	\$4.75	\$7.58	\$9.04	\$10.03
1/2"	1-1/8"	ZNG03CL	ZNG032	ZNG034	ZNG036	ZNG038	ZNG0310	ZNG0312
		\$1.38	\$1.46	\$2.11	\$2.88	\$5.06	\$6.02	\$6.85
3/4"	1-3/8"	ZNG04CL	ZNG042	ZNG044	ZNG046	ZNG048	ZNG0410	ZNG0412
		\$1.68	\$1.82	\$2.61	\$3.73	\$6.48	\$7.19	\$8.05
1"	1-1/2"	ZNG05CL	ZNG052	ZNG054	ZNG056	ZNG058	ZNG0510	ZNG0512
		\$2.30	\$2.72	\$3.52	\$4.91	\$8.20	\$9.38	\$10.92
1-1/4"	1-5/8"	ZNG06CL	ZNG062	ZNG064	ZNG066	ZNG068	ZNG0610	ZNG0612
		\$3.08	\$3.35	\$4.32	\$6.22	\$10.06	\$12.04	\$14.45
1-1/2"	1-3/4"	ZNG07CL	ZNG072	ZNG074	ZNG076	ZNG078	ZNG0710	ZNG0712
		\$3.62	\$3.89	\$5.47	\$7.44	\$11.55	\$13.46	\$15.39
2"	2"	ZNG08CL		ZNG084	ZNG086	ZNG088	ZNG0810	ZNG0812
		\$5.09		\$6.96	\$10.33	\$16.85	\$19.70	\$22.60
2-1/2"	2-1/2"	ZNG09CL		ZNG094	ZNG096	ZNG098	ZNG0910	ZNG0912
		\$15.17		\$18.29	\$22.40	\$28.84	\$32.88	\$36.78
3"	2-5/8"	ZNG10CL		ZNG104	ZNG106	ZNG108	ZNG1010	ZNG1012
		\$18.19		\$24.28	\$29.93	\$40.31	\$45.98	\$51.70
4"	2-7/8"	ZNG11CL		ZNG114	ZNG116	ZNG118	ZNG1110	ZNG1112
		\$27.26		\$32.58	\$40.40	\$48.21	\$55.86	\$63.60
5"	3"	ZNG12CL		ZNG124	ZNG126	ZNG128	ZNG1210	ZNG1212
		\$130.66		\$139.95	\$167.90	\$200.05		\$267.40
6"	3-1/8"	ZNG13CL		ZNG134	ZNG136	ZNG138	ZNG1310	ZNG1312
		\$146.77		\$154.47	\$191.62	\$230.96	\$267.65	\$314.78



GALVANIZED PRE-CUT STEEL PIPE - THREADED BOTH ENDS

Length →		18" Part No. Price	24" Part No. Price	30" Part No. Price	36" Part No. Price	48" Part No. Price	60" Part No. Price	72" Part No. Price	120" Part No. Price
Pipe Size	↓								
1/4"		NG0118	NG0124	NG0130	NG0136	NG0148	NG0160	NG0172	NG01120
		\$11.18	\$14.12	-	\$18.27	\$24.05	\$29.86	\$33.54	-
3/8"		NG0218	NG0224	NG0230	NG0236	NG0248	NG0260	NG0272	NG02120
		\$12.42	\$15.23	\$17.99	\$19.87	\$26.14	\$31.43	\$36.70	-
1/2"		NG0318	NG0324	NG0330	NG0336	NG0348	NG0360	NG0372	NG03120
		\$8.82	\$11.37	\$13.44	\$15.51	\$19.92	\$24.55	\$28.98	-
3/4"		NG0418	NG0424	NG0430	NG0436	NG0448	NG0460	NG0472	NG04120
		\$10.50	\$13.48	\$16.56	\$19.04	\$24.87	\$30.44	\$35.96	-
1"		NG0518	NG0524	NG0530	NG0536	NG0548	NG0560	NG0572	NG05120
		\$13.56	\$17.99	\$21.03	\$24.05	\$31.87	\$40.10	\$47.90	-
1-1/4"		NG0618	NG0624	NG0630	NG0636	NG0648	NG0660	NG0672	NG06120
		\$17.86	\$23.92	\$28.26	\$32.59	\$43.20	\$53.73	\$66.06	-
1-1/2"		NG0718	NG0724	NG0730	NG0736	NG0748	NG0760	NG0772	NG07120
		\$20.27	\$27.14	\$32.76	\$38.38	\$47.81	\$51.01	\$64.67	-
2"		NG0818	NG0824	NG0830	NG0836	NG0848	NG0860	NG0872	NG08120
		\$27.64	\$36.57	\$43.05	\$49.51	\$64.35	\$80.41	\$97.96	-
2-1/2"		NG0918	NG0924	NG0930	NG0936	NG0948	NG0960	NG0972	NG09120
		\$52.75	\$59.04	\$79.13	\$88.56	\$118.09	-	\$184.44	-
3"		NG1018	NG1024	NG1030	NG1036	NG1048	NG1060	NG1072	NG10120
		\$73.78	\$82.97	\$110.67	\$128.78	\$165.92	\$207.40	\$248.88	-
4"		NG1118	NG1124	NG1130	NG1136	NG1148	NG1160	NG1172	NG11120
		\$89.63	\$102.04	\$134.44	\$153.04	\$204.08	\$255.11	\$306.14	-



STEEL PIPE NIPPLES

BLACK STANDARD WELDED STEEL PIPE NIPPLES - THREADED BOTH ENDS

Pipe Size	Length →		Close Part No. Price	2" Part No. Price	4" Part No. Price	6" Part No. Price	8" Part No. Price	10" Part No. Price	12" Part No. Price
	↓	Close Length							
1/8"		3/4"	ZNB00CL	ZNB002	ZNB004	ZNB006	ZNB008	ZNB0010	ZNB0012
			\$1.15	\$1.42	\$2.00	\$4.17	\$5.74	\$6.56	\$6.71
1/4"		7/8"	ZNB01CL	ZNB012	ZNB014	ZNB016	ZNB018	ZNB0110	ZNB0112
			\$1.39	\$1.48	\$2.21	\$3.95	\$6.07	\$7.14	\$7.88
3/8"		1"	ZNB02CL	ZNB022	ZNB024	ZNB026	ZNB028	ZNB0210	ZNB0212
			\$1.42	\$1.62	\$2.44	\$3.92	\$6.90	\$7.74	\$8.79
1/2"		1-1/8"	ZNB03CL	ZNB032	ZNB034	ZNB036	ZNB038	ZNB0310	ZNB0312
			\$1.21	\$1.21	\$1.71	\$2.24	\$4.03	\$4.84	\$5.75
3/4"		1-3/8"	ZNB04CL	ZNB042	ZNB044	ZNB046	ZNB048	ZNB0410	ZNB0412
			\$1.38	\$1.48	\$2.08	\$2.95	\$4.94	\$5.74	\$6.38
1"		1-1/2"	ZNB05CL	ZNB052	ZNB054	ZNB056	ZNB058	ZNB0510	ZNB0512
			\$2.00	\$2.20	\$2.88	\$4.04	\$6.59	\$7.71	\$8.85
1-1/4"		1-5/8"	ZNB06CL	ZNB062	ZNB064	ZNB066	ZNB068	ZNB0610	ZNB0612
			\$2.54	\$2.88	\$3.62	\$5.13	\$8.28	\$9.93	\$11.26
1-1/2"		1-3/4"	ZNB07CL	ZNB072	ZNB074	ZNB076	ZNB078	ZNB0710	ZNB0712
			\$3.16	\$3.40	\$4.28	\$5.98	\$9.50	\$11.11	\$12.81
2"		2"	ZNB08CL		ZNB084	ZNB086	ZNB088	ZNB0810	ZNB0812
			\$4.30		\$5.97	\$8.05	\$13.50	\$15.88	\$18.28
2-1/2"		2-1/2"	ZNB09CL		ZNB094	ZNB096	ZNB098	ZNB0910	ZNB0912
			\$13.46		\$16.25	\$18.61	\$23.67	\$26.59	\$29.58
3"		2-5/8"	ZNB10CL		ZNB104	ZNB106	ZNB108	ZNB1010	ZNB1012
			\$15.98		\$20.59	\$24.67	\$33.29	\$37.39	\$41.49
4"		2-7/8"	ZNB11CL		ZNB114	ZNB116	ZNB118	ZNB1110	ZNB1112
			\$24.08		\$27.86	\$34.02	\$39.27	\$44.73	\$52.42
5"		3"	ZNB12CL		ZNB124	ZNB126	ZNB128	ZNB1210	ZNB1212
			\$65.29		\$69.99	\$83.99	\$100.08	\$114.69	\$133.74
6"		3-1/8"	ZNB13CL		ZNB134	ZNB136	ZNB138	ZNB1310	ZNB1312
			\$73.40		\$77.14	\$95.81	\$115.47	\$133.74	\$157.44



BLACK PRE-CUT STEEL PIPE - THREADED BOTH ENDS

Pipe Size	Length →		18" Part No. Price	24" Part No. Price	30" Part No. Price	36" Part No. Price	48" Part No. Price	60" Part No. Price	72" Part No. Price	120" Part No. Price
	↓									
1/4"			NB0118	NB0124	NB0130	NB0136	NB0148	NB0160	NB0172	NB01120
			-	\$11.32	-	\$14.80	\$19.36	-	-	-
3/8"			NB0218	NB0224	NB0230	NB0236	NB0248	NB0260	NB0272	NB02120
			\$9.97	\$12.43	\$13.91	\$16.46	\$20.79	-	-	-
1/2"			NB0318	NB0324	NB0330	NB0336	NB0348	NB0360	NB0372	NB03120
			\$7.19	\$9.38	\$11.01	\$12.99	\$16.41	\$19.68	\$24.20	-
3/4"			NB0418	NB0424	NB0430	NB0436	NB0448	NB0460	NB0472	NB04120
			\$8.88	\$11.37	\$13.30	\$15.75	\$20.97	\$25.68	\$29.54	-
1"			NB0518	NB0524	NB0530	NB0536	NB0548	NB0560	NB0572	NB05120
			\$11.42	\$14.95	\$17.22	\$20.78	\$27.15	\$34.19	\$40.37	-
1-1/4"			NB0618	NB0624	NB0630	NB0636	NB0648	NB0660	NB0672	NB06120
			\$14.54	\$19.59	\$23.14	\$27.27	\$36.12	\$44.94	\$53.65	-
1-1/2"			NB0718	NB0724	NB0730	NB0736	NB0748	NB0760	NB0772	NB07120
			\$16.61	\$22.39	\$26.67	\$31.87	\$39.55	\$53.76	\$63.34	-
2"			NB0818	NB0824	NB0830	NB0836	NB0848	NB0860	NB0872	NB08120
			\$23.14	\$30.65	\$35.22	\$41.49	\$54.22	\$69.74	\$81.74	-
2-1/2"			NB0918	NB0924	NB0930	NB0936	NB0948	NB0960	NB0972	NB09120
			\$42.75	\$47.50	-	\$71.26	-	-	\$142.51	-
3"			NB1018	NB1024	NB1030	NB1036	NB1048	NB1060	NB1072	NB10120
			\$60.02	\$66.59	\$90.02	\$99.89	\$133.19	-	-	-
4"			NB1118	NB1124	NB1130	NB1136	NB1148	NB1160	NB1172	NB11120
			\$71.75	\$81.08	\$107.65	\$121.63	\$162.17	-	-	-

Intro 1 - Pivot 2 - Valves 3 - Surface 4 - IPS Epoxy / Galv. 5 - Suction Fittings 6 - PVC Fittings 7 - Sprinklers 8 - Malleable 9 - Hose 10 - Injectors / Filters 11 - Low Volume Formulas / TC

KURIYAMA VINYL FLOW LITE™ GENERAL PURPOSE LAYFLAT HOSE

This is a tough, economical, general purpose PVC water discharge hose featuring polyester yarn reinforcement & homogeneous PVC tube & cover. The homogeneous virgin PVC construction eliminates separation of tube & cover the high tensile polyester yarn reinforcement provides strength & durability. Nu-Flo™ is ideally suited for construction, agriculture, mining & open end water discharge applications requiring low to medium working pressure. All sizes are available in 300' coils, or by the foot at a increased price to cover handling.

Part No.	Size	Nominal I.D.	Nominal O.D.	Working PSI	Price / Coil
VFL-075X300	3/4"	.827"	.929"	70	\$156.00
VFL-100X300	1"	1.063"	1.165"	70	\$171.00
VFL-125X300	1-1/4"	1.378"	1.48"	70	\$171.00
VFL-150X300	1-1/2"	1.614"	1.716"	70	\$162.00
VFL-200X300	2"	2.106"	2.212"	65	\$189.00
VFL-250X300	2-1/2"	2.598"	2.712"	60	NA
VFL-300X300	3"	3.090"	3.208"	60	\$339.00
VFL-400X300	4"	4.094"	4.216"	60	\$456.00
VFL-500X300	5"	5.079"	5.217"	40	NA
VFL-600X300	6"	6.142"	6.284"	45	\$948.00
VFL-800X300	8"	8.150"	8.330"	45	\$1,800.00

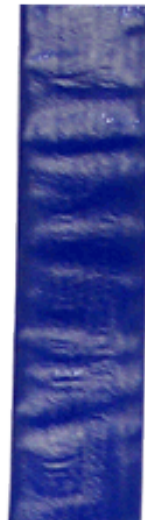

KURIYAMA VINYLFLOW® PREMIUM DRIP IRRIGATION LAYFLAT HOSE

This is a premium water discharge hose featuring a balanced polyester yarn spiral wrap, longitudinal strength member, & homogeneous PVC tube & cover. It is used for general purpose discharge applications, & is ideal for use as a drip irrigation supply line as it can be punched easily without tearing for fitting insertion. Vinylflow® lays straight with minimal elongation under pressure. Its homogeneous tube & cover construction eliminates separation. Ultraviolet inhibitors reduce aging & weather cracking. Sizes through 8" available in 300' coils and sizes 10" through 16" available in 100' coils. Layflat may be purchased by the foot at a increased price to cover handling.

Part No.	Size	Nominal I.D.	Nominal O.D.	Working PSI	Price / Coil
VF150X300	1-1/2"	1.673"	1.807"	80	\$156.00
VF200X300	2"	2.165"	2.299"	80	\$201.00
VF250X300	2-1/2"	2.598"	2.755"	80	\$297.00
VF300X300	3"	3.130"	3.287"	70	\$372.00
VF400X300	4"	4.134"	4.299"	70	\$486.00
VF500X300	5"	5.039"	5.212"	40	\$849.00
VF600X300	6"	6.181"	6.354"	50	\$858.00
VF800X300	8"	8.169"	8.382"	45	\$1,503.00
VF1000X100	10"	10.118"	10.354"	35	\$2,182.00
VF1200X100	12"	12.126"	12.362"	30	\$2,986.00
VF1400X100	14"	14.134"	14.370"	30	\$4,665.00
VF1600X100	16"	16.142"	16.378"	30	\$5,635.00



KURIYAMA IRONSIDES® HEAVY-DUTY LAYFLAT HOSE

This hose has a premium quality PVC tube & cover, reinforced with two spiral plies & longitudinal synthetic cords. It is used for irrigation, agriculture, quarry, mining, construction & industrial applications. It has a high working pressure, resists kinking & twisting, making it excellent to use with a portable hydrant or as a relay supply line hose. It has a high U.V./ozone resistance. All sizes are available in 300' coils, or by the foot at a increased price to cover handling.

Part No.	Size	Nominal I.D.	Nominal O.D.	Working PSI	Price / Ft.	Price / Coil
IS150X300	1-1/2"	1.61"	1.783"	150	\$1.45	\$435.00
IS200X300	2"	2.09"	2.271"	150	\$1.84	\$552.00
IS250X300	2-1/2"	2.58"	2.769"	150	\$2.62	\$786.00
IS300X300	3"	3.09"	3.2868"	150	\$2.84	\$852.00
IS400X300	4"	4.10"	4.320"	125	\$4.46	\$1,338.00
IS600X300	6"	6.16"	6.396"	115	\$7.39	\$2,217.00
IS800X300	8"	8.15"	8.394"	70	\$16.71	\$5,013.00



NOTE: WORKING PRESSURE BASED ON OPERATION AT 70°F.
SERVICE TEMPERATURE RANGE FOR NU-FLO™, VINYLFLOW®, & IRONSIDES® IS 5°F TO 170°F.

KURIYAMA TIGERFLEX BW "BLUE WATER" SUCTION & DISCHARGE HOSE

This is a multi-purpose low temperature suction & transfer hose for use in irrigation, agriculture, construction, mining & for abrasive liquid applications. It has a clear body with a blue helix & is constructed from HMW clear PVC resin to allow for visual confirmation that material is flowing. The HMW PVC body provides sub-zero flexibility & increased abrasion resistance compared to standard PVC. It is made with a smooth cover on sizes 3/4" - 4" making clamping easy, & a convoluted cover on 5" & 6" for greater flexibility. The service temperature range is -40°F to 150°F. All sizes are available in 100' coils. In addition, 5" & 6" is available in 20' lengths. Available for purchase by the foot or by the coil.

Part No.	Nominal I.D.	Nominal O.D.	Working PSI	Price / Ft.	Price / Coil
BW075X100	3/4"	1.01"	115	\$1.86	\$186.00
BW100X100	1"	1.26"	90	\$2.25	\$225.00
BW125X100	1-1/4"	1.56"	90	\$2.55	\$255.00
BW150X100	1-1/2"	1.79"	90	\$2.94	\$294.00
BW200X100	2"	2.35"	90	\$4.24	\$424.00
BW250X100	2-1/2"	2.87"	75	\$6.66	\$666.00
BW300X100	3"	3.43"	65	\$8.00	\$800.00
BW400X100	4"	4.49"	55	\$14.10	\$1,410.00
BW500X100	5"	5.57"	45	\$25.01	\$2,501.00
BW600X100	6"	6.69"	40	\$27.81	\$2,781.00



KURIYAMA TIGERFLEX TG "TIGER GREEN" EPDM SUCTION & DISCHARGE HOSE

This is a suction hose for outdoor wet or dry applications. It is constructed from black flexible EPDM rubber with a bright green polyethylene helix, providing for an excellent blend of chemical resistance & physical durability. Its features include excellent cold weather flexibility, a U.V. weather resistant exterior, a specially designed abrasion resistant helix, a smooth bore interior to eliminate material buildup, a convoluted cover design to provide increased flexibility, & it's lightweight. General applications include irrigation, agricultural, liquid & dry fertilizer & chemical, liquid waste, slurries, septic handling, water transfer, mining & construction. The service temperature range is -40°F to 160°F. All sizes available in 100' coils, or by the foot at an increased price to cover handling.

Part No.	Nominal I.D.	Nominal O.D.	Working PSI	Price / Ft.	Price / Coil
TG200X100	2"	2.51"	50	\$5.16	\$516.00
TG300X100	3"	3.60"	45	\$9.79	\$979.00
TG400X100	4"	4.70"	40	\$16.39	\$1,639.00
TG600X100	6"	6.85"	30	\$31.34	\$3,134.00



KURIYAMA ALFAGOMMA® WATER SUCTION & DISCHARGE HOSE

This is a multi-purpose water suction & discharge hose for delivery of non-corrosive liquids for irrigation & construction. Model T202AA, sizes 2", 3" & 4", is manufactured from black EPDM rubber, & as such will accept fertilizers & lasso acid solutions. Models T203AA & T204AA, sizes 6", 8", 10" & 12", are manufactured with black SBR rubber. Each features a spiralled high tensile textile cord & flexible helix wire reinforcement. This hose is weather & ozone resistant. The service temperature range is -22°F to 176°F. Available for purchase by the foot or by the coil.

Part No.	Nom. I.D.	Nom. O.D.	Working PSI	Coil Length	Price / Ft.	Price / Coil
T202AA200X100	2"	2.40"	150	100'	\$5.95	\$595.00
T202AA300X100	3"	3.46"	150	100'	\$9.51	\$951.00
T202AA400X100	4"	4.49"	150	100'	\$13.78	\$1,378.00
T204AA600X25	6"	6.54"	75	25'	\$25.36	\$634.00
T204AA600X50	6"	6.54"	75	50'	\$25.36	\$1,268.00
T204AA600X100	6"	6.54"	75	100'	\$25.36	\$2,536.00
T204AA800X25	8"	8.70"	75	25'	\$40.79	\$1,019.75
T253AA1000X50	10"	10.71"	150	50'	\$73.10	\$3,655.00
T253AA1200X50	12"	12.87"	150	50'	\$129.63	\$6,481.50



KURIYAMA ALFAGOMMA® BLACK PETROLEUM SUCTION & DISCHARGE HOSE

This hose is for suction & discharge applications in truck & tank car transfer of gasoline, oil & other petroleum based products with up to 50% aromatic content. The hose construction is of black conductive NBR for the tube, high tensile textile cord & 4 highly flexible steel helix wire reinforcement, & abrasion & ozone resistant black nitrile PVC for the cover. The service temperature range is -40°F to 212°F. All sizes are available in 100' coils, and may be purchased by the foot or by the coil.

Part No.	Nominal I.D.	Nominal O.D.	Working PSI	Price / Ft.	Price / Coil
T605AA200X100	2"	2.44"	150	\$9.13	\$913.00
T605AA300X100	3"	3.46"	150	\$16.14	\$1,614.00



Note: WORKING PRESSURE FOR ALL HOSE LISTED ON THIS PAGE IS BASED ON OPERATION AT 70°F.

CAM LEVER FITTINGS

POLYPROPYLENE QUICK-ACTING FITTINGS



TYPE A -
Male Adapter x FIPT

Part No.	Size	Price
FS-PP-A050	1/2" x 1/2"	\$2.64
FS-PP-A075	3/4"	\$2.64
FS-PP-A100	1"	\$3.25
FS-PP-A125	1-1/4"	\$4.78
FS-PP-A150	1-1/2"	\$4.98
FS-PP-A200	2"	\$5.99
FS-PP-A300	3"	\$10.61
FS-PP-A400	4"	\$23.48



TYPE B -
Female Coupler x MIPT

Part No.	Size	Price
FS-PP-B050	1/2" x 1/2"	\$8.76
FS-PP-B075	3/4"	\$8.76
FS-PP-B100	1"	\$9.37
FS-PP-B125	1-1/4"	\$13.31
FS-PP-B150	1-1/2"	\$14.37
FS-PP-B200	2"	\$17.24
FS-PP-B300	3"	\$26.46
FS-PP-B400	4"	\$45.35



TYPE C -
Female Coupler x Hose Shank

Part No.	Size	Price
FS-PP-C050	1/2" x 1/2"	\$8.76
FS-PP-C075	3/4"	\$8.76
FS-PP-C100	1"	\$9.57
FS-PP-C125	1-1/4"	\$13.16
FS-PP-C150	1-1/2"	\$14.37
FS-PP-C200	2"	\$17.39
FS-PP-C300	3"	\$26.76
FS-PP-C400	4"	\$46.91



TYPE D -
Female Coupler x FIPT

Part No.	Size	Price
FS-PP-D050	1/2" x 1/2"	\$8.69
FS-PP-D075	3/4"	\$9.08
FS-PP-D100	1"	\$10.14
FS-PP-D125	1-1/4"	\$14.05
FS-PP-D150	1-1/2"	\$15.58
FS-PP-D200	2"	\$17.83
FS-PP-D300	3"	\$28.00
FS-PP-D400	4"	\$49.11



TYPE E -
Male Adapter x Hose Shank

Part No.	Size	Price
FS-PP-E050	1/2" x 1/2"	\$3.06
FS-PP-E075	3/4"	\$3.06
FS-PP-E100	1"	\$3.61
FS-PP-E125	1-1/4"	\$5.16
FS-PP-E150	1-1/2"	\$5.37
FS-PP-E200	2"	\$5.56
FS-PP-E300	3"	\$10.76
FS-PP-E400	4"	\$21.33



TYPE F -
Male Adapter x MIPT

Part No.	Size	Price
FS-PP-F050	1/2" x 1/2"	\$3.06
FS-PP-F075	3/4"	\$3.06
FS-PP-F100	1"	\$3.40
FS-PP-F125	1-1/4"	\$4.82
FS-PP-F150	1-1/2"	\$5.13
FS-PP-F200	2"	\$5.56
FS-PP-F300	3"	\$11.84
FS-PP-F400	4"	\$21.33



TYPE DC -
Dust Cap

Part No.	Size	Price
FS-PP-DC050	1/2" x 1/2"	\$8.76
FS-PP-DC075	3/4"	\$8.76
FS-PP-DC100	1"	\$8.97
FS-PP-DC125	1-1/4"	\$12.54
FS-PP-DC150	1-1/2"	\$13.61
FS-PP-DC200	2"	\$16.79
FS-PP-DC300	3"	\$24.65
FS-PP-DC400	4"	\$40.35



TYPE DP -
Dust Plug

Part No.	Size	Price
FS-PP-DP050	1/2" x 1/2"	\$2.87
FS-PP-DP075	3/4"	\$2.87
FS-PP-DP100	1"	\$3.11
FS-PP-DP125	1-1/4"	\$3.56
FS-PP-DP150	1-1/2"	\$3.77
FS-PP-DP200	2"	\$5.07
FS-PP-DP300	3"	\$9.25
FS-PP-DP400	4"	\$16.00



TYPE D90 -
90° Female Coupler x FIPT

Part No.	Size	Price
150D90	1-1/2"	\$21.93
200D90	2"	\$26.00



TYPE A90 -
90° Male Adapter x FIPT

Part No.	Size	Price
150A90	1-1/2"	\$10.28
200A90	2"	\$11.80



TYPE F90 -
90° Male Adapter x MIPT

Part No.	Size	Price
150F90	1-1/2"	\$12.41
200F90	2"	\$13.16



TYPE C90 -
90° Female Coupler x Hose Shank

Part No.	Size	Price
150C90	1-1/2"	\$21.93
200C90	2"	\$26.00

CAM LEVER FITTINGS

ALUMINUM QUICK-ACTING FITTINGS



TYPE A -
Male Adapter x FIPT

Part No.	Size	Price
AL-A050	1/2" x 1/2"	\$4.73
AL-A075	3/4"	\$4.73
AL-A100	1"	\$5.85
AL-A125	1-1/4"	\$7.88
AL-A150	1-1/2"	\$5.94
AL-A200	2"	\$7.20
AL-A250	2-1/2"	\$13.56
AL-A300	3"	\$12.85
AL-A400	4"	\$21.86
AL-A600	6"	\$50.69
AL-A800	8"	\$174.80



TYPE B -
Female Coupler x MIPT

Part No.	Size	Price
AL-B050	1/2" x 1/2"	\$9.45
AL-B075	3/4"	\$10.11
AL-B100	1"	\$12.38
AL-B125	1-1/4"	\$15.00
AL-B150	1-1/2"	\$14.45
AL-B200	2"	\$18.19
AL-B250	2-1/2"	\$25.70
AL-B300	3"	\$28.88
AL-B400	4"	\$36.91
AL-B600	6"	\$88.83
AL-B800	8"	\$277.20



TYPE C -
Female Coupler x Hose Shank

Part No.	Size	Price
AL-C050	1/2" x 1/2"	\$7.73
AL-C075	3/4"	\$7.48
AL-C100	1"	\$10.15
AL-C125	1-1/4"	\$14.95
AL-C150	1-1/2"	\$13.74
AL-C200	2"	\$17.12
AL-C250	2-1/2"	\$23.75
AL-C300	3"	\$28.76
AL-C400	4"	\$42.86
AL-C600	6"	\$106.34
AL-C800	8"	\$325.06



TYPE D -
Female Coupler x FIPT

Part No.	Size	Price
AL-D050	1/2" x 1/2"	\$12.40
AL-D075	3/4"	\$11.00
AL-D100	1"	\$12.38
AL-D125	1-1/4"	\$16.90
AL-D150	1-1/2"	\$15.51
AL-D200	2"	\$19.58
AL-D250	2-1/2"	\$28.60
AL-D300	3"	\$28.88
AL-D400	4"	\$43.02
AL-D600	6"	\$98.79
AL-D800	8"	\$289.72



TYPE E -
Male Adapter x Hose Shank

Part No.	Size	Price
AL-E050	1/2" x 1/2"	\$4.53
AL-E075	3/4"	\$4.78
AL-E100	1"	\$5.58
AL-E125	1-1/4"	\$8.62
AL-E150	1-1/2"	\$6.64
AL-E200	2"	\$8.57
AL-E250	2-1/2"	\$14.47
AL-E300	3"	\$18.14
AL-E400	4"	\$26.91
AL-E600	6"	\$38.08
AL-E800	8"	\$192.20



TYPE F -
Male Adapter x MIPT

Part No.	Size	Price
AL-F050	1/2" x 1/2"	\$7.03
AL-F075	3/4"	\$6.15
AL-F100	1"	\$7.32
AL-F125	1-1/4"	\$10.68
AL-F150	1-1/2"	\$7.61
AL-F200	2"	\$9.82
AL-F250	2-1/2"	\$17.85
AL-F300	3"	\$18.91
AL-F400	4"	\$29.13
AL-F600	6"	\$73.60
AL-F800	8"	\$194.04



TYPE DC -
Dust Cap

Part No.	Size	Price
AL-DC050	1/2" x 1/2"	\$8.74
AL-DC075	3/4"	\$8.97
AL-DC100	1"	\$10.89
AL-DC125	1-1/4"	\$16.47
AL-DC150	1-1/2"	\$12.35
AL-DC200	2"	\$14.95
AL-DC250	2-1/2"	\$20.09
AL-DC300	3"	\$23.28
AL-DC400	4"	\$32.40
AL-DC600	6"	\$76.43
AL-DC800	8"	\$261.43



TYPE DP -
Dust Plug

Part No.	Size	Price
AL-DP050	1/2" x 1/2"	\$4.55
AL-DP075	3/4"	\$5.41
AL-DP100	1"	\$5.29
AL-DP125	1-1/4"	\$6.81
AL-DP150	1-1/2"	\$4.78
AL-DP200	2"	\$6.01
AL-DP250	2-1/2"	\$12.30
AL-DP300	3"	\$10.04
AL-DP400	4"	\$17.74
AL-DP600	6"	\$41.19
AL-DP800	8"	\$125.69



TYPE DXA -
Reducing Coupler / Adapter

Part No.	Size	Price
RDA-A2030	2" x 3"	\$38.98
RDA-A3020	3" x 2"	\$43.71
RDA-A3040	3" x 4"	\$61.43
RDA-A4020	4" x 2"	\$61.43
RDA-A4030	4" x 3"	\$61.43
RDA-A6040	6" x 4"	\$137.03

Note: Dust caps & dust plugs are not designed for pressure applications.

HOSE BARB KING NIPPLES & MENDERS



HOSE BARB KING COMBINATION NIPPLES - MALE PIPE THREAD END

Size	Plated Steel	
	Part No.	Price
1/2"	SPN050	\$2.39
3/4"	SPN075	\$2.46
1"	SPN100	\$2.94
1-1/4"	SPN125	\$3.77
1-1/2"	SPN150	\$4.56
2"	SPN200	\$5.72
2-1/2"	SPN250	\$10.70
3"	SPN300	\$13.33
4"	SPN400	\$20.18
5"	STC50	NA
6"	SPN600	\$59.76
8"	SPN800	\$118.41

Size	316 Stainless Steel	
	Part No.	Price
1/2"	SSN050	\$7.77
3/4"	SSN075	\$12.24
1"	SSN100	\$18.11
1-1/4"	SSN125	\$22.06
1-1/2"	SSN150	\$34.44
2"	SSN200	\$40.17
2-1/2"	SSN250	\$68.23
3"	SSN300	\$85.44
4"	SSN400	\$130.08
5"	SSN500	\$350.71
6"	SSN600	\$395.35
8"	RST80	NA

Size	Black Steel	
	Part No.	Price
1/2"	STN050	\$2.34
3/4"	STN075	\$2.40
1"	STN100	\$2.85
1-1/4"	STN125	\$3.71
1-1/2"	STN150	\$4.48
2"	STN200	\$5.63
2-1/2"	STN250	\$10.55
3"	STN300	\$13.12
4"	STN400	\$19.91
5"	STN500	\$47.77
6"	STN600	\$59.20
8"	ST80	NA

HOSE BARB HOSE MENDER

Size	Plated Steel	
	Part No.	Price
3/8"	DMB	Call
1/2"	SPHM050	\$2.06
5/8"	SPHM062	\$2.32
3/4"	SPHM075	\$2.45
1"	SPHM100	\$2.76
1-1/4"	SPHM125	\$3.77
1-1/2"	SPHM150	\$5.01
2"	SPHM200	\$6.19
2-1/2"	SPHM250	\$9.82
3"	SPHM300	\$13.66
4"	SPHM400	\$21.25
5"	DM51	NA
6"	SPHM600	\$61.22
8"	SPHM800	\$129.17

RAINBOW TRAVELER SOFT HOSE MENDER

Size	Plated Steel	
	Part No.	Price
4-1/2"	RBM-17121	\$142.50
4"	RBM-17932	\$112.50

CLAMPS

NOTE: Clamp sizes listed are generic & are intended only as a guide to direct you to the general area of the clamp size you're looking for. To select the proper clamp for your needs, compare the hose OD to the clamp range & select the clamp that best fits the outside diameter of your hose. If you would like some help with your selection, please give us a call.

PINCH CLAMPS

Part No.	Reference No.	Size	Range Closed - Open		Price
15500007	145R	9/16"	.496"	.571"	Call
15500071	152R	19/32"	.496"	.598"	Call
15500008	157R	5/8"	.543"	.618"	Call
15500072	165R	21/32"	.547"	.650"	Call
15500009	170R	11/16"	.595"	.669"	Call
15500010	185R	23/32"	.618"	.728"	Call
15500011	198R	3/4"	.669"	.780"	Call
15500012	210R	13/16"	.717"	.827"	Call
15500013	226R	7/8"	.780"	.890"	Call
15500014	241R	15/16"	.839"	.949"	Call
15500015	256R	1"	.898"	1.008"	Call
15500016	271R	1-1/16"	.945"	1.067"	Call
15500017	286R	1-1/8"	1.004"	1.126"	Call
15500018	301R	1-3/16"	1.063"	1.185"	Call
15500019	316R	1-1/4"	1.122"	1.244"	Call
15500020	331R	1-5/16"	1.181"	1.303"	Call
15500021	346R	1-3/8"	1.240"	1.362"	Call
15500022	361R	1-7/16"	1.299"	1.421"	Call
15500023	376R	1-15/32"	1.358"	1.480"	Call
15500024	381R	1-1/2"	1.378"	1.500"	Call
15500025	396R	1-9/16"	1.437"	1.559"	Call
15500026	410R	1-5/8"	1.492"	1.614"	Call
15500027	425R	1-11/16"	1.551"	1.673"	Call
Additional size available upon request.					

1-Ear stainless clamp with mechanical interlock.



PINCH TOOLS

Part No.	Description	Qty. / Box	Price
14100082	Standard Jaw Pincers	6	Call



MURRAY GOLD SEAL® WORM GEAR HOSE CLAMPS

Part No.	Reference No.	Size	Clamping Range		Price
H600C	H6	1/2"	.44"	.78"	Call
H800C	H8	5/8"	.44"	.91"	Call
H1000C	H10	3/4"	.56"	1.06"	Call
H1200C	H12	1"	.69"	1.25"	Call
H1600C	H16	1-1/8"	.75"	1.50"	Call
H2000C	H20	1-1/4"	.81"	1.75"	Call
H2400C	H24	1-1/2"	1.06"	2.00"	Call
H2800C	H28	1-3/4"	1.31"	2.25"	Call
H3200C	H32	2"	1.56"	2.50"	Call
H3600C	H36	2-1/4"	1.81"	2.75"	Call
H4000C	H40	2-1/2"	2.06"	3.00"	Call
H4400C	H44	2-3/4"	2.31"	3.25"	Call

This is a good general purpose worm gear hose clamp, with a perforated band and gold colored screw. The band & housing are 200/300 series stainless steel. The screw is 5/16" slotted hex head, heat treated carbon steel, double plated for lasting protection.



CLAMPCO T-BOLT CLAMPS

Part No.	Size	Clamping Range		Price
94100-0125	1-1/4"	1.11"	1.25"	\$5.03
94100-0150	1-1/2"	1.36"	1.50"	\$5.03
94100-0162	1-1/2"	1.48"	1.62"	\$5.03
94100-0175	1-1/2"	1.62"	1.87"	\$5.03
94100-0188	1-1/2"	1.75"	2.00"	\$5.03
94100-0200	2"	1.87"	2.12"	\$5.03
94100-0225	2"	2.06"	2.37"	\$5.03
94100-0238	2"	2.19"	2.50"	\$5.03
94100-0250	2-1/2"	2.31"	2.62"	\$4.87
94100-0275	2-1/2"	2.56"	2.87"	\$4.87
94100-0288	2-1/2"	2.66"	2.97"	\$4.87
94100-0300	3"	2.78"	3.09"	\$4.87
94100-0312	3"	2.90"	3.21"	\$4.87
94100-0325	3"	3.03"	3.34"	\$4.87
94100-0350	3"	3.28"	3.59"	\$4.87
94100-0375	3"	3.53"	3.84"	\$4.87
95130-0400	4"	3.75"	4.15"	\$9.86
95130-0425	4"	4.00"	4.40"	\$9.86
95130-0450	4-1/2"	4.25"	4.65"	\$9.86
95130-0475	4-1/2"	4.50"	4.90"	\$9.86
95130-0488	4-1/2"	4.63"	5.03"	\$9.86
95130-0500	5"	4.75"	5.15"	\$10.06
95130-0525	5"	5.00"	5.40"	\$10.06
95130-0531	5"	5.06"	5.46"	\$10.06
95130-0550	5-1/2"	5.25"	5.65"	\$10.06
95130-0556	5-1/2"	5.31"	5.71"	\$10.06
95130-0575	5-1/2"	5.55"	5.90"	\$10.06
95130-0600	5-9/16"	5.75"	6.15"	\$10.53
95130-0618	6"	5.93"	6.33"	\$10.53
95130-0625	6"	6.00"	6.40"	\$10.53
95130-0644	6"	6.19"	6.59"	\$10.70
95130-0650	6-1/2"	6.25"	6.65"	\$10.70
95130-0656	6-1/2"	6.31"	6.71"	\$10.70
95130-0675	6-1/2"	6.50"	6.90"	\$10.73
95130-0688	6-1/2"	6.63"	7.03"	\$10.80
95130-0700	6-5/8"	6.75"	7.15"	\$10.90
95130-0706	6-5/8"	6.81"	7.21"	\$10.90
95130-0712	6-5/8"	6.87"	7.27"	\$10.90
95130-0725	6-5/8"	7.00"	7.40"	\$10.90
95130-0800	8"	7.75"	8.15"	\$11.73
95130-0844	8"	8.19"	8.59"	\$11.76
95130-0850	8-1/2"	8.25"	8.65"	\$11.76
95130-0856	8-1/2"	8.31"	8.71"	\$11.80
95130-0862	8-1/2"	8.37"	8.77"	\$11.87
95130-0870	8-1/2"	8.45"	8.85"	\$11.93
95130-0890	8-1/2"	8.65"	9.05"	\$12.03
95130-0918	8-5/8"	8.93"	9.33"	\$12.07
95130-0925	8-5/8"	9.00"	9.40"	\$12.53
95130-1044	10"	10.19"	10.59"	\$12.63
95130-1062	10"	10.37"	10.77"	\$12.77
95130-1075	10-3/4"	10.50"	10.90"	\$12.90
95130-1079	10-3/4"	10.54"	10.94"	\$12.93
95130-1090	10-3/4"	10.65"	11.05"	\$13.10



Good for medium & heavy-duty applications. Provides high tensile strength - higher clamping force than worm gear clamps. Manufactured with durable & corrosion resistant 300 series stainless steel. The solid band with rounded edges prevents damage from hose extrusion.

94100 Series clamp has a 3/4" wide band & 1/4" zinc plated T-Bolt with locknut.

95130 Series clamp has a 7/8" wide band & 5/16" zinc plated T-bolt with locknut.

REPLACEMENT NATIONAL FINE NYLON LOCK NUTS



Part No.	Size	Series	Price
NLN1/428	1/4"	94100	\$0.42
NLN5/1624	5/16"	95130	\$0.50

CENTER PUNCH CLAMPS

Part No.	Size	Price
CPSS04	1"	\$1.85
CPSS05	1-1/4"	\$1.99
CPSS06	1-1/2"	\$2.07
CPSS07	1-3/4"	\$2.26
CPSS08	2"	\$2.43
CPSS09	2-1/4"	\$2.51
CPSS10	2-1/2"	\$2.77
CPSS11	2-3/4"	\$2.90
CPSS12	3"	\$3.06
CPSS14	3-1/2"	\$3.40
CPSS16	4"	\$3.78
CPSS18	4-1/2"	\$4.10
CPSS20	5"	\$4.46
CPSS24	6"	\$5.09
CPSS28	7"	\$5.71
CPSS32	8"	\$6.34
Use with T30069 hand tool.		\$326.03

These universal preformed clamps are manufactured from 5/8" wide - .031" thick 300 series stainless steel for the clamp band & 302 series stainless steel for the clamp buckle.



SPIRAL DOUBLE BOLT CLAMPS

Part No.	Size	Price
SDBC-105	1-1/2"	\$5.48
SDBC-2	2"	\$6.21
SDBC-2.25	2-1/4"	\$6.78
SDBC-2.5	2-1/2"	\$7.20
SDBC-3	3"	\$7.88
SDBC-3.5	3-1/2"	\$8.91
SDBC-4	4"	\$9.72
SDBC-5	5"	\$12.24
SDBC-6	6"	\$16.19
SDBC-8	8"	\$21.93
SDBC-10	10"	\$24.66
SDBC-12	12"	\$34.58

Zinc plated carbon steel clamps for counterclockwise spiral. Specifically designed to fit PVC & rubber suction hose.



DUCTILE IRON DOUBLE BOLT CLAMPS

Part No.	Clamping Range		Price
DB76	2.3750"	3.0156"	\$5.73
DB94	3.0312"	3.6875"	\$9.54
DB400	3.5000"	4.0000"	\$11.57
DB463	4.0625"	4.4375"	\$12.07
DB525	4.1875"	5.0000"	\$15.92
DB550	5.0000"	5.5000"	\$15.92
DB600	5.5000"	6.0625"	\$18.68
DB675	6.1250"	6.8750"	\$20.68
DB769	6.9375"	7.6250"	\$23.68
DB818	7.6875"	8.1875"	\$34.52
DB875	8.2500"	8.8750"	\$37.09
DB988	8.9375"	9.8750"	\$39.66
DB1125	9.9375"	11.3750"	\$65.60
DB1275	11.1875"	13.0000"	\$75.49
DB1360	12.1875"	14.0000"	\$102.93

A rugged, zinc plated ductile iron two bolt clamp with side saddles, machine bolts & hex nuts. Inner surface has dual gripping ridges. Bolt lugs are reinforced to prevent bending out of alignment.



Injectors / Filters

Section 10

- 4 FLOW GUARD FILTERS
- 5 PLASTIC FILTERS
- 6-7 HIGH FLOW STEEL SCREEN FILTERS
- 8 AGRI-INJECT FERTILIZER SYSTEMS
- 9 CHEMIGATION SYSTEMS ACCESSORIES
- 10-11 INJECT-O-METER FERTILIZER SYSTEMS
- 12-13 INJECT-O-METER CHEMIGATION SYSTEMS
- 14 INJECTION EQUIPMENT
- 15 CAM LEVER FITTINGS



FRESNO FLOW-GUARD GALVANIZED SCREEN 1500 SERIES

8"/1200 GPM WITH 1/16" SCREEN

Part No.	Inlet	Outlet	Price
P3821-01	Victaulic	Victaulic	\$2,610.00
P3821-02	Flange	Flange	\$2,418.00
P3821-03	Plain End	Plain End	\$2,238.00
P3821-04	Ringlock Male	Ringlock Bell	\$2,718.00



8"/1200 GPM WITH 3/32" SCREEN

Part No.	Inlet	Outlet	Price
P3821-21	Victaulic	Victaulic	\$2,430.00
P3821-22	Flange	Flange	\$2,274.00
P3821-23	Plain End	Plain End	\$2,130.00
P3821-24	Ringlock Male	Ringlock Bell	\$2,550.00



8"/1200 GPM WITH 3/32" SCREEN CENTER FEED

Part No.	Inlet	Outlet	Price
P3821-47	Victaulic	Victaulic	Call
P3821-48	Flange	Flange	Call
P3821-49	Plain End	Plain End	Call
P3821-50	Ringlock Male	Ringlock Bell	Call



8"/1200 GPM WITH 1/16" SCREEN CENTER FEED WITH LEGS

Part No.	Inlet	Outlet	Price
P0074-60	Ringlock Male	Ringlock Bell	Call

8"/1200 GPM WITH 3/32" SCREEN CENTER FEED WITH LEGS

Part No.	Inlet	Outlet	Price
P0073-82	Ringlock Male	Ringlock Bell	Call

8"/1750 GPM WITH 1/16" SCREEN

Part No.	Inlet	Outlet	Price
P3850-01	Victaulic	Victaulic	\$4,027.20
P3850-02	Flange	Flange	\$4,110.00
P3850-03	Plain End	Plain End	\$3,988.80
P3850-04	Ringlock Male	Ringlock Bell	\$4,228.80



8"/1750 GPM WITH 3/32" SCREEN

Part No.	Inlet	Outlet	Price
P3850-11	Victaulic	Victaulic	\$3,678.00
P3850-12	Flange	Flange	\$3,576.00
P3850-13	Plain End	Plain End	\$3,588.00
P3850-14	Ringlock Male	Ringlock Bell	\$3,513.60

Note: 1750 GPM filters use two screens each.

JAIN® PLASTIC FILTERS

3/4" 4-EH SERIES PLASTIC FILTER (MIPT) W/ FLUSH & BALL VALVE

Part No.	Model	Max Flow GPM	Screen Mesh	Max PSI	Price
12130118	4EH-3/4B-30	9	30	150	\$59.71
12130119	4EH-3/4B-50	9	50	150	\$59.71
12130115	4EH-3/4B-100	9	100	150	\$59.71
12130116	4EH-3/4B-150	9	150	150	\$59.71
12130117	4EH-3/4B-200	9	200	150	\$59.71

1" 4-EH SERIES PLASTIC FILTER (MIPT) W/ FLUSH & BALL VALVE

Part No.	Model	Max Flow GPM	Screen Mesh	Max PSI	Price
12130201	4EH-1B-30	18	30	150	\$63.86
12130203	4EH-1B-50	18	50	150	\$63.86
12130205	4EH-1B-100	18	100	150	\$63.86
12130207	4EH-1B-150	18	150	150	\$63.86
12130209	4EH-1B-200	18	200	150	\$63.86

1-1/2" 4-EH SERIES PLASTIC FILTER (MIPT) W/ FLUSH & BALL VALVE

Part No.	Model	Max Flow GPM	Screen Mesh	Max PSI	Price
12130093	4EH-1-1/2-30	55	30	150	\$419.52
12130094	4EH-1-1/2-50	55	50	150	\$419.52
12130090	4EH-1-1/2-100	55	100	150	\$419.52
12130091	4EH-1-1/2-150	55	150	150	\$419.52
12130092	4EH-1-1/2-200	55	200	150	\$419.52

2" 4-EH SERIES PLASTIC FILTER (MIPT) W/ FLUSH & BALL VALVE

Part No.	Model	Max Flow GPM	Screen Mesh	Max PSI	Price
12130108	4EH-2P-30	110	30	150	\$461.47
12130109	4EH-2P-50	110	50	150	\$461.47
12130105	4EH-2P-100	110	100	150	\$461.47
12130106	4EH-2P-150	110	150	150	\$461.47
12130107	4EH-2P-200	110	200	150	\$461.47

3/4" 4-E SERIES PLASTIC FILTER (MIPT) W/ FLUSH & BALL VALVE

Part No.	Model	Max Flow GPM	Screen Mesh	Max PSI	Price
12130079	4E-3/4B-30	9	30	80	\$44.12
12130080	4E-3/4B-50	9	50	80	\$44.12
12130076	4E-3/4B-100	9	100	80	\$44.12
12130077	4E-3/4B-150	9	150	80	\$44.12
12130078	4E-3/4B-200	9	200	80	\$44.12

1" 4-E SERIES PLASTIC FILTER (MIPT) W/ FLUSH & BALL VALVE

Part No.	Model	Max Flow GPM	Screen Mesh	Max PSI	Price
12130181	4E-1BN-30	18	30	80	\$45.28
12130183	4E-1BN-50	18	50	80	\$45.28
12130185	4E-1BN-100	18	100	80	\$45.28
12130187	4E-1BN-150	18	150	80	\$45.28
12130189	4E-1BN-200	18	200	80	\$45.28

These Spin Clean® filters are unique in that incoming water is forced through a directional nozzle plate onto the inside of the all stainless steel filter screen. This centrifugal control of the contaminated water helps prevent debris build up on the filter screen by constantly rotating the particles and forcing them toward the debris holding basin at the bottom of the filter. By opening the flush valve periodically, the particles can be removed, or the 4E can be made self cleaning by constantly bleeding the contaminates through the flush valve which has been set slightly open.



JAIN® 4-E HIGH FLOW STEEL SCREEN FILTERS

2" 4-E SERIES FLANGED STEEL FILTER

Part No.	Model	Max Flow GPM	Screen Mesh	Price
13150027	4E-2-30F	103	30	\$3,668.20
13150029	4E-2-50F	103	50	\$3,668.20
13150013	4E-2-100F	103	100	\$3,668.20
13150017	4E-2-150F	103	150	\$3,668.20
13150022	4E-2-200F	103	200	\$3,668.20

Features

- No moving parts.
- Unique Spin Clean® action helps keep the screen clean.
- All welded steel housing.
- Scotchkote™ #306 fusion bond epoxy coating.
- Bonded three layer stainless steel screen.
- No backwashing down time.
- Easy screen accessibility.
- 150 PSI maximum operating pressure.
- Includes pressure check device & air vent.

3" 4-E SERIES FLANGED STEEL FILTER

Part No.	Model	Max Flow GPM	Screen Mesh	Price
13150045	4E-3-30F	210	30	\$4,147.61
13150047	4E-3-50F	210	50	\$4,147.61
13150032	4E-3-100F	210	100	\$4,147.61
13150037	4E-3-150F	210	150	\$4,147.61
13150041	4E-3-200F	210	200	\$4,147.61

4" 4-E SERIES FLANGED STEEL FILTER

Part No.	Model	Max Flow GPM	Screen Mesh	Price
13150062	4E-4-30F	365	30	\$4,429.09
13150064	4E-4-50F	365	50	\$4,429.09
13150052	4E-4-100F	365	100	\$4,429.09
13150056	4E-4-150F	365	150	\$4,429.09
13150059	4E-4-200F	365	200	\$4,429.09



6" 4-E SERIES FLANGED STEEL FILTER

Part No.	Model	Max Flow GPM	Screen Mesh	Price
13150072	4E-6-30F	550	30	\$6,161.65
13150073	4E-6-50F	550	50	\$6,161.65
13150067	4E-6-100F	550	100	\$6,161.65
13150069	4E-6-150F	550	150	\$6,161.65
13150071	4E-6-200F	550	200	\$6,161.65

6" 4-E SERIES HIGH FLOW FLANGED STEEL FILTER

Part No.	Model	Max Flow GPM	Screen Mesh	Price
13150078	4E-6HF-30F	1000	30	\$10,527.76
13150079	4E-6HF-50F	1000	50	\$10,527.76
13150075	4E-6HF-100F	1000	100	\$10,527.76
13150076	4E-6HF-150F	1000	150	\$10,527.76
13150077	4E-6HF-200F	1000	200	\$10,527.76

Note: 2", 3" and 4" 4-E Series Filters are available for order with grooved ends. Please Call for pricing and availability.

8" 4-E SERIES FLANGED STEEL FILTER

Part No.	Model	Max Flow GPM	Screen Mesh	Price
13150083	4E-8-30F	1300	30	\$11,590.69
13150084	4E-8-50F	1300	50	\$11,590.69
13150080	4E-8-100F	1300	100	\$11,590.69
13150081	4E-8-150F	1300	150	\$11,590.69
13150082	4E-8-200F	1300	200	\$11,590.69

10" 4-E SERIES FLANGED STEEL FILTER

Part No.	Model	Max Flow GPM	Screen Mesh	Price
13150004	4E-10-30F	2200	30	\$16,979.89
13150005	4E-10-50F	2200	50	\$16,979.89
13150001	4E-10-100F	2200	100	\$16,979.89
13150002	4E-10-150F	2200	150	\$16,979.89
13150003	4E-10-200F	2200	200	\$16,979.89

FRESNO FLOW-GUARD 1600 SERIES SAND SEPARATOR

Model No.	Part No.	GPM	Inlet / Outlet	Pad Size (In) W x L	Price
3103	P3950-01	70-200	3"	18" x 30"	\$1,905.00
3204	P3950-02	140-400	4"	36" x 36"	\$2,850.00
3306	P3950-03	210-600	6"	36" x 54"	\$4,116.00
3406	P3950-04	280-800	6"	36" x 72"	\$5,268.00
4104	P3950-05	200-400	4"	18" x 30"	\$1,980.00
4206	P3950-06	400-800	6"	36" x 36"	\$3,588.00
4308	P3950-07	600-1200	8"	36" x 54"	\$5,220.00
4408	P3950-08	800-1600	8"	36" x 72"	\$6,510.00



AGRI-INJECT FERTILIZER INJECTION SYSTEM

18 GPH MROY A SIMPLEX FERTILIZER SYSTEM

Part No.	Description	Price
881-01-111018-0	Complete System w/Switch, Strainer, Mister Mist'r, 1PH	Call
881-02-111018-0	Complete System w/Switch, Strainer, Mister Mist'r, 12V	Call
881-03-111018-0	Complete System w/Switch, Strainer, Mister Mist'r, 3PH	Call

26 GPH MROY D SIMPLEX FERTILIZER SYSTEM

Part No.	Description	Price
881-01-111026-0	Complete System w/Switch, Strainer, Mister Mist'r, 1PH	Call
881-02-111026-0	Complete System w/Switch, Strainer, Mister Mist'r, 12V	Call
881-03-111026-0	Complete System w/Switch, Strainer, Mister Mist'r, 3PH	Call

30 GPH MROY A SIMPLEX FERTILIZER SYSTEM

Part No.	Description	Price
881-01-111030-0	Complete System w/Switch, Strainer, Mister Mist'r, 1PH	Call
881-02-111030-0	Complete System w/Switch, Strainer, Mister Mist'r, 12V	Call
881-03-111030-0	Complete System w/Switch, Strainer, Mister Mist'r, 3PH	Call

52 GPH MROY D SIMPLEX FERTILIZER SYSTEM

Part No.	Description	Price
881-01-111052-0	Complete System w/Switch, Strainer, Mister Mist'r, 1PH	Call
881-02-111052-0	Complete System w/Switch, Strainer, Mister Mist'r, 12V	Call
881-03-111052-0	Complete System w/Switch, Strainer, Mister Mist'r, 3PH	Call

55 GPH MROY G SIMPLEX FERTILIZER SYSTEM

Part No.	Description	Price
881-01-111055-0	Complete System w/Switch, Strainer, Mister Mist'r, 1PH	Call
881-02-111055-0	Complete System w/Switch, Strainer, Mister Mist'r, 12V	Call
881-03-111055-0	Complete System w/Switch, Strainer, Mister Mist'r, 3PH	Call

110 GPH MROY G SIMPLEX FERTILIZER SYSTEM

Part No.	Description	Price
881-01-111110-0	Complete System w/Switch, Strainer, Mister Mist'r, 1PH	Call
881-02-111110-0	Complete System w/Switch, Strainer, Mister Mist'r, 12V	Call
881-03-111110-0	Complete System w/Switch, Strainer, Mister Mist'r, 3PH	Call

150 GPH MROY G SIMPLEX FERTILIZER SYSTEM

Part No.	Description	Price
881-01-111150-0	Complete System w/Switch, Strainer, Mister Mist'r, 1PH	Call
881-02-111150-0	Complete System w/Switch, Strainer, Mister Mist'r, 12V	Call
881-03-111150-0	Complete System w/Switch, Strainer, Mister Mist'r, 3PH	Call



AGRI-INJECT MISTER MIST'R® INJECTION CHECK VALVE & ACCESSORIES

MINI MIST'R® - POLY (UP TO 5 GPH)

Part No.	Size	Description	Price
820-02-060000-0	3/4" x 3/8" x 5"	Mini Mist'r Assembly	Call
820-02-000100-0		Mini Mist'r Assembly & Bleeder	Call

"SHORTY" MISTER MIST'R® - POLY - 15 PSI (UP TO 60 GPH)

Part No.	Size	Description	Price
820-02-008128-0	3/4" x 1/4" x 4"	"Shorty" Mister Mist'r®	Call
820-02-000200-0		"Shorty" Mister Mist'r® & Bleeder	Call
820-02-008128-1		"Shorty" Mister Mist'r®, Acid	Call
820-02-000200-1		"Shorty" Mister Mist'r® & Bleeder, Acid	Call

MISTER MIST'R® - POLY - 15 PSI (UP TO 60 GPH)

Part No.	Size	Description	Price
820-02-008000-0	3/4" x 1/4" x 6"	Mister Mist'r®	Call
820-02-000000-0		Mister Mist'r® & Bleeder	Call
820-02-008000-1		Mister Mist'r®, Acid	Call
820-02-000000-1		Mister Mist'r® & Bleeder, Acid	Call

MISTER MIST'R® - STAINLESS STEEL - 20 PSI (UP TO 300 GPH)

Part No.	Size	Description	Price
820-50-016128-0	3/4" x 1/2" x 4"	Mister Mist'r®	Call
820-50-000000-1		Mister Mist'r® & Bleeder	Call
820-50-016256-0	3/4" x 1/2" x 8"	Mister Mist'r®	Call
820-50-000000-0		Mister Mist'r® & Bleeder	Call

MISTER MIST'R® - CPVC - 20 PSI (UP TO 200 GPH)

Part No.	Size	Description	Price
820-01-014256-0	3/4" x 1/2" x 3"	Mister Mist'r®, Acid	Call
820-01-016256-0	3/4" x 1/2" x 6"	Mister Mist'r®, Acid	Call
820-05-000000-0		Mister Mist'r® & Bleeder, Acid	Call

BLEEDER VALVES & FITTINGS

Part No.	Size	Description	Price
821-02-008008-0	1/4"	Bleeder Valve Assembly, PP	Call
821-02-008000-0	1/4"	Bleeder Valve & Fitting Assembly	Call
821-02-008000-A	1/4"	Bleeder Valve & Fitting Assembly, Acid	Call
199-01-012008-1	3/8" x 1/4"	JG Male Connector	Call
199-09-012012-1	3/8" x 3/8"	JG Plug-In Elbow	Call
198-19-012008-0	3/8" x 1/4"	TS Male Connector, Acid	Call
198-19-012012-0	3/8" x 3/8"	TS Plug-In Elbow, Acid	Call
260-02-187125-0	.187" x .125"	Microtube PE, 1 Ft.	Call
821-02-008008-1	1/4"	Bleeder Valve Assembly & Plug	Call
821-01-016000-0	1/2"	Bleeder Valve & Fitting Assembly	Call
821-01-016024-0	1/2" x 3/4"	Bleeder & Fitting Assembly	Call

MISTER MIST'R® HOSE ASSEMBLIES & FITTINGS

Part No.	Size	Description	Price
849-10-008012-0	1/4" x 3/8" x 12'	Hose Kit, High Pressure, Black	Call
849-10-008012-1	1/4" x 3/8" x 20'	Hose Kit, High Pressure, Black	Call
849-10-016012-0	1/2" x 3/8" x 12'	Hose Kit, High Pressure, Black	Call
849-07-016012-0	1/2" x 3/8" x 12'	Hose Kit, Grey Braid	Call
199-13-012008-0	3/8" x 1/4"	JG Male Connector to Hose	Call
199-13-012012-1	3/8" x 3/8"	JG Male Connector to Hose	Call
199-13-012016-1	3/8" x 1/2"	JG Male Connector to Hose	Call
198-19-012008-5	3/8" x 1/4"	TS Male Connector to Hose	Call
198-19-012012-5	3/8" x 3/8"	TS Male Connector to Hose	Call



INJECT-O-METER CHEMIGATION CHECK VALVE

316 Stainless Steel Construction and Viton Seat for Strength and Chemical Resistance
 *Self Cleaning *3 Directional Spray *Meets Federal Requirements



MAX-94 CHEMIGATION CHECK VALVE AND ACCESSORIES

Part No.	Description	Price
049-085	Max-94 Stainless Steel Chemigation Check Valve	Call
011-033	Bleeder Valve for Removing Air from the Line	Call

INJECT-O-METER INJECTION SYSTEMS

INJECT-O-METER - SIMPLEX - SINGLE PHASE

Part No.	Description	Min. GPH Output	Max. GPH Output	Price
IOM-3302	IOM-330 1/3HP 1PH Injector No Hose Kit	3.0	30.0	Call
IOM-3306	IOM-330 1/3HP 1PH Injector w/Hose Kit	3.0	30.0	Call
N/P	I70 (.25) 1/3HP 1PH Injector w/Hose Kit	.20	2.0	Call
001-117	I70 (.375) 1/3HP 1PH Injector w/Hose Kit	.45	4.5	Call
001-129	I70 (.50) 1/3HP 1PH Injector w/Hose Kit	.80	8.0	Call
001-134	I70 (.625) 1/3HP 1PH Injector w/Hose Kit	1.25	12.5	Call
001-011	I70 (.75) 1/3HP 1PH Injector w/Hose Kit	1.80	18.0	Call
014-009	HVI-88 1/3HP 1PH Injector w/Hose Kit	3.0	30.0	Call
007-003	HVI-82 1/3HP 1PH Injector w/Hose Kit	5.7	57.0	Call
015-013	IOM-96 1/3HP 1PH Injector w/Hose Kit	10.0	100.0	Call



INJECT-O-METER - SIMPLEX - 3 PHASE

Part No.	Description	Min. GPH Output	Max. GPH Output	Price
IOM-3301	IOM-330 1/3HP 3PH Injector No Hose Kit	3.0	30.0	Call
IOM-3305	IOM-330 1/3HP 3PH Injector w/Hose Kit	3.0	30.0	Call
001-073	I70 (.25) 1/3HP 3PH Injector w/Hose Kit	.20	2.0	Call
001-119	I70 (.375) 1/3HP 3PH Injector w/Hose Kit	.45	4.5	Call
001-122	I70 (.50) 1/3HP 3PH Injector w/Hose Kit	.80	8.0	Call
001-114	I70 (.625) 1/3HP 3PH Injector w/Hose Kit	1.25	12.5	Call
001-110	I70 (.75) 1/3HP 3PH Injector w/Hose Kit	1.80	18.0	Call
014-024	HVI-88 1/3HP 3PH Injector w/Hose Kit	3.0	30.0	Call
007-044	HVI-82 1/3HP 3PH Injector w/Hose Kit	5.7	57.0	Call
015-017	IOM-96 1/3HP 3PH Injector w/Hose Kit	10.0	100.0	Call

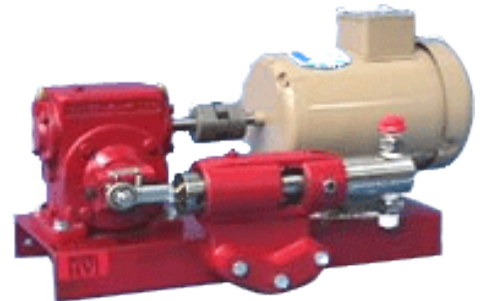

INJECT-O-METER - SIMPLEX - 12V DC

Part No.	Description	Min. GPH Output	Max. GPH Output	Price
001-131	I70 (.25) 1/2HP 12VDC Injector w/o Hose Kit	.20	2.0	Call
001-226	I70 (.375) 1/2HP 12VDC Injector w/Hose Kit	.45	4.5	Call
001-132	I70 (.50) 1/2HP 12VDC Injector w/Hose Kit	.80	8.0	Call
N/P	I70 (.625) 1/2HP 12VDC Injector w/Hose Kit	1.25	12.5	Call
001-034	I70 (.75) 1/2HP 12VDC Injector w/Hose Kit	1.80	18.0	Call
014-027	HVI-88 1/2HP 12VDC Injector w/Hose Kit	3.0	30.0	Call
007-012	HVI-82 3/4HP 12VDC Injector w/Hose Kit	5.7	57.0	Call
015-059	IOM-96 1/2HP 12VDC Injector w/Hose Kit	10.0	100.0	Call



INJECT-O-METER - BELT DRIVEN PUMPS - SIMPLEX @ 1725 RPM

Part No.	Description	Min. GPH Output	Max. GPH Output	Price
001-077	I70 (.25) w/Hose Kit & Mounting Bracket	.20	2.0	Call
001-065	I70 (.375) w/Hose Kit & Mounting Bracket	.45	4.5	Call
001-053	I70 (.50) w/Hose Kit & Mounting Bracket	.80	8.0	Call
001-041	I70 (.625) w/Hose Kit & Mounting Bracket	1.25	12.5	Call
001-004	I70 (.75) w/Hose Kit & Mounting Bracket	1.80	18.0	Call
014-001	HVI-88 w/Hose Kit & Mounting Bracket	3.0	30.0	Call
007-011	HVI-82 w/Hose Kit & Mounting Bracket	5.7	57.0	Call
015-005	IOM-96 w/Hose Kit & Mounting Bracket	7.6	76.0	Call



INJECT-O-METER INJECTION SYSTEMS

INJECT-O-METER - DUPLEX - SINGLE PHASE

Part No.	Description	Min. GPH Output	Max. GPH Output	Price
001-135	I70 (.25) 1/3HP 1 PH Injector w/Hose Kit	.40	4.0	Call
N/P	I70 (.375) 1/3HP 1 PH Injector w/Hose Kit	.90	9.0	Call
001-133	I70 (.50) 1/3HP 1 PH Injector w/Hose Kit	1.6	16.0	Call
N/P	I70 (.625) 1/3HP 1 PH Injector w/Hose Kit	2.5	25.0	Call
001-017	I70 (.75) 1/3HP 1 PH Injector w/Hose Kit	3.6	36.0	Call
014-013	HVI-88 1/3HP 1 PH Injector w/Hose Kit	6.0	60.0	Call
007-047	HVI-82 1/3HP 1 PH Injector w/Hose Kit	11.4	114.0	Call
015-037	IOM-96 1/2HP 1 PH Injector w/Hose Kit	20.0	200.00	Call



INJECT-O-METER - DUPLEX - 3 PHASE

Part No.	Description	Min. GPH Output	Max. GPH Output	Price
001-075	I70 (.25) 1/3HP 3PH Injector w/Hose Kit	.40	4.0	Call
001-063	I70 (.375) 1/3HP 3PH Injector w/Hose Kit	.90	9.0	Call
001-051	I70 (.50) 1/3HP 3PH Injector w/Hose Kit	1.6	16.0	Call
001-039	I70 (.625) 1/3HP 3PH Injector w/Hose Kit	2.5	25.0	Call
001-104	I70 (.75) 1/3HP 3PH Injector w/Hose Kit	3.6	36.0	Call
014-025	HVI-88 1/3HP 3PH Injector w/Hose Kit	6.0	60.0	Call
007-045	HVI-82 1/3HP 3PH Injector w/Hose Kit	11.4	114.0	Call
015-042	IOM-96 1/2HP 3PH Injector w/Hose Kit	20.0	200.00	Call



INJECT-O-METER - DUPLEX - 12V DC

Part No.	Description	Min. GPH Output	Max. GPH Output	Price
N/P	I70 (.25) 1/2HP 12VDC Injector w/Hose Kit	.40	4.0	Call
N/P	I70 (.375) 1/2HP 12VDC Injector w/Hose Kit	.90	9.0	Call
N/P	I70 (.50) 1/2HP 12VDC Injector w/Hose Kit	1.6	16.0	Call
N/P	I70 (.625) 1/2HP 12VDC Injector w/Hose Kit	2.5	25.0	Call
001-036	I70 (.75) 1/2HP 12VDC Injector w/Hose Kit	3.6	36.0	Call
014-026	HVI-88 1/2HP 12VDC Injector w/Hose Kit	6.0	60.0	Call
007-014	HVI-82 3/4HP 12VDC Injector w/Hose Kit	11.4	114.0	Call
015-060	IOM-96 3/4HP 12VDC Injector w/Hose Kit	20.0	200.00	Call



INJECT-O-METER - BELT DRIVEN PUMPS - DUPLEX @ 1725 RPM

Part No.	Description	Min. GPH Output	Max. GPH Output	Price
001-081	I70 (.25) w/Hose Kit & Mounting Bracket	.40	4.0	Call
001-069	I70 (.375) w/Hose Kit & Mounting Bracket	.90	9.0	Call
001-057	I70 (.50) w/Hose Kit & Mounting Bracket	1.6	16.0	Call
001-045	I70 (.625) w/Hose Kit & Mounting Bracket	2.5	25.0	Call
001-005	I70 (.75) w/Hose Kit & Mounting Bracket	3.6	36.0	Call
014-002	HVI-88 w/Hose Kit & Mounting Bracket	6.0	60.0	Call
007-010	HVI-82 w/Hose Kit & Mounting Bracket	11.4	114.0	Call
015-030	IOM-96 w/Hose Kit & Mounting Bracket	15.2	152.0	Call



WE CARRY THE COMPLETE LINE OF INJECT-O-METER WHOLE GOODS AND PARTS, INCLUDING ACID INJECTION PUMPS. IF YOU DO NOT FIND WHAT YOU ARE LOOKING FOR IN THIS SECTION, PLEASE CALL US TO DISCUSS YOUR INDIVIDUAL NEEDS.

INJECT-O-METER CHEMIGATION SYSTEMS

INJECT-O-METER - CHEMIGATION SYSTEM WITH TANK - SIMPLEX - SINGLE PHASE

Part No.	Description	HP	Min. GPH Output	Max. GPH Output	Price
001-180-65-CS	I70 (.25) 1PH 65 Gal. Tank - Mechanical Agitator	1/3	.20	2.00	Call
001-180-110-CS	I70 (.25) 1PH 110 Gal. Tank - Mechanical Agitator	1/3	.20	2.00	Call
001-181-65-CS	I70 (.375) 1PH 65 Gal. Tank - Mechanical Agitator	1/3	.45	4.5	Call
001-181-110-CS	I70 (.375) 1PH 110 Gal. Tank - Mechanical Agitator	1/3	.45	4.5	Call
001-182-65-CS	I70 (.50) 1PH 65 Gal. Tank - Mechanical Agitator	1/3	.80	8.0	Call
001-182-110-CS	I70 (.50) 1PH 110 Gal. Tank - Mechanical Agitator	1/3	.80	8.0	Call
001-183-65-CS	I70 (.625) 1PH 65 Gal. Tank - Mechanical Agitator	1/3	1.25	12.5	Call
001-183-110-CS	I70 (.625) 1PH 110 Gal. Tank - Mechanical Agitator	1/3	1.25	12.5	Call
001-184-65-CS	I70 (.75) 1PH 65 Gal. Tank - Mechanical Agitator	1/3	1.80	18.0	Call
001-184-110-CS	I70 (.75) 1PH 110 Gal. Tank - Mechanical Agitator	1/3	1.80	18.0	Call
007-003-65-CS	HVI-82 1PH 65 Gal. Tank - Mechanical Agitator	1/3	5.70	57.0	Call
007-003-110-CS	HVI-82 1PH 110 Gal. Tank - Mechanical Agitator	1/3	5.70	57.0	Call



INJECT-O-METER - CHEMIGATION SYSTEM WITH TANK - SIMPLEX - 3 PHASE

Part No.	Description	HP	Min. GPH Output	Max. GPH Output	Price
001-175-65-CS	I70 (.25) 3PH 65 Gal. Tank - Mechanical Agitator	1/3	.20	2.00	Call
001-175-110-CS	I70 (.25) 3PH 110 Gal. Tank - Mechanical Agitator	1/3	.20	2.00	Call
001-176-65-CS	I70 (.375) 3PH 65 Gal. Tank - Mechanical Agitator	1/3	.45	4.5	Call
001-176-110-CS	I70 (.375) 3PH 110 Gal. Tank - Mechanical Agitator	1/3	.45	4.5	Call
001-177-65-CS	I70 (.50) 3PH 65 Gal. Tank - Mechanical Agitator	1/3	.80	8.0	Call
001-177-110-CS	I70 (.50) 3PH 110 Gal. Tank - Mechanical Agitator	1/3	.80	8.0	Call
001-178-65-CS	I70 (.625) 3PH 65 Gal. Tank - Mechanical Agitator	1/3	1.25	12.5	Call
001-178-110-CS	I70 (.625) 3PH 110 Gal. Tank - Mechanical Agitator	1/3	1.25	12.5	Call
001-179-65-CS	I70 (.75) 3PH 65 Gal. Tank - Mechanical Agitator	1/3	1.80	18.0	Call
001-179-110-CS	I70 (.75) 3PH 110 Gal. Tank - Mechanical Agitator	1/3	1.80	18.0	Call
007-001-65-CS	HVI-82 3PH 65 Gal. Tank - Mechanical Agitator	1/3	5.70	57.0	Call
007-001-110-CS	HVI-82 3PH 110 Gal. Tank - Mechanical Agitator	1/3	5.70	57.0	Call



INJECT-O-METER CHEMIGATION SYSTEMS

INJECT-O-METER - CHEMIGATION SYSTEM WITH TANK - DUPLEX - SINGLE PHASE

Part No.	Description	HP	Min. GPH Output	Max. GPH Output	Price
001-208-65-CS	I70 (.75) (.25) 1PH 65 Gal. Tank - Mechanical Agitator & Discharge Kit	1/3	.20	20.0	Call
001-208-110-CS	I70 (.75) (.25) 1PH 110 Gal. Tank - Mechanical Agitator & Discharge Kit	1/3	.20	20.0	Call
001-207-65-CS	I70 (.75) (.375) 1PH 65 Gal. Tank - Mechanical Agitator & Discharge Kit	1/3	.45	22.5	Call
001-207-110-CS	I70 (.75) (.375) 1PH 110 Gal. Tank - Mechanical Agitator & Discharge Kit	1/3	.45	22.5	Call
001-222-65-CS	I70 (.75) (.50) 1PH 65 Gal. Tank - Mechanical Agitator & Discharge Kit	1/3	.80	26.0	Call
001-222-110-CS	I70 (.75) (.50) 1PH 110 Gal. Tank - Mechanical Agitator & Discharge Kit	1/3	.80	26.0	Call
NO P/N-65-CS	I70 (.75) (.625) 1PH 65 Gal. Tank - Mechanical Agitator & Discharge Kit	1/3	1.25	30.5	Call
NO P/N-110-CS	I70 (.75) (.625) 1PH 110 Gal. Tank - Mechanical Agitator & Discharge Kit	1/3	1.25	30.5	Call
NO P/N-65-CS	I70 HVI-88 1PH 65 Gal. Tank - Mechanical Agitator & Discharge Kit	1/3	*.20	*48.0	Call
NO P/N-110-CS	I70 HVI-88 1PH 110 Gal. Tank - Mechanical Agitator & Discharge Kit	1/3	*.20	*48.0	Call
001-215-65-CS	I70 HVI-82 1PH 65 Gal. Tank - Mechanical Agitator & Discharge Kit	1/3	*.20	*75.0	Call
001-215-110-CS	I70 HVI-82 1PH 110 Gal. Tank - Mechanical Agitator & Discharge Kit	1/3	*.20	*75.0	Call
014-011-65-CS	HVI-88 1PH 65 Gal. Tank - Mechanical Agitator & Discharge Kit	1/3	.30	60.0	Call
014-011-110-CS	HVI-88 1PH 110 Gal. Tank - Mechanical Agitator & Discharge Kit	1/3	.30	60.0	Call
007-003-65-CS	HVI-82 1PH 65 Gal. Tank - Mechanical Agitator & Discharge Kit	1/3	5.7	114.0	Call
007-003-110-CS	HVI-82 1PH 110 Gal. Tank - Mechanical Agitator & Discharge Kit	1/3	5.7	114.0	Call



INJECT-O-METER - CHEMIGATION SYSTEM WITH TANK - DUPLEX - 3 PHASE

Part No.	Description	HP	Min. GPH Output	Max. GPH Output	Price
001-204-65-CS	I70 (.75) (.25) 3PH 65 Gal. Tank - Mechanical Agitator & Discharge Kit	1/3	.20	20.0	Call
001-204-110-CS	I70 (.75) (.25) 3PH 110 Gal. Tank - Mechanical Agitator & Discharge Kit	1/3	.20	20.0	Call
001-201-65-CS	I70 (.75) (.375) 3PH 65 Gal. Tank - Mechanical Agitator & Discharge Kit	1/3	.45	22.5	Call
001-201-110-CS	I70 (.75) (.375) 3PH 110 Gal. Tank - Mechanical Agitator & Discharge Kit	1/3	.45	22.5	Call
001-205-65-CS	I70 (.75) (.50) 3PH 65 Gal. Tank - Mechanical Agitator & Discharge Kit	1/3	.8	26.0	Call
001-205-110-CS	I70 (.75) (.50) 3PH 110 Gal. Tank - Mechanical Agitator & Discharge Kit	1/3	.8	26.0	Call
001-202-65-CS	I70 (.75) (.625) 3PH 65 Gal. Tank - Mechanical Agitator & Discharge Kit	1/3	1.25	30.5	Call
001-202-110-CS	I70 (.75) (.625) 3PH 110 Gal. Tank - Mechanical Agitator & Discharge Kit	1/3	1.25	30.5	Call
001-224-65-CS	I70 HVI-88 3PH 65 Gal. Tank - Mechanical Agitator & Discharge Kit	1/3	*.20	*48.0	Call
001-224-110-CS	I70 HVI-88 3PH 110 Gal. Tank - Mechanical Agitator & Discharge Kit	1/3	*.20	*48.0	Call
001-223-65-CS	I70 HVI-82 3PH 65 Gal. Tank - Mechanical Agitator & Discharge Kit	1/3	*.20	*75.0	Call
001-223-110-CS	I70 HVI-82 3PH 110 Gal. Tank - Mechanical Agitator & Discharge Kit	1/3	*.20	*75.0	Call



Note: Minimum GPH output based on simplex operation and max. GPH output based on duplex operation. If you would like assistance in selecting the right pump for your job requirements, please give us a call.

INJECTION EQUIPMENT

POLY TANKS

Clear Tank Part No.	Black Tank Part No.	Gallons	Diameter	Height	Weight	Price
T200VK	T200VBK	200	31"	69"	65 Lbs.	Please Call for Pricing
T300VK	T300VBK	300	56"	34"	90 Lbs.	
T550VK	T550VBK	550	49"	72"	140 Lbs.	
T1000VK	T1000VBK	1000	64"	85"	190 Lbs.	
T1225VK	T1225VBK	1225	87"	54"	185 Lbs.	
T1600VK	T1600VBK	1600	87"	68"	240 Lbs.	
T1750VK	T1750VBK	1750	87"	74"	280 Lbs.	
T2500VK	T2500VBK	2500	96"	91"	425 Lbs.	
T3000VK	T3000VBK	3000	96"	107"	550 Lbs.	



MAZZEI® VENTURI INJECTOR - POLYPROPYLENE

Part No.	Model	Inlet/Outlet	Suction Port	Suction*	Min. Flow*	Price
14000003	484-PP	1/2" MNPT	1/4" MNPT & 1/4" Barb	4 GPH	2.7 GPM	\$86.03
14000006	584-PP	3/4" MNPT	1/4" MNPT & 1/4" Barb	7 GPH	5.0 GPM	\$86.06
14000009	1078-02-PP	1" MNPT	1/2" MNPT & 3/8" Barb	18 GPH	13.7 GPM	\$141.38
14000010	1583A-PP	1-1/2" MNPT	1/2" MNPT & 1/2" Barb	65 GPH	26.9 GPM	\$177.37
14000013	2081A-PP	2" MNPT	1-1/4" MNPT	280 GPH	83.0 GPM	\$248.06

* Suction & flow based on inlet pressure of 35 PSI and outlet pressure of 25 PSI.



MAZZEI® HOOKUP KIT

Part No.	Model	Description	Price
14000403	K184-A	1/2" Injector Kit with Hose, Metering Valve, Strainer, Fittings	\$194.08
14000404	K184-B	3/4" Injector Kit with Hose, Metering Valve, Strainer, Fittings	\$20.36
14000405	K181-A	1" Injector Kit with Hose, Metering Valve, Strainer, Fittings	\$375.30
14000406	K183-A	1-1/2" Injector Kit with Hose, Metering Valve, Strainer, Fittings	\$375.30
14000407	K282-A	2" Injector Kit with Hose, Metering Valve, Strainer, Fittings	\$634.93



POLYPROPYLENE QUICK-ACTING FITTINGS



TYPE A -
Male Adapter x FIPT

Part No.	Size	Price
FS-PP-A050	1/2" x 1/2"	\$2.64
FS-PP-A075	3/4"	\$2.64
FS-PP-A100	1"	\$3.25
FS-PP-A125	1-1/4"	\$4.78
FS-PP-A150	1-1/2"	\$4.98
FS-PP-A200	2"	\$5.99
FS-PP-A300	3"	\$10.61
FS-PP-A400	4"	\$23.48



TYPE B -
Female Coupler x MIPT

Part No.	Size	Price
FS-PP-B050	1/2" x 1/2"	\$8.76
FS-PP-B075	3/4"	\$8.76
FS-PP-B100	1"	\$9.37
FS-PP-B125	1-1/4"	\$13.31
FS-PP-B150	1-1/2"	\$14.37
FS-PP-B200	2"	\$17.24
FS-PP-B300	3"	\$26.46
FS-PP-B400	4"	\$45.35



TYPE C -
Female Coupler x Hose Shank

Part No.	Size	Price
FS-PP-C050	1/2" x 1/2"	\$8.76
FS-PP-C075	3/4"	\$8.76
FS-PP-C100	1"	\$9.57
FS-PP-C125	1-1/4"	\$13.16
FS-PP-C150	1-1/2"	\$14.37
FS-PP-C200	2"	\$17.39
FS-PP-C300	3"	\$26.76
FS-PP-C400	4"	\$46.91



TYPE D -
Female Coupler x FIPT

Part No.	Size	Price
FS-PP-D050	1/2" x 1/2"	\$8.69
FS-PP-D075	3/4"	\$9.08
FS-PP-D100	1"	\$10.14
FS-PP-D125	1-1/4"	\$14.05
FS-PP-D150	1-1/2"	\$15.58
FS-PP-D200	2"	\$17.83
FS-PP-D300	3"	\$28.00
FS-PP-D400	4"	\$49.11



TYPE E -
Male Adapter x Hose Shank

Part No.	Size	Price
FS-PP-E050	1/2" x 1/2"	\$3.06
FS-PP-E075	3/4"	\$3.06
FS-PP-E100	1"	\$3.61
FS-PP-E125	1-1/4"	\$5.16
FS-PP-E150	1-1/2"	\$5.37
FS-PP-E200	2"	\$5.56
FS-PP-E300	3"	\$10.76
FS-PP-E400	4"	\$21.33



TYPE F -
Male Adapter x MIPT

Part No.	Size	Price
FS-PP-F050	1/2" x 1/2"	\$3.06
FS-PP-F075	3/4"	\$3.06
FS-PP-F100	1"	\$3.40
FS-PP-F125	1-1/4"	\$4.82
FS-PP-F150	1-1/2"	\$5.13
FS-PP-F200	2"	\$5.56
FS-PP-F300	3"	\$11.84
FS-PP-F400	4"	\$21.33



TYPE DC -
Dust Cap

Part No.	Size	Price
FS-PP-DC050	1/2" x 1/2"	\$8.76
FS-PP-DC075	3/4"	\$8.76
FS-PP-DC100	1"	\$8.97
FS-PP-DC125	1-1/4"	\$12.54
FS-PP-DC150	1-1/2"	\$13.61
FS-PP-DC200	2"	\$16.79
FS-PP-DC300	3"	\$24.65
FS-PP-DC400	4"	\$40.35



TYPE DP -
Dust Plug

Part No.	Size	Price
FS-PP-DP050	1/2" x 1/2"	\$2.87
FS-PP-DP075	3/4"	\$2.87
FS-PP-DP100	1"	\$3.11
FS-PP-DP125	1-1/4"	\$3.56
FS-PP-DP150	1-1/2"	\$3.77
FS-PP-DP200	2"	\$5.07
FS-PP-DP300	3"	\$9.25
FS-PP-DP400	4"	\$16.00



TYPE D90 -
90° Female Coupler x FIPT

Part No.	Size	Price
PP150D90	1-1/2"	Call
PP200D90	2"	\$26.00



TYPE A90 -
90° Male Adapter x FIPT

Part No.	Size	Price
PP150A90	1-1/2"	\$10.28
PP200A90	2"	\$11.80



TYPE F90 -
90° Male Adapter x MIPT

Part No.	Size	Price
PP150F90	1-1/2"	\$12.41
PP200F90	2"	\$13.16



TYPE C90 -
90° Female Coupler x Hose Shank

Part No.	Size	Price
PP150C90	1-1/2"	\$21.93
PP200C90	2"	\$26.00

DRIP TUBING

JAIN® AQUA-LINE™ PC INLINE EMITTERLINE

Part No.	Model No.	Description	O.D.	I.D.	Weight Lbs.	Price
11500192	A16-2-12PC-500	16mm, 12" Spacing, .5 GPH, 500'	0.633"	0.543"	23	Call
11500119	A16-2-18PC-100	16mm, 18" Spacing, .5 GPH, 100'	0.633"	0.543"	4.3	Call
11500118	A16-2-18PC-100B	16mm, 18" Spacing, .5 GPH, 100' Brown	0.633"	0.543"	4.3	Call
11500116	A16-2-18PC-500B	16mm, 18" Spacing, .5 GPH, 500' Brown	0.633"	0.543"	21.5	Call
11500113	A16-2-24PC-100	16mm, 24" Spacing, .5 GPH, 100'	0.633"	0.543"	4.3	Call
11500112	A16-2-24PC-100B	16mm, 24" Spacing, .5 GPH, 100' Brown	0.633"	0.543"	4.3	Call
11500091	A16-4-12PC-100	16mm, 12" Spacing, 1 GPH, 100'	0.633"	0.543"	4.6	Call
11500090	A16-4-12PC-100B	16mm, 12" Spacing, 1 GPH, 100' Brown	0.633"	0.543"	4.6	Call
11500079	A16-4-12PC-500	16mm, 12" Spacing, 1 GPH, 500'	0.633"	0.543"	21	Call
11500080	A16-4-12PC-500B	16mm, 12" Spacing, 1 GPH, 500' Brown	0.633"	0.543"	21	Call
11500093	A16-4-18PC-100	16mm, 18" Spacing, 1 GPH, 100'	0.633"	0.543"	4.3	Call
11500083	A16-4-18PC-500	16mm, 18" Spacing, 1 GPH, 500'	0.633"	0.543"	21.5	Call
11500084	A16-4-18PC-500B	16mm, 18" Spacing, 1 GPH, 500' Brown	0.633"	0.543"	21.5	Call
11500095	A16-4-24PC-100	16mm, 24" Spacing, 1 GPH, 100'	0.633"	0.543"	4.2	Call
11500088	A16-4-24PC-500B	16mm, 24" Spacing, 1 GPH, 500' Brown	0.633"	0.543"	21	Call
11500265	A18-2-12PC-100	18mm, 12" Spacing, .5 GPH, 100'	0.710"	0.620"	4.6	Call
11500263	A18-2-12PC-500	18mm, 12" Spacing, .5 GPH, 500'	0.710"	0.620"	23	Call
11500261	A18-2-24PC-1000	18mm, 24" Spacing, .5 GPH, 1000'	0.710"	0.620"	42	Call
11500245	A18-2-30PC-1000	18mm, 30" Spacing, .5 GPH, 1000'	0.710"	0.620"	41	Call
11500260	A18-2-36PC-1000	18mm, 36" Spacing, .5 GPH, 1000'	0.710"	0.620"	40	Call
11500267	A18-4-12PC-100	18mm, 12" Spacing, 1 GPH, 100'	0.710"	0.620"	4.6	Call
11500256	A18-4-18PC-1000	18mm, 18" Spacing, 1 GPH, 1000'	0.710"	0.620"	44	Call
11500255	A18-4-24PC-1000	18mm, 24" Spacing, 1 GPH, 1000'	0.710"	0.620"	42	Call
11500239	A18-4-30PC-1000	18mm, 30" Spacing, 1 GPH, 1000'	0.710"	0.620"	41	Call
11500264	A18-4-36PC-1000	18mm, 36" Spacing, 1 GPH, 1000'	0.710"	0.620"	40	Call



MICRO DRIP TUBING

JAIN® / PEPKO™ MINI-PEPLINE™ TF MINI-DRIPPERLINE

Part No.	Model No.	Description	O.D.	I.D.	Carton Qty.	Price
11500023	PM0406100	1/4", 6" Spacing, .5 GPH, 100' Black	0.250"	0.170"	20	Call
11500880	PM0406100B	1/4", 6" Spacing, .5 GPH, 100' Brown	0.250"	0.170"	20	Call
11500025	PM0412100	1/4", 12" Spacing, .5 GPH, 100' Black	0.250"	0.170"	20	Call
11500881	PM0412100B	1/4", 12" Spacing, .5 GPH, 100' Brown	0.250"	0.170"	20	Call

PM0406 MINI-PEPLINE PRECIPITATION RATE FOR GRID PATTERN LAYOUT

Lateral Spacing	Inches / Hour
6"	3.2
9"	2.1
12"	1.6
15"	1.3

PM0412 MINI-PEPLINE PRECIPITATION RATE FOR GRID PATTERN LAYOUT

Lateral Spacing	Inches / Hour
12"	.80
16"	.64
18"	.53
24"	.40
30"	.32
36"	.27



MINI-PEPLINE PRECIPITATION RATES FOR SINGLE LINE LAYOUT (INCHES/HOUR)

Part No.	Sand	Sandy Loam	Loam	Clay Loam	Clay
PM0406	2.4	1.8	1.3	1.1	.9
PM412	1.2	.9	.7	.6	.5

JAIN® (CHAPIN) TWIN-WALL™ DRIP TAPE

BTF 5/8" TWIN-WALL™ DRIP TAPE

Wall thickness available in 4, 5, 6, 8, 10, 12, 15 mil. Common dripper spacing at 6, 8, 12 inch.

Part No.	Diameter	Thickness	Spacing	Reel Length	Price
BTF580412XX-150	5/8"	4 mil	12"	15,000'	Call
BTF580512XX-120	5/8"	5 mil	12"	12,000'	Call
BTF580612XX-100	5/8"	6 mil	12"	10,000'	Call
BTF580812XX-075	5/8"	8 mil	12"	7,500'	Call
BTF581012XX-060	5/8"	10 mil	12"	6,000'	Call
BTF581212XX-050	5/8"	12 mil	12"	5,000'	Call
BTF581512XX-040	5/8"	15 mil	12"	4,000'	Call

Add to Part No. (XX)	Emitter Flow Rate (GPH) at 10 PSI	Spacing	Flow Rate (GPM) per 100 Ft. at 10 PSI
25	0.15	12"	0.25
30	0.18	12"	0.30
40	0.24	12"	0.40
50	0.30	12"	0.50
65	0.39	12"	0.65
85	0.51	12"	0.85
33	0.80	12"	1.33



DELUXE 5/8" TWIN-WALL™ DRIP TAPE

Wall thickness available in 6, 8, 10, 12, 15 mil. Common dripper spacing at 2, 4, 6, 8, 12 inch.

Part No.	Diameter	Thickness	Spacing	Reel Length	Price
DLX580612XX-100	5/8"	6 mil	12"	10,000'	Call
DLX580812XX-075	5/8"	8 mil	12"	7,500'	Call
DLX581008XX-030	5/8"	10 mil	8"	6,000'	Call
DLX581212XX-050	5/8"	12 mil	12"	5,000'	Call
DLX581512XX-040	5/8"	15 mil	12"	4,000'	Call

Add to Part No. (XX)	Emitter Flow Rate (GPH) at 10 PSI	Spacing	Flow Rate (GPM) per 100 Ft. at 10 PSI
25	0.15	12"	0.25
30	0.18	12"	0.30
50	0.30	12"	0.50
65	0.39	12"	0.65
00	0.60	12"	1.00
33	0.80	12"	1.33



MARATHON 7/8" TWIN-WALL™ DRIP TAPE

Wall thickness available in 6, 8, 10, 13, 15 mil. Common dripper spacing at 8, 12 inch.

Part No.	Diameter	Thickness	Spacing	Reel Length	Price
MAR780612XX-075	7/8"	6 mil	12"	7,500'	Call
MAR780812XX-055	7/8"	8 mil	12"	5,500'	Call
MAR781012XX-045	7/8"	10 mil	12"	4,500'	Call
MAR781312XX-035	7/8"	13 mil	12"	3,500'	Call
MAR781512XX-030	7/8"	15 mil	12"	3,000'	Call

Add to Part No. (XX)	Emitter Flow Rate (GPH) at 10 PSI	Spacing	Flow Rate (GPM) per 100 Ft. at 10 PSI
25	0.15	12"	0.25
30	0.18	12"	0.30
40	0.24	12"	0.40



TORO® AG EMITTERS

TURBO-KEY® TURBULENT FLOW EMITTERS

Part No.	Description	Bag Qty.	Price
DNK02-3	0.5 GPH @ 15 PSI	200	\$0.49
DNK04-3	1.0 GPH @ 15 PSI	200	\$0.49
DNK08-3	2.0 GPH @ 15 PSI	200	\$0.49

E-2® TAKE APART EMITTERS

Part No.	Description	Bag Qty.	Price
DBK04	1.0 GPH @ 15 PSI	100	\$0.24
DBK08	2.0 GPH @ 15 PSI	100	\$0.24
DBK16	4.0 GPH @ 15 PSI	100	\$0.24

TURBO-SC® PLUS PRESSURE COMPENSATING EMITTERS

Part No.	Description	Bag Qty.	Price
DPJ02-3	0.5 GPH @ 15-50 PSI	200	\$0.52
DPJ04-3	1.0 GPH @ 10-50 PSI	200	\$0.52
DPJ08-3	2.0 GPH @ 15-45 PSI	200	\$0.52



RAIN BIRD® EMITTERS

SELF PIERCING, USE WITH XM-TOOL TO SPEED INSTALLATION.

LADY BUG TURBULENT FLOW EMITTERS

Part No.	Description	Bag Qty.	Price
EM-L05	Blue, 0.5 GPH @ 15 PSI	250	\$0.35
EM-L10	Black, 1.0 GPH @ 15 PSI	250	\$0.35
EM-L20	Red, 2.0 GPH @ 15 PSI	250	\$0.35

RAIN BUG PRESSURE COMPENSATING EMITTERS

Part No.	Description	Bag Qty.	Price
PCEM10SPB	Black, 1.0 GPH @ 15-50 PSI	250	\$0.41
PCEM20SPB	Red, 2.0 GPH @ 15-50 PSI	250	\$0.41



MICRO SPRINKLER PRODUCTS

RAIN BIRD® MICRO-BIRD® II SPRINKLER (TWO STEP THREAD)

Part No.	Color	Orifice Size	Base Type	Flow (GPH) @ PSI			Bag Qty.	Price
				15	20	25		
SP12-340	Blue	0.039"	5/16" x 32 or 3/16" x 32	10.1	11.6	12.9	200	\$1.65
SP16-340	Green	0.048"		15.1	17.4	19.4	200	\$1.75
SP24-340	Red	0.057"		20.9	24.1	26.9	200	\$1.75
SP30-340	Orange	0.068"		28.9	33.4	37.2	200	\$1.75



TORO® AG MICRO-SPRINKLER® VI CLASSIC

Part No.	Color	Orifice Size	Base Type	Flow (GPH) @ PSI			Bag Qty.	Price
				15	20	25		
SAM610	Black	0.034"	3/8" MIPT	7.9	9.1	10.2	50	\$1.02
SAM613	White	0.041"	3/8" MIPT	11.8	13.7	15.3	50	\$1.02
SAM614	Maroon	0.049"	3/8" MIPT	16.5	19.0	21.2	50	\$1.02
SAM616	Green	0.055"	3/8" MIPT	21.5	24.8	27.8	50	\$1.02
SAM620	Blue	0.065"	3/8" MIPT	29.2	33.7	37.7	50	\$1.02
SAM622	Gray	0.071"	3/8" MIPT	33.8	39.0	43.6	50	\$1.02
SAM624	Yellow	0.079"	3/8" MIPT	41.7	48.1	53.8	50	\$1.02
SAM628	Red	0.091"	3/8" MIPT	56.4	65.1	72.8	50	\$1.02



NELSON R5 ROTATOR® PRODUCTS

The R5 Rotator® is a completely different micro sprinkler, with a unique and patented drive principle. The water stream emitting from the nozzle is directed into an offset channel on the rotor plate, creating a reactionary drive force. A viscous silicone fluid in the rotor motor controls the rotation speed. Rotator® technology gives the R5 high uniformity and a distance of throw greater than that of any other micro sprinkler.



The R5 Rotator® is available with either a standard or flow control nozzle. The flow control nozzle option for the R5 Rotator® features a flow control nozzle that regulates flow starting as low as 15 PSI. Commonly used micro sprinklers with pressure compensation are not recommended for use under 20 PSI. Flow Control Nozzles deliver more accurate flow regulation at lower pressures. Further, they assure uniform application of water throughout the crop.

Always use the recommended pressure for a given plate and nozzle combination. The absence of flow data on the chart below for a particular plate / nozzle combination indicates the pressure is outside the recommended range. Filtration is suggested to be 75 mesh or finer. The plate and nozzle of the R5 should not be removed when cleaning plugged nozzles. Any attempt to do so will likely cause permanent damage. Please give us a call if you have any questions pertaining to the R5.

PLATE / NOZZLE OPTIONS AND FLOW PERFORMANCE IN GPH

Plate Options	Part No.	Recommended Nozzles	PSI					
			15	20	25	30	35	40
<ul style="list-style-type: none"> • Green-Upright Mount • High Pressure Model • Shaded combinations not recommended • Radius 14-17 Ft. 	9836-135	#35 Orange				10.5	11.4	12.1
	9836-140	#40 Blue			12.2	13.3	14.4	15.5
	9836-145	#45 Purple			15.4	16.8	18.2	19.6
	9836-150	#50 Green			18.8	20.6	22.3	23.9
	9836-155	#55 Yellow			22.8	25	27	29
<ul style="list-style-type: none"> • Wine-Inverted Mount • Shaded combinations not recommended • Radius 11-15 Ft. 	9836-235	#35 Orange			9.5	10.5	11.4	12.1
	9836-240	#40 Blue		10.8	12.2	13.3	14.4	15.5
	9836-245	#45 Purple	11.7	13.7	15.4	16.8	18.2	19.6
	9836-250	#50 Green	14.3	16.8	18.8	20.6		
<ul style="list-style-type: none"> • Blue-Upright Mount • Low Pressure Model • Shaded combinations not recommended • Radius 11-16 Ft. 	9836-335	#35 Orange		8.5	9.5	10.5		
	9836-340	#40 Blue	9.3	10.8	12.2	13.3		
	9836-345	#45 Purple	11.7	13.7	15.4	16.8		
	9836-350	#50 Green	14.3	16.8	18.8	20.6		
	9836-355	#55 Yellow	17.4	20.3	22.8			



R5FCN PART NUMBER AND PRESSURE RANGE IN PSI

R5FCN Nozzle Options	Green Plate Part No.	PSI Range	Wine Plate Part No.	PSI Range	Blue Plate Part No.	PSI Range
8.5 GPH Orange	9836-109	-	9836-209	20-45	9836-309	20-40
11 GPH Blue	9836-111	25-45	9836-211	15-45	9836-311	15-40
14 GPH Purple	9836-114	25-45	9836-214	15-45	9836-314	15-35
18 GPH Yellow	9836-118	25-45	9836-218	15-30	9836-318	15-30
24 GPH Red	9836-124	25-45	9836-224	15-25	9836-324	15-30

R5 ROTATOR®

Part No.	Description	Price
Refer to Top Table	R5 Rotator® Including Plate & Standard Nozzle	\$2.86
Refer to Lower Table	R5 Rotator® Including Plate & Flow Control Nozzle	\$3.43

NELSON R5 ROTATOR® FEEDTUBE ASSEMBLIES & ACCESSORIES

Nelson Rotator® Feedtube Assemblies

These versatile stake mounting options feature durable stakes, UV and kink resistant flexible PVC tubing for fast simple installation. Please contact us if you have any questions in regard to these mounting options or any of the following R5 Rotator® accessories.

FT-01 FEEDTUBE ASSEMBLY FOR THE R5 (UPRIGHT MOUNT)

Part No.	Description	Price
10847	Stake 12"	\$0.62
10848	Stake 17-1/2"	\$0.74
9960-924	24" Tube with Barb	\$0.70
9960-930*	30" 4MM Flexible PVC Feedtube & LTO, 4MM Barb Assembly	\$0.82
9960-936	36" Tube with Barb	\$0.96
10745-024	12" Stake & 24" Tube with Barb - Assembled	\$1.31
10745-036	12" Stake & 36" Tube with Barb - Assembled	\$1.57
10744-036	17-1/2" Stake & 36" Tube with Barb - Assembled	\$1.60

* 30" FEEDTUBE NOT AVAILABLE AS STAKE ASSEMBLY

FT-02 FEEDTUBE ASSEMBLY* FOR THE R5 (INVERTED MOUNT)

Part No.	Description	Price
10136	R5 Rod Stake Adapter	\$0.47
9987	Hanger Rod Clip (2 are Required)	
9960-930	30" Tube with Barb	\$0.82
9960-948	48" 4MM Flexible PVC Feed Tube & LTO, 4MM Barb Assembly	
10040-024	24" 6.3MM Fiberglass Plastic Rod Stake	\$1.39
9726-024	24" 6.3MM Steel Rod Stake	

* FOR COMPLETE ASSEMBLY ORDER ADAPTER, 2 CLIPS, FEEDTUBE & STAKE

FT-03 FEEDTUBE ASSEMBLY* FOR THE R5 (UPRIGHT MOUNT)

Part No.	Description	Price
10136	R5 Rod Stake Adapter	\$0.47
9960-924	24" 4MM Flexible PVC Feedtube & LTO, 4MM Barb Assembly	\$0.70
9960-930	30" 4MM Flexible PVC Feedtube & LTO, 4MM Barb Assembly	\$0.82
9960-936	36" 4MM Flexible PVC Feedtube & LTO, 4MM Barb Assembly	\$0.96
10040-018	18" 6.3MM Fiberglass Plastic Rod Stake	
10040-024	24" 6.3MM Fiberglass Plastic Rod Stake	\$1.39
9726-024	24" 6.3MM Steel Rod Stake	\$1.54

* FOR COMPLETE ASSEMBLY ORDER ADAPTER, FEEDTUBE & STAKE

PVC ADAPTER FOR R5 MOUNTING

Part No.	Description	Price
10616	R5 Female Acme x R5 Adapter	\$0.52
10060-001	Male Acme x 1/2" PVC Socket Adapter	\$1.11
10060-002	Male Acme x 3/4" PVC Socket Adapter	\$1.11

STREAM SPLITTERS & DEFLECTOR CAP FOR THE R5

Part No.	Description	Price
10746	Single Sided Stream Splitter for Next to Tree	\$0.62
10976	Two Sided Stream Splitter for Between Trees	\$0.43
10951	Deflector Cap to Reduce Radius to 2-3 Feet	\$0.25

ACCESSORIES FOR THE R5

Part No.	Description	Price
10997	Green Hand Punch Tool, 4MM	\$10.65
10287	FT-03 Stake Installation Tool, 6.3MM Stake	\$9.67
10081-002	4MM Flexible PVC Feedtube, 1000 Ft. Coil	\$150.00
10080	4MM Lateral Take Off (LTO) Barbed Coupling	\$0.12



FOGGERS

TORO® AG BARBED FOGGERS

Part No.	Description	Bag Qty.	Price
SFJ408	1.9 GPH Barbed Fogger	100	\$0.82
SFJ412	3.0 GPH Barbed Fogger	100	\$0.82
SFJ416	3.9 GPH Barbed Fogger	100	\$0.82

TORO® AG THREADED FOGGERS

Part No.	Description	Bag Qty.	Price
SFL408	1.9 GPH Fogger, 1/8" MIPT	100	\$0.90
SFL412	3.0 GPH Fogger, 1/8" MIPT	100	\$0.90
SFL416	3.9 GPH Fogger, 1/8" MIPT	100	\$0.90

TORO® AG THREADED FOGGER WITH STAKE (BARB)

Part No.	Description	Bag Qty.	Price
SFL4081	1.9 GPH Threaded Fogger with Stake	100	\$1.81
SFL4121	3.0 GPH Threaded Fogger with Stake	100	\$1.81
SFL4161	3.9 GPH Threaded Fogger with Stake	100	\$1.81



NURSERY SPRAY STICKS

Used for watering individual pots in Greenhouses and Nurseries.

SWISH STIK™

Part No.	Description	Bag Qty.	Price / Bag
SS-2	SWISH STIK™, Dual Purpose, Single Groove 4.8 GPH, Double Groove 8.4 GPH	100	\$0.12

USE WITH 3/16" (0.125" I.D.) SWISH STIK™ TUBE. SOLD IN BAGS OF 100 ONLY. FLOW SHOWN @ 20 PSI.



SENNINGER® SPRAY STAKES

Part No.	Description	Box Qty.	Price / Bag
SPRST040	Spray Stake, Black, 90°, 4 GPH	1500	\$0.30
SPRST080	Spray Stake, Brown, 120°, 8 GPH	1500	\$0.30
SPRST120	Spray Stake, Green, 160°, 12 GPH	1500	\$0.30

USE WITH 3/16" (0.125" I.D.) SWISH STIK™ TUBE. SOLD IN BOXES OF 1500 ONLY. FLOW SHOWN @ 20 PSI.



NURSERY SPRAY STICKS

Used for watering individual pots in Greenhouses and Nurseries.

MAXI JET MAX-DOUBLE DOWN STREAM

Part No.	Description	Price
RGB36OBU36R1	Complete Assembly, Nursery Clip & 12" Rod	Call
MAU36R1	Blue 3-4 Ft. Diameter @ 20 PSI	Call
MYO	Orange Nursery Clip	Call
MROD12	12" Rod Stake	Call
MOB	Orange Vinyl Collar (Lock Jet Threads into Vinyl)	Call
MJBBXB9	.195" Barb x 195" Barb Extension Adapter	Call
MVU36	36" Blue Vinyl Precut Tubing	Call
MVU500B	500' Blue Vinyl Tubing	Call



JAIN® (CHAPIN) MICRO TUBE & SPRAY TUBE

Part No.	Description	Bag Qty.	Price
12770X18	Standard Tube Weight w/ 18" 128x0XX-PE Tubing	100	Call
12770X36	Standard Tube Weight w/ 36" 128x0XX-PE Tubing	100	Call
12770X48	Standard Tube Weight w/ 48" 128x0XX-PE Tubing	100	Call
12771X18	On/Off Tube Weight w/ 18" 128x0XX-PE Tubing	100	Call
12771X36	On/Off Tube Weight w/ 36" 128x0XX-PE Tubing	100	Call
12771X72	On/Off Tube Weight w/ 72" 128x0XX-PE Tubing	100	Call
12781324	"P" Spray Tube Stake w/ 24" 128x076-PE Tubing - For Pots	100	Call
12783436	"N" Spray Tube Stake w/ 36" 187x125-PE Tubing - For Containers	100	Call



X - USE WITH .128 O.D. X .036, .050, .060, .076 I.D. MICRO TUBE.

PRESSURE REGULATORS

NELSON PRESSURE REGULATORS

Part No.	Description	Flow Range (GPM)	Price
9491-XXX	Blue Top/Gray Lo-Flo 3/4" FIPT	.5 - 10/12	\$11.38
9610-XXX	3/4" FNPT X ACME .5-10	.5 - 10	\$17.32
9561-XXX	Blue Top/Gray Lo-Flo FHT x MHT	.5 - 10/12	\$11.38
9071-XXX	Blue Top/Black Hi-Flo 3/4" FIPT	2 - 16/20	\$17.74



XXX - 10, 15, 20, 25, 30, 40, 50 PSI



SENNINGER® PRESSURE REGULATORS

Part No.	Description	Flow Range (GPM)	Price
PRL-##LF	3/4" FIPT Low Flow	1/2 - 5 & 1/10 - 8	\$11.75
PMR-##MF	3/4" FIPT Medium Flow	4 - 16 & 2 - 20	\$17.00
PR-##HF	1-1/4" FIPT x 1" FIPT High Flow	10 - 32	\$34.00
PRXF-##	3" Socket x Socket	20 - 80/85/90/95/100	\$200.00

- 6, 10, 12, 15, 20, 25, 30, 35, 40, 50, 60 PSI

COMPRESSION FITTINGS

COMPRESSION SIZE SELECTION CHART

Fitting Series Guide	Color of Ends	O.D. Inches	I.D. Inches	O.D. Millimeters	I.D. Millimeters
400	Red	.455	.375	11.6	9.5
600	Green	.620	.520	15.7	13.2
700 / RA440	Black	.685 - .700	.590	17.4 - 17.8	15.0
710	Blue	.700 - .715	.600	17.8 - 18.2	15.2
900 / RA770	Gray / Black	.927	.817	23.5	20.8

COMPRESSION ADAPTER

Part No.	Description	Bag Qty.	Price
12010107	3/8" Comp x 1/2" Spig	100	\$0.35
12010213	16mm Comp x 1/2" Spig	100	\$0.35
12010351	1/2" Comp x 1/2" Spig	100	\$0.35
12010430	18mm Comp x 1/2" Spig	100	\$0.59
12010503	3/4" Comp x 3/4" Spig	50	\$0.59



COMPRESSION X 3/4" FEMALE HOSE SWIVEL COUPLING

Part No.	Description	Bag Qty.	Price
12010233	16mm Comp x 3/4" FHT Swivel, with Washer	25	\$1.46
12010320	1/2" Comp x 3/4" FHT Swivel, with Washer	25	\$1.46
12010372	18mm Comp x 3/4" FHT Swivel, with Washer	25	\$1.46
12010522	3/4" Comp x 3/4" FHT Swivel, with Washer	25	\$2.85



COMPRESSION X 3/4" MALE HOSE THREAD COUPLING

Part No.	Description	Bag Qty.	Price
12010109	3/8" Comp x 3/4" MHT Coupling	25	\$1.42
12010215	16mm Comp x 3/4" MHT Coupling	25	\$0.90
12010303	1/2" Comp x 3/4" MHT Coupling	25	\$0.90
12010354	18mm Comp x 3/4" MHT Coupling	25	\$0.90
12010506	3/4" Comp x 3/4" MHT Coupling	25	\$1.58

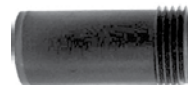

COMPRESSION X 3/4" MALE HOSE THREAD COUPLING WITH CAP

Part No.	Description	Bag Qty.	Price
12010226	16mm Comp x 3/4" MHT Coupling with Cap	25	\$1.42
12010313	1/2" Comp x 3/4" MHT Coupling with Cap	25	\$1.40
12010365	18mm Comp x 3/4" MHT Coupling with Cap	25	\$1.40
12010516	3/4" Comp x 3/4" MHT Coupling with Cap	25	\$2.20



COMPRESSION X 3/4" FEMALE HOSE SWIVEL TEE

Part No.	Description	Bag Qty.	Price
12010244	16mm Comp x 3/4" FHT Swivel, with Washer	25	\$2.04
12010332	1/2" Comp x 3/4" FHT Swivel, with Washer	25	\$2.04
12010384	18mm Comp x 3/4" FHT Swivel, with Washer	25	\$2.04
12010533	3/4" Comp x 3/4" FHT Swivel, with Washer	25	\$4.06



COMPRESSION X 3/4" MALE HOSE THREAD TEE

Part No.	Description	Bag Qty.	Price
12010211	16mm Comp x 3/4" MHT Tee	25	\$2.93
12010297	1/2" Comp x 3/4" MHT Tee	25	\$3.28
12010349	18mm Comp x 3/4" MHT Tee	25	\$3.12
12010501	3/4" Comp x 3/4" MHT Tee	25	\$6.83



COMPRESSION SIZE SELECTION CHART

Fitting Series Guide	Color of Ends	O.D. Inches	I.D. Inches	O.D. Millimeters	I.D. Millimeters
400	Red	.455	.375	11.6	9.5
600	Green	.620	.520	15.7	13.2
700 / RA440	Black	.685 - .700	.590	17.4 - 17.8	15.0
710	Blue	.700 - .715	.600	17.8 - 18.2	15.2
900 / RA770	Gray / Black	.927	.817	23.5	20.8

COMPRESSION COUPLER

Part No.	Description	Bag Qty.	Price
12010108	3/8" Compression Coupler	25	\$0.93
12010214	16mm Compression Coupler	25	\$0.93
12010353	1/2" Compression Coupler	50	\$0.93
12010431	18mm Compression Coupler	25	\$1.26
12010504	3/4" Compression Coupler	25	\$1.26



COMPRESSION ELBOW

Part No.	Description	Bag Qty.	Price
12010220	16mm Compression Elbow	50	\$1.40
12010359	1/2" Compression Elbow	50	\$1.40
12010438	18mm Compression Elbow	25	\$1.98
L770 / 12010511	3/4" Compression Elbow	25	\$1.98



COMPRESSION TEE

Part No.	Description	Bag Qty.	Price
12010210	16mm Compression Tee	50	\$1.40
12010348	1/2" Compression Tee	50	\$1.40
12010426	18mm Compression Tee	25	\$2.88
12010499	3/4" Compression Tee	25	\$2.88



FIGURE 8 END CLOSURE

Part No.	Description	Bag Qty.	Price
12290017	16mm Figure 8 End Closure	100	\$0.23
12290018	1/2" Figure 8 End Closure	100	\$0.30
12290001	1" Figure 8 End Closure	50	



Intro 1 - Pivots 2 - Valves 3 - Surface 4 - IPS Epoxy / Galv. 5 - Suction Fittings 6 - PVC Fittings 7 - Sprinklers 8 - Malleable 9 - Hose 10 - Injectors / Filters 11 - Low Volume Formulas / TC

TAPE-LOC® COUPLING

Part No.	Description	Bag Qty.	Price
12030062	5/8" Tape-Loc Coupling *Orange Ring	50	\$0.80
12030032	7/8" Tape-Loc Coupling *Orange Ring	50	\$1.33



TAPE-LOC® X COMPRESSION

Part No.	Description	Bag Qty.	Price
12030033	5/8" Tape-Loc x 16mm Compression	50	\$1.75
12030041	7/8" Tape-Loc x 16mm Compression	50	\$2.53
12030047	1-3/8" Tape-Loc x 3/4" Compression	25	\$2.53



TAPE-LOC® X SOCKET/SPIGOT

Part No.	Description	Bag Qty.	Price
12030085	5/8" Tape-Loc x 1/2" Soc / 3/4" Spigot	50	\$1.26
12030087	7/8" Tape-Loc x 1/2" Soc / 3/4" Spigot	50	\$1.59
12030088	7/8" Tape-Loc x 3/4" Soc / 1" Spigot	50	\$1.65
12030090	1-3/8" Tape-Loc x 1" Soc / 1-1/4" Spigot	25	\$3.62



TAPE-LOC® X BARB

Part No.	Description	Bag Qty.	Price
12030004	5/8" Tape-Loc x 250 (1/4") Barb	50	\$0.73
12030008	5/8" Tape-Loc x 400 (3/8") Barb	50	\$0.73
12030014	5/8" Tape-Loc x 700 (1/2") Barb	50	\$0.82
12030015	7/8" Tape-Loc x 700 (1/2") Barb	50	\$1.51



TAPE-LOC® X MALE THREAD

Part No.	Description	Bag Qty.	Price
12030076	5/8" Tape-Loc x 1/2" MIPT	50	\$1.09
12030077	7/8" Tape-Loc x 3/4" MIPT	50	\$1.59
12030017	5/8" Tape-Loc x 3/4" MHT	50	\$1.21



TAPE-LOC® X LAY FLAT CONNECTOR

Part No.	Description	Bag Qty.	Price
12030063	5/8" Tape-Loc x Lay Flat	50	\$1.62
12030065	7/8" Tape-Loc x Lay Flat	50	\$2.60



TAPE-LOC® TEE

Part No.	Description	Bag Qty.	Price
12030092	5/8" Tape-Loc Tee	50	\$2.91



TAPE-LOC® X COMPRESSION TEE

Part No.	Description	Bag Qty.	Price
12030100	5/8" Tape-Loc Tee x 16mm Comp. Tee	50	\$2.86



TAPE-LOC® 90° ELBOW

Part No.	Description	Bag Qty.	Price
12030049	5/8" Tape-Loc Elbow	50	\$2.61



JAIN® POLY BARBED & THREADED FITTINGS

JAIN® POLY BARBED & THREADED FITTINGS

Part No.	Description	Bag Qty.	Price
12290075	.375" ID Insert Coupler for 12mm OD Tubing	100	\$0.42
12290078	.520" ID Insert Coupler for 16mm OD Tubing	100	\$0.42
12290082	.620" ID Insert Coupler for 18mm OD Tubing	100	\$0.60
12290085	.710" ID Insert Coupler for 20mm OD Tubing	50	\$0.72
12290077	.375" ID Insert Tee for 12mm OD Tubing	100	\$0.59
12290080	.520" ID Insert Tee for 16mm OD Tubing	100	\$0.66
12290084	.620" ID Insert Tee for 18mm OD Tubing	50	\$0.85
12290087	.710" ID Insert Tee for 20mm OD Tubing	50	\$0.96
12290076	.375" ID Insert Elbow for 12mm OD Tubing	100	\$0.60
12290079	.520" ID Insert Elbow for 16mm OD Tubing	100	\$0.59
12290083	.620" ID Insert Elbow for 18mm OD Tubing	50	\$0.81
12290086	.710" ID Insert Elbow for 20mm OD Tubing	50	\$0.90
12290081	.520" ID Ins. x 3/4" MIPT for 16mm OD Tubing	50	\$0.68



JAIN® / API® CONNECTOR FITTINGS & GROMMETS

JAIN® / API® EPDM PIPE GROMMETS

Part No.	Description	Bag Qty.	Price
12290031	400-GRO For 400 Series Barbs For Min. 1" Diameter PVC Pipe	100	\$0.54
12290032	700-GRO For 700 Series Barbs For Min. 1-1/2" Diameter PVC Pipe	100	\$0.89
12020002	1000-GRO For 1000 Series Barbs For Min. 3" Dia. PVC Pipe	50	\$3.43

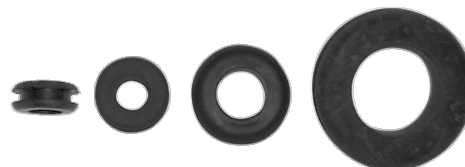

JAIN® / API® CONNECTOR FITTINGS

Part No.	Description	Bag Qty.	Price
12040044	400 Barb x 1/2" Socket / 3/4" Spigot	50	\$0.78
12040045	400 Barb x 1/2" Spigot	50	\$0.78
12040046	400 Barb x 400 Barb Coupling	250	\$0.78
12290036	400 Barbed Plug for 400-GRO	50	\$0.96
12040061	700 Barb x 1/2" Socket / 3/4" Spigot	50	\$0.87
12040092	700 Barb x 3/4" Socket / 1" Spigot	50	\$1.57
12040062	700 Barb x 1/2" Spigot	50	\$0.87
12040063	700 Barb x 700 Barb Coupling	250	\$0.62
12290037	700 Barb Plug for 700-GRO	50	\$1.02
12040006	1000 Barb x 1" Socket / 1-1/4" Spigot	25	\$2.14



OUTLET ADAPTERS

ONE PIECE BONDABLE SADDLE, SOCKET / SPIGOT

Part No.	Description	Bag Qty.	Price
See Below For Part Numbers	1/2" Socket / 3/4" Spigot	25	\$1.26
	3/4" Socket / 1" Spigot	25	\$1.35
	1" Socket / 1 1/4" Spigot	25	\$1.53



Outlet Size	Pipe Size						
Socket / Spigot	1-1/2" Black	2" White	2-1/2" Gray	3" Brown	4" Green	6" Blue	8"-10" Orange
1/2" / 3/4"	12080035	12080036	12080037	12080038	12080039	12080041	---
3/4" / 1"	---	12080049	12080050	12080051	12080052	12080054	12080055
1" / 1-1/4"	---	---	---	---	12080043	12080045	---

USE OF A HEAVY BODIED CEMENT IPS #719 OR EQUIVALENT IS RECOMMENDED. ALWAYS PRIME PIPE AND FITTING.

Intro 1 - Pvcot 2 - Valves 3 - Surface 4 - IPS Epoxy / Galv. 5 - Suction Fittings 6 - PVC Fittings 7 - Sprinklers 8 - Malleable 9 - Hose 10 - Injectors / Filters 11 - Low Volume Formulas / TC

PIVOT DATA FORM

EIS **ESCO** **SWISH** **WISH CO** **WISH NE** **WISH-NW**
 Fax: (352) 472-2830 (806) 747-2706 (254) 968-4075 (303) 364-5055 (402) 549-2183 (208) 232-0694

Dealer Info:

Person Placing Order: _____ PO#: _____ Date: _____
 Sold to: _____ Ship to: _____

Existing System Specifications

Pivot Manufacturer: _____
 Model: _____ Year: _____
 Serial #: _____ Linear: _____ Cornerarm: _____
 Irrigator's Name: _____
 System # or Legal: _____
 Inside Pipe Coating: _____

_____ GPM, _____ PSI at top or end of pivot
 (Circle top or end)

Span	Length	Pipe O.D.	Sprinkler Spacing	Outlets per Span
1				
2				
3				
4				
5				
6				
7				
8				
9				
10				
11				
12				
13				
14				
15				
C				
OH				
Total Length			Total # of Outlets	

Retro Fit Design:

Max Field Elevation: Above _____ Below _____
 Regulators: Manufacturer: _____ Model: _____
 Nominal pressure rating (psi): _____
 Drops: Length or Ground clearance (ft) _____
 Drop pipe nominal diameter (in): _____
 Drop pipe material: _____
 Weights: _____
 Endgun Model: _____
 _____ Endgun Valve: _____ Booster Pump (HP) _____
 _____ Booster at tower with _____ diameter pipe
 Timer @ 100% last tower travels _____ ft/min.
 Motor HP: _____ Motor RPM: _____ Center ratio RPM _____
 Tire size: _____ Wheel gear box ratio: _____

Sprinkler Package:

Sprays:

_____ Nelson D3000 Sprays _____ Concave
 _____ Nelson T3000 Trashbuster _____ Flat
 _____ Senninger LDN Sprays _____ Convex
 _____ Senninger Super Sprays _____ Chemigation
 _____ Senninger LEPA _____ Smooth
 _____ Nelson D3000 Part Circle _____ Deep Groove
 _____ Senninger LDN Part Circle _____ Multi-trajectory
 _____ Senninger Fan Spray
 _____ Hose Drag
 _____ Other

Other Heads:

_____ Nelson R3000 Rotators _____ U4 Blue _____ U6 White _____ D4 Green
 _____ D6 Red _____ D8 Orange _____ D10 Brown
 _____ Nelson TR3000 Trashbuster _____ U4 Blue _____ D4 Green
 _____ Nelson PC R3000 Rotators _____ HF Black _____ LF White
 _____ Nelson S3000 Spinners _____ D6 Red _____ D6 Purple _____ D8 Yellow
 _____ Nelson PC S3000 Spinners
 _____ Nelson A3000 Accelerators
 _____ Nelson N3000 Nutators _____ High Angle Green _____ Low Angle Blue
 _____ Senninger I-Wobs _____ Std Angle Black _____ Low Angle Blue
 _____ Senninger Xi-Wobs _____ 610 Blue _____ 910 Gray _____ 615 Black

Impacts:

_____ RB Standard Brass _____ CDS nozzle _____ Straight Bore
 _____ RB L36H 10° (plastic)
 _____ RB LAPS 10°
 _____ Senninger 6° (plastic) _____ Straight Vane _____ Spiral Vane
 _____ Senninger 12° (plastic)
 _____ Senninger 25° (plastic)
 _____ Nelson F44AAB 8° (plastic) _____ Diffuser nozzle
 _____ Nelson 15° (brass) _____ Flow Control _____ Taper Bore

Ship:

_____ Print Out _____ Sprinklers _____ Regulators _____ Endgun
 _____ Endgun Valve _____ Endgun Nozzle _____ Nozzles Only
 _____ Goosenecks _____ Plugs _____ Drops _____ Weights
 _____ Bushings _____ Couplings _____ Nipples _____ Gauge _____ Clamps
 _____ Other _____

Ship Via:

_____ UPS Regular _____ UPS 2nd Day Air _____ UPS Next Day Air
 _____ UPS Next Day Air Letter _____ Fax _____ Mail _____ Priority Mail
 _____ Express Mail _____ Truck Line _____ Pick Up _____ Email

Special Instructions: _____

DISCHARGE HOSE & CLAMPS CONTINUED

ALFAGOMMA® T253AA 150 PSI

Hose Part No.	Size	Clamp Part No.
T253AA150X100	1-1/2"	94100-0175
T253AA200X100	2"	94100-0238
T253AA250X100	2-1/2"	94100-0275
T253AA300X100	3"	94100-0350
T253AA400X100	4"	95130-0425
T253AA600X100	6"	95130-0625
T253AA662X100	6-5/8"	95130-0706
T253AA800X100	8"	95130-0844
T253AA1000X100	10"	95130-1044
T253AA1200X50	12"	DB1275

NOVAFLEX 2150

Hose Part No.	Size	Clamp Part No.
2150BE-01250-00	1-1/4"	94100-0150
2150BE-01500-00	1-1/2"	94100-0175
2150BE-02000-00	2"	94100-0225
2150BE-00250-00	2-1/2"	94100-0275
2150BE-03000-00	3"	94100-0325
2150BE-03500-00	3-1/2"	94100-0375
2150BE-04000-00	4"	95130-0425
2150BE-05000-00	5"	95130-0525
2150BE-06000-00	6"	95130-0625
2150BE-06250-00	6-5/8"	95130-0706
2150BE-08000-00	8"	95130-0844
2150BE-08625-00	8-5/8"	95130-0918
2150BE-10000-00	10"	95130-1044
2150BE-10750-00	10-3/4"	DB1125
2150BE-12000-00	12"	DB1275
2150BE-12750-00	12-3/4"	DB1360

PLICORD® HD 4 PLY

Hose Part No.	Size	Clamp Part No.
54243712301000	4"	95130-0450
54243713101000	4-1/2"	95130-0500
54243713901000	5"	95130-0550
549806155320	6"	95130-0644
54143716505400	6-5/8"	95130-0725
541806187320	8"	95130-0856
54143719805400	8-5/8"	95130-0918
541806219340	10"	95130-1062
54143725105400	12"	DB1275

SUCTION HOSE & CLAMPS

SPIRAFLEX® 1500

Hose Part No.	Size	Clamp Part No.
58641202401000	3/4"	H1000C
58641203201000	1"	H1600C
58641204001000	1-1/4"	94100-0162
58641204801000	1-1/2"	SDBC-1.5
58641206401000	2"	SDBC-2
58641208001000	2-1/2"	SDBC-2.5
58641210701000	3"	SDBC-3
58641212301000	4"	SDBC-4
58641215501000	6"	SDBC-6
58641218700600	8"	SDBC-8

TIGERFLEX BW "BLUE WATER"

Hose Part No.	Size	Clamp Part No.
BW075X100	3/4"	H1000C
BW100X100	1"	H1600C
BW125X100	1-1/4"	94100-0162
BW150X100	1-1/2"	SDBC-1.5
BW200X100	2"	SDBC-2
BW250X100	2-1/2"	SDBC-2.5
BW300X100	3"	SDBC-3
BW400X100	4"	SDBC-4
BW500X100	5"	SDBC-5
BW600X100	6"	SDBC-6

TIGERFLEX TG "TIGER GREEN"

Hose Part No.	Size	Clamp Part No.
TG200X100	2"	SDBC-2
TG300X100	3"	SDBC-3
TG400X100	4"	SDBC-4
TG600X100	6"	SDBC-6

PLICORD® "CON-AG"

Hose Part No.	Size	Clamp Part No.
54215904001000	1-1/4"	94100-0175
54215904801000	1-1/2"	SDBC-1.5
54215906401000	2"	SDBC-2
54215908001000	2-1/2"	SDBC-2.5
54215910701000	3"	SDBC-3
54215912301000	4"	SDBC-4
54215915501000	6"	SDBC-6

ALFAGOMMA® T202AA/T203AA/T204AA

Hose Part No.	Size	Clamp Part No.
T202AA200X100	2"	DB76
T202AA300X100	3"	DB94
T202AA400X100	4"	DB400
T204AA600X25	6"	DB675
T204AA800X25	8"	DB875
T203AA1000X20	10"	DB1125
T203AA1200X20	12"	DB1275

NUTRIFLO® FOOD TRANSFER

Hose Part No.	Size	Clamp Part No.
58642104801000	1-1/2"	SDBC-1.5
58642106401000	2"	SDBC-2
58642110701000	3"	SDBC-3
58642112301000	4"	SDBC-4

ALFAGOMMA® BLACK PETROLEUM

Hose Part No.	Size	Clamp Part No.
T605AA200X100	2"	SDBC-2
T605AA300X100	3"	SDBC-3

COMMON ABBREVIATIONS

ASTM	=	American Society of Testing Materials
AWWA	=	American Water Works Assn.
CTS	=	Copper Tube Size
DWV	=	Drain, Waste & Vent
FGHT	=	Female Garden Hose Thread
FNPT	=	Female National Pipe Thread
FIPT	=	Femal Iron Pipe Thread
GHT	=	Garden Hose Thread

HDPE	=	High Density Polyethylene
IPS	=	Iron Pipe Size
IPT	=	Iron Pipe Thread
MGHT	=	Male Garden Hose Thread
MIPT	=	Male Iron Pipe Thread
MNPT	=	Male National Pipe Thread
NH	=	National Hose Thread
NPSH	=	National Pipe Straight Hose

NPSM	=	National Pipe Straight Mechanical
NPT	=	National Pipe Tapered
NSF	=	National Sanitation Foundation
NST	=	National Hose Thread also known as National Standard Thread
PIP	=	Plastic Irrigation Pipe
PSI	=	Pounds Per Square Inch

Intro 1 - Pvcot 2 - Valves 3 - Surface 4 - IPS Epoxy / Galv. 5 - Suction Fittings 6 - PVC Fittings 7 - Sprinklers 8 - Malleable 9 - Hose 10 - Injectors / Filters 11 - Low Volume Formulas / TC

TECHNICAL RESOURCES

FLOW	
1 GAL. /MIN.	.002228 CU. FT./SEC
1 GAL. /MIN.	.13368 CU. FT./MIN
1 GAL. /MIN.	8.0208 CU. FT./HR
1 GAL. /MIN.	.0044192 ACRE FT./24 HRS
1 GAL. /MIN.	.06309 LTRS./SEC.
1 GAL. /MIN.	3.78533 LTRS./MIN.
1 CU. FT./SEC	448.83 GPM
1 CU. FT./SEC	.992 ACRE IN./HR
1 CU.FT./SEC	.0283 CU. MTR/SEC.
1 CU. MTR/MIN.	664.2 GPM
1 LTR./SEC	15.852 GPM
1 ACRE IN/HR	452.57 GPM
1 ACRE FT./DAY	226.3 GPM
1 MIL. GAL/DAY	694.4 GPM

VOLUME	
1 OUNCE	16 GRAMS
1 QUART	32 OUNCES
1 QUART	2 PINTS
1 QUART	.9463 LITERS
1 GALLON	4 QUARTS
1 GALLON	.833 IMPERIAL GALLON
1 GALLON	231 CUBIC INCHES
1 GALLON	0.13368 CUBIC METERS
1 GALLON	.00379 CUBIC METERS
1 GALLON	3.7854 LITERS
1 MIL. GAL.	3.06989 ACRE FEET
1 LITER	1.057 QUARTS
1 LITER	2.113 PINTS
1 LITER	.2642 GALLONS
1 LITER	.03501 CUBIC FEET
1 LITER	61.02 CUBIC INCHES
1 ACRE INCH	27,154 GALLONS
1 ACRE FOOT	325,851 GALLONS
1 ACRE FOOT	43,560 CUBIC FEET
1 CUBIC FOOT	1,728 CUBIC INCHES
1 CUBIC FOOT	7.48052 GALLONS
1 CUBIC FOOT	28.32 LITERS
1 CUBIC YARD	27 CUBIC FEET
1 CUBIC YARD	202 GALLONS
1 CUBIC METER	264.2 GALLONS
1 CUBIC METER	1,000 LITERS

AREA	
1 SQ. INCH	6.4516 SQ. CENTM.
1 SQ. FOOT	144 SQ. INCHES
1 SQ. FOOT	.0929 SQ. MTR
1 SQ. YARD	9 SQ. FEET
1 SQ. METER	10.76 SQ. FEET
1 SQ. ROD	272.25 SQ. FEET
1 SQ. ROD	30.25 SQ. YARDS
1 SQ. MILE	640 ACRES
1 SQ. MILE	2.5899 SQ. KILOMETERS
1 ACRE	43,560 SQ FEET
1 ACRE	4,840 SQ. YARDS
1 ACRE	208.7 FT. SQUARE
1 ACRE	160 SQ. RODS
1 ACRE	.405 HECTARES
1 ACRE	.0040469 SQ KILOMETERS
1 SECTION	640 ACRES
1 HECTARE	10,000 SQ. METERS
1 HECTARE	107,639 SQ. FEET
1 HECTARE	11,959.9 SQ. YDS
1 HECTARE	2.4711 ACRES
1 SQ KILOMETER	.3861 SQ MILES
1 SQ KILOMETER	247.104 ACRES

POWER	
1 HORSEPOWER	33,000 FT.LBS./MIN
1 HORSEPOWER	746 WATTS
1 HORSEPOWER	.746 KILOWATTS
1 HORSEPOWER	42.44 BTU/MIN.
1 KILOWATT	56.92 BTU/MIN.
1 KILOWATT	1.341 HORSEPOWER
1 KILOWATT HR.	3,413 BTU

LENGTH	
1 CENTIMETER	.3937 INCHES
1 INCH	2.54 CENTIMETERS
1 CUBIT	18 INCHES
1 FOOT	.3048 METERS
1 METER	39.37 INCHES
1 METER	1.09361 YARDS
1 YARD	.91440 METERS
1 ROD	16.5 FEET
1 ROD	5.5 YARDS
1 CHAIN	4 RODS
1 CHAIN	66 FEET
1 MILE	320 RODS
1 MILE	5,280 FEET
1 MILE	1.609 KILOMETERS
1 KILOMETER	3280.84 FEET
1 KILOMETER	.62137 MILES

WEIGHT	
1 US GALLON WATER	8.3357 LBS.
1 CU. FT. WATER	62.3354 LBS.
1 IMPERIAL GALLON	10.0 LBS.
1 GRAM	.033818 FLUID OUNCES
1 FLUID OUNCE	29.57 GRAMS
1 LITER	2.2 LBS.
1 POUND	16 OUNCES
1 GRAM	.03527 OUNCES
1 OUNCE	28.35 GRAMS
1 KILOGRAM	2.2046 LBS.
EARTH, UNDISTURBED	100 LBS./CU.FT.
CONCRETE (PLAIN)	140 LBS./CU.FT.
CONCRETE (REINF.)	150 LBS./CU.FT.

PRESSURE	
1 PSI	2.309 FT. OF HEAD
1 PSI	144 LBS./SQ.FT.
1 PSI	.06804 ATMOSPHERES
1 PSI	.0689 BARS
1 PSI	6.895 KILOPASCALS
1 PSI	703.1 KG./SQ. MTR.
1 KILOGRAM/SQ. CM.	14.223 PSI
1 ATMOSPHERE	14.6963 PSI
1 ATMOSPHERE	1.033 KG./SQ.CM.
1 BAR	14.50 PSI
1 BAR	2,089 LBS./SQ.FT.
1 BAR	.9869 ATMOSPHERES
1 FT. WATER	.8826 IN. OF MERCURY
1 FT. WATER	304.8 KG./SQ.FT.
1 FT. WATER	.0295 ATMOSPHERES
1 FT. WATER	62.3554 LBS./SQ.FT.
1 FT. WATER	.4335 PSI

VELOCITY	
1 FT./SEC.	.681818 MI./HR.
1 FT./SEC.	.3048 MTR./SEC.
1 FT./SEC.	1.09728 KM./HR.
1 MI./HR.	1.4666 FT./SEC.
1 MI./HR.	.44704 MTR./SEC.
1 MI./HR.	1.609344 KM./HR.
1 MTR./SEC.	3.28084 FT./SEC.
1 MTR./SEC	2.2369 MI./HR.
1 MTR./SEC	3.6 KM./HR.
1 KM./HR	.91134 FT./SEC.
1 KM/ HR	.62137 MI./HR.
1 KM./HR.	.2777 MTR./SEC.

TEMPERATURE CONVERSION

-459° to 0°			1° to 60°			61° to 290°			300° to 890°			900° to 3000°		
C	C F	F	C	C F	F	C	C F	F	C	C F	F	C	C F	F
-273	-459.4		-17.2	1	33.8	16.1	61	141.8	149	300	572	482	900	1652
-268	-450		-16.7	2	35.6	16.7	62	143.6	154	310	590	488	910	1670
-262	-440		-16.1	3	37.4	17.2	63	145.4	160	320	608	493	920	1688
-257	-430		-15.6	4	39.2	17.8	64	147.2	166	330	626	499	930	1706
-251	-420		-15.0	5	41.0	18.3	65	149.0	171	340	644	504	940	1724
-246	-410		-14.4	6	42.8	18.9	66	150.8	177	350	662	510	950	1742
-240	-400		-13.9	7	44.6	19.4	67	152.6	182	360	680	516	960	1760
-234	-390		-13.3	8	46.4	20.0	68	154.4	188	370	698	521	970	1778
-229	-380		-12.8	9	48.2	20.6	69	156.2	193	380	716	527	980	1796
-223	-370		-12.2	10	50.0	21.1	70	158.0	199	390	734	532	990	1814
-218	-360		-11.7	11	51.8	21.7	71	159.8	204	400	752	538	1000	1832
-212	-350		-11.1	12	53.6	22.2	72	161.6	210	410	770	549	1020	1868
-207	-340		-10.6	13	55.4	22.8	73	163.4	216	420	788	560	1040	1904
-201	-330		-10.0	14	57.2	23.3	74	165.2	221	430	806	571	1060	1940
-196	-320		-9.4	15	59.0	23.9	75	167.0	227	440	824	582	1080	1976
-190	-310		-8.9	16	60.8	24.4	76	168.8	232	450	842	593	1100	2012
-184	-300		-8.3	17	62.6	25.0	77	170.6	238	460	860	604	1120	2048
-179	-290		-7.8	18	64.4	25.6	78	172.4	243	470	878	616	1140	2084
-173	-280		-7.2	19	66.2	26.1	79	174.2	249	480	896	627	1160	2120
-169	-273	-459.4	-6.7	20	68.0	26.7	80	176.0	254	490	914	638	1180	2156
-168	-270	-454	-6.1	21	69.8	27.2	81	177.8	260	500	932	649	1200	2192
-162	-260	-436	-5.6	22	71.6	27.8	82	179.6	266	510	950	660	1220	2228
-157	-250	-418	-5.0	23	73.4	28.3	83	181.4	271	520	968	671	1240	2264
-151	-240	-400	-4.4	24	75.2	28.9	84	183.2	277	530	986	682	1260	2300
-146	-230	-382	-3.9	25	77.0	29.4	85	185.0	282	540	1004	693	1280	2336
-140	-220	-364	-3.3	26	78.8	30.0	86	186.8	288	550	1022	704	1300	2372
-134	-210	-346	-2.8	27	80.6	30.6	87	188.6	293	560	1040	732	1350	2462
-129	-200	-328	-2.2	28	82.4	31.1	88	190.4	299	570	1058	760	1400	2552
-123	-190	-310	-1.7	29	84.2	31.7	89	192.2	304	580	1076	788	1450	2642
-118	-180	-292	-1.1	30	86.0	32.2	90	194.0	310	590	1094	816	1500	2732
-112	-170	-274	-0.6	31	87.8	32.8	91	195.8	316	600	1112	843	1550	2822
-107	-160	-256	0.0	32	89.6	33.3	92	197.6	321	610	1130	871	1600	2912
-101	-150	-238	0.6	33	91.4	33.9	93	199.4	327	620	1148	899	1650	3002
-96	-140	-220	1.1	34	93.2	34.4	94	201.2	332	630	1166	927	1700	3092
-90	-130	-202	1.7	35	95.0	35.0	95	203.0	338	640	1184	954	1750	3182
-84	-120	-184	2.2	36	96.8	35.6	96	204.8	343	650	1202	983	1800	3272
-79	-110	-166	2.8	37	98.6	36.1	97	206.6	349	660	1220	1010	1850	3362
-73	-100	-148	3.3	38	100.4	36.7	98	208.4	354	670	1238	1038	1900	3452
-68	-90	-130	3.9	39	102.2	37.2	99	210.2	360	680	1256	1066	1950	3542
-62	-80	-112	4.4	40	104.0	37.8	100	212.0	366	690	1274	1093	2000	3632
-57	-70	-94	5.0	41	105.8	43	110	230	371	700	1292	1121	2050	3722
-51	-60	-76	5.6	42	107.6	49	120	248	377	710	1310	1149	2100	3812
-46	-50	-58	6.1	43	109.4	54	130	266	382	720	1328	1177	2150	3902
-40	-40	-40	6.7	44	111.2	60	140	284	388	730	1346	1204	2200	3992
-34	-30	-22	7.2	45	113.0	66	150	302	393	740	1364	1232	2250	4082
-29	-20	-4	7.8	46	114.8	71	160	320	399	750	1382	1260	2300	4172
-23	-10	14	8.3	47	116.6	77	170	338	404	760	1400	1288	2350	4262
-17.8	0	32	8.9	48	118.4	82	180	356	410	770	1418	1316	2400	4352
			9.4	49	120.2	88	190	374	416	780	1436	1343	2450	4442
			10.0	50	122.0	93	200	392	421	790	1454	1371	2500	4532
			10.6	51	123.8	99	210	410	427	800	1472	1399	2550	4622
			11.1	52	125.6	100	212	413.6	432	810	1490	1427	2600	4712
			11.7	53	127.4	104	220	428	438	820	1508	1454	2650	4802
			12.2	54	129.2	110	230	446	443	830	1526	1482	2700	4892
			12.8	55	131.0	116	240	464	449	840	1544	1510	2750	4982
			13.3	56	132.8	121	250	482	454	850	1562	1538	2800	5072
			13.9	57	134.6	127	260	500	460	860	1580	1566	2850	5162
			14.4	58	136.4	132	270	518	466	870	1598	1593	2900	5252
			15.0	59	138.2	138	280	536	471	880	1616	1621	2950	5342
			15.6	60	140.0	143	290	554	477	890	1634	1649	3000	5432

TECHNICAL RESOURCES

FORMULAS FOR CALCULATING	
VOLUME OF A-	
CUBE	AREA OF BASE x HEIGHT
PYRAMID	1/3 AREA OF BASE x HEIGHT
SPHERE	DIAMETER CUBED x .5236
AREA OF A-	
CIRCLE	RADIUS SQUARED x 3.1416
SQUARE	ONE SIDE SQUARED
TRIANGLE	1/2 BASE x HEIGHT
RECTANGLE	LENGTH x WIDTH
PARALLELOGRAM	BASE x HEIGHT
CIRCUMFERENCE OF A-	
CIRCLE	DIAMETER x 3.1416
ELEVATION VS. PRESSURE	
1 FT. OF RISE OR FALL	= .4335 PSI
1 PSI. OF RISE OR FALL	= 2.309 FT.
FRICITION LOSS FOR 100 FT. OF PIPE (HAZEN-WILLIAMS)	
$F = 0.2086 \left(\frac{100}{C}\right)^{1.85} \times \frac{Q^{1.85}}{D^{4.8655}}$	
WHERE:	
F = PRESSURE LOSS IN FT. OF HEAD/100 FT.	
C = COEFFICIENT OF INSIDE PIPE ROUGHNESS	
Q = FLOW IN GALLONS PER MINUTE	
D = INSIDE PIPE DIAMETER IN INCHES	
TO CONVERT ABOVE INFO. INTO PSI	
$PSI = \frac{F}{2.309}$	
F = Elevation Change (In Feet)	
VELOCITY	
$V = \frac{GPM}{2.45 \times ID^2}$	
WHERE:	
V = VELOCITY IN FEET PER SECOND	
GPM = GALLONS PER MINUTE	
ID = INSIDE PIPE DIAMETER IN INCHES	
POWER	
(BHP) BRAKE HORSE POWER	= $\frac{GPM \times TDH (FT.)}{3960 \times PUMP \text{ EFFICIENCY}}$
PUMP EFFICIENCY	= $\frac{GPM \times TDH (FT.)}{3960 \times BHP \text{ TO PUMP}}$
GPM = GALLONS PER MINUTE	
TDH = TOTAL DYNAMIC HEAD (IN FEET)	
PRECIPITATION RATE	
APPLICATION RATE (INCHES/HOUR)	= $\frac{(GPM/SPKLR.)96.25}{S \times L}$
S = SPKLR. SPACING ALONG LATERALS IN FT.	
L = SPACING BETWEEN LATERALS IN FEET	
NEW NOZZLE FLOWS	
$Q \text{ NEW} = \sqrt{\frac{P \text{ NEW}}{P \text{ OLD}}} \times Q \text{ OLD}$	
WHERE:	
Q = FLOW	P = PSI

FRACTIONS TO DECIMALS TO MILLIMETERS		
Fractions	Decimals	Millimeters
1/64	0.015625	0.397
1/32	0.03125	0.794
3/64	0.046875	1.191
1/16	0.0625	1.588
5/64	0.078125	1.984
3/32	0.09375	2.381
7/64	0.109375	2.778
1/8	0.1250	3.175
9/64	0.140625	3.572
5/32	0.15625	3.969
11/64	0.171875	4.366
3/16	0.1875	4.763
13/64	0.203125	5.159
7/32	0.21875	5.556
15/64	0.234375	5.953
1/4	0.2500	6.350
17/64	0.265625	6.747
9/32	0.28125	7.144
19/64	0.296875	7.541
5/16	0.3125	7.938
21/64	0.328125	8.334
11/32	0.34375	8.731
23/64	0.359375	9.128
3/8	0.3750	9.525
25/64	0.390625	9.922
13/32	0.40625	10.319
27/64	0.421875	10.716
7/16	0.4375	11.113
29/64	0.453125	11.509
15/32	0.46875	11.906
31/64	0.484375	12.303
1/2	0.500	12.700
33/64	0.515625	13.097
17/32	0.53125	13.494
35/64	0.546875	13.891
9/16	0.5625	14.288
37/64	0.578125	14.684
19/32	0.59375	15.081
39/64	0.609375	15.478
5/8	0.6250	15.875
41/64	0.640625	16.272
21/32	0.65625	16.669
43/64	0.671875	17.066
11/16	0.6875	17.463
45/64	0.703125	17.859
23/32	0.71875	18.256
47/64	0.734375	18.653
3/4	0.7500	19.050
49/64	0.765625	19.447
25/32	0.78125	19.844
51/64	0.796875	20.241
13/16	0.8125	20.638
53/64	0.828125	21.034
27/32	0.84375	21.431
55/64	0.859375	21.828
7/8	0.8750	22.225
57/64	0.890625	22.622
29/32	0.90625	23.019
59/64	0.921875	23.416
15/16	0.9375	23.813
61/64	0.953125	24.209
31/32	0.96875	24.606
63/64	0.984375	25.003
1	1.000	25.400

1) 0.001" = 0.0254 mm
1mm = 0.03937"

TO CALCULATE	EQUATION	EXAMPLE
AREA IRRIGATED BY A CENTER PIVOT	$AC = \frac{(PL + EGR)^2}{13866}$ <p>AC = ACRES IRRIGATED PL = PIVOT LENGTH (FT.) EGR = END GUN RADIUS (FT.)</p>	FIND THE ACREAGE IRRIGATED BY A 1000' PIVOT WITH AN END GUN WITH A 130' RADIUS $AC = \frac{(1000 + 130)^2}{13866}$ AC = 92 ACRES
HOURS PER PIVOT REVOLUTION	$HPR = \frac{0.105 (LTD)}{GS}$ <p>HPR = HOURS PER REVOLUTION (HR.) LTD = DISTANCE TO LAST TOWER (FT.) GS = TOWER GROUND SPEED (FT./MIN)</p>	FIND THE AMOUNT OF TIME NEEDED FOR THE PIVOT ABOVE TO COMPLETE A REVOLUTION IF THE LAST TOWER MOVES AT 10.2 FT. PER. MINUTE. THE 1000 FOOT LENGTH INCLUDES A 40 FOOT END BOOM. LTD = 1000 FT. - 40 FT. = 960 FT. $HPR = \frac{0.105(960)}{10.2}$ HPR = 9.9 HOURS PER REVOLUTION
AMOUNT OF WATER APPLIED BY A CENTER PIVOT	$D = \frac{(30.64 Q HPR)}{(PL + EGR)^2}$ <p>D = DEPTH OF WATER APPLIED (IN.) Q = FLOWRATE (GPM) HPR = HOURS PER REVOLUTION (HR.) PL = PIVOT LENGTH (FT.) EGR = END GUN RADIUS (FT.)</p>	DETERMINE THE AMOUNT OF WATER APPLIED FOR THE 1000 FOOT PIVOT CONSIDERED ABOVE AT 700 GPM. $D = \frac{30.64 (700) (9.9)}{(1000 + 130)^2}$ $D = \frac{212,365}{1,276,900}$ D = 0.17 INCH
REQUIRED FLOW FOR A GIVEN PIVOT SPRINKLER	$Q_s = \frac{DFP (Q/AC) SS}{6933}$ <p>Q_s = SPRINKLER FLOWRATE (GPM) DFP = DISTANCE FROM THE PIVOT (FT.) Q = TOTAL PIVOT FLOWRATE (GPM) AC = ACRES IRRIGATED BY PIVOT SS = SPRINKLER SPACING (FT.)</p>	DETERMINE THE FLOWRATE REQUIRED BY A SPRINKLER LOCATED 750 FEET FROM THE PIVOT, IF THE SPRINKLER SPACING AT THAT POINT IS 17 FEET. $Q_s = \frac{(750) (700/92) (17)}{6933}$ $Q_s = \frac{97,011}{6933}$ Q _s = 14.0 GPM
CALCULATING NOZZLE FLOWRATE WITH CHANGING PRESSURE	$Q_1 / Q_2 = (P_1)^{1/2} / (P_2)^{1/2}$ $Q_2 = Q_1 (P_2 / P_1)^{1/2}$ <p>Q₁ = KNOWN NOZZLE FLOW (GPM) Q₂ = NOZZLE FLOW TO DETERMINE (GPM) P₁ = PRESSURE (PSI) FOR Q₁ P₂ = PRESSURE (PSI) FOR Q₂</p>	DETERMINE THE FLOWRATE OF A #30 3TN NOZZLE AT 15 PSI, KNOWING THE FLOW @ 10 PSI IS 4.94 GPM $Q_2 = 4.94 (15/10)^{1/2}$ Q ₂ = 6.05 GPM

NOTE: THE INFORMATION PRINTED ON THIS PAGE IS SUPPLIED COURTESY OF NELSON IRRIGATION CORPORATION, AND HAS BEEN EXTRACTED FROM NELSON'S BROCHURE ENTITLED "CENTER PIVOT SPRINKLER DESIGN - TECHNICAL APPLICATION GUIDE." THIS BROCHURE IS AN EXCELLENT SOURCE MANUAL FOR YOUR SALES PEOPLE. PLEASE LET US KNOW IF YOU NEED ONE.

INDEX

Item	Page
3000 Series Pivot Products	1:18-21
Accelerator	1:20
Blue Top Regulators	1:21, 7:4, 11:10
Drag Hose Adapter	1:18
Rotator®	1:18,19
Spinner	1:18,19
Spray Head	1:18,19
Square Thread x Barb Adapter	1:21
Trash Buster	1:20
485 Micro Strobe Light	1:39
490 Micro Strobe Light	1:39
801 Mini I Strobe Light	1:39
824 Multi Pulse Strobe Light	1:39
A	
A3000 Accelerator	1:20
Actuators, Valve	2:9
Accelerator	1:20
Actuator Rod	1:35
Adapter,	
Adapter, Discharge Threaded x Band & Latch	3:11,38
Adapter, Discharge Threaded, Twist Lock	3:49
Adapter, Eccentric Suction	5:6
Adapter, Flanged Discharge	3:24
Adapter, Vinyl Grommet	1:6
Adapter, Outlet	1:6
Adapter, Suction	5:6
Adapter, Threaded Discharge	3:11,23
Adapter, Twist Lock x Hose	3:22
Quick Disconnect Gun	7:24
Air Release Valve (Air Volume Control)	2:3,4
Air & Vacuum Relief Valves	2:3,4
Air Valves (Snifter)	1:4
Alignment Wire & Accessories	1:38
Aluminum	
Aluminum Band & Latch Fittings	3:37-45
Aluminum Barbed Fittings	3:51
Aluminum Cam Lock Fittings	9:6
Aluminum Ring Lock Fittings	3:46-48
Aluminum Weld on Fittings	3:50,51
Arrestor, Lightening	1:38
B	
Ball Valves	
Ball Valves, Plastic	1:5, 2:12,13
Ball Valves, Brass	2:12
Band, Hold	3:49
Band & Latch	
Band & Latch Couplers, Galvanized	3:6,7
Band & Latch Surface Fittings, Galvanized	3:6
Band & Latch Surface Fittings, Aluminum	3:37-45
Band & Latch, Plug	3:10,41,42
Band & Latch, Reducer	3:10,41
Band & Latch Tee, Galvanized	3:7-9
Band & Latch In Line Tee Valve	3:7,8,45
Barbed Fittings	3:51,52,56
Barbed & Threaded Fittings (for Poly Tube)	11:13
Barbed Steel Hose Mender	9:7
Barbed Steel King Nipple	9:7
Bauer Style Fittings	3:53-56
Big Gun Quick Disconnect Adapters	7:24
Black Weld on Fittings	3:15,17,18
Blocks, Electrical Terminal	1:36
Bolt & Nut Sets	2:10
Bolted Couplings	3:22

Item	Page
Bondable PVC Saddle	1:6, 11:13
Boom Backs, Pivot	1:7
Booster Pump (End Gun)	1:29
Boot Hose, Pivot	1:40
Bullet, Drag (For Pivots)	1:11
Bushings, Malleable Steel	8:7
Butt Weld On Steel Fittings	3:19
Butterfly Valves	2:7-12
C	
Cam Lever	9:5-6 10:15
Cam Lock Fittings	9:5,6
Caps	7:5
Cap, Butt Weld	3:16
Cap, IPS	4:4
Cement PVC	6:18,19
Center Punch Hose Clamp Tool	9:10
Center Drives & Motors (For Pivots)	1:32
Check Valve Flanged Galvanized	3:4,5
Check / Drain Valves	7:3
Check Valve, Wafer	2:14
Chemical & Fertilizer Injectors	10:8-14
Clamps	
Clamps Hose	9:8-11
Clamps, Pipe Repair	4:30,31
Clamps, Pinch	1:13, 9:8
Clamps, Ring Lock	3:48
Clamps, T-Bolt Hose	1:40
Closure Ring, Bauer	3:53,54
Closure Ring, Figure 8	11:11
Collector Ring, Electric	1:38
Compression Fittings (For Poly Tube)	11:10,11
Cones, Weld on Aluminum	3:50
Cones, Butt Weld, Concentric & Eccentric	3:19
Cones, Steel Concentric & Eccentric, Black	3:17
Connector Fittings & Grommeets (Low Pressure)	11:13
Contactors, Electric	1:37
Control Valve, Nelson	1:26, 2:15
Couplers	
Coupler, Aluminum Half	1:14
Couplers, Band & Latch, Aluminum	3:37,38,40 42,43,45
Couplers, Band & Latch, Galvanized	3:6-11
Coupler Bolt Tite	4:20
D	
Disconnect, Electrical Safety	1:3
Discharge	
Discharge Adapter, Flanged	3:24
Discharge Adapter, Threaded	3:11,23,38,49
Discharge Hose	9:2,3
Double Bolt Hose Clamp	9:10
Drain Check Valve	7:3
Drag Bullet	1:10
Drag Socks (For Pivots)	1:10
Drains	1:5
Drive Line Couplings	1:30
Drive Line, Telescoping	1:29
Drip Emitter	11:5
Dripper Line	11:3
Drip Tape	11:4
Drop	
Drop Tube Fittings	1:5
Drop Hose (For Pivots)	1:10
Drop Tubes, Pivots	1:10

INDEX

Item	Page
Drop Tube, Pivot	1:19
Drop Valves	1:5
Drop Weights	1:11
E	
Eccentric Suction Adapter	5:6
Electrical	
Electrical Collector Ring	1:38
Electrical Contactors	1:37
Electrical Fuses	1:33,34
Electrical Micro Switches	1:35
Electrical Relays	1:36
Electrical Safety Switch	1:3
Electrical Transformers	1:35
Elbows	
Elbows, Aluminum Weld On	3:51
Elbows, Band & Latch, Aluminum	3:39
Elbows, Band & Latch, Galvanized	3:9
Elbows, Bauer Style	3:54
Elbows, Black Weld On	3:18
Elbows, Bolt Tite	4:17
Elbows, Butt Weld, Steel	3:19
Elbows, Flanged, Steel	3:25
Elbows, Malleable Steel	8:3-5
Elbows, Pump Suction	5:6
Elbows, Ring Lock	3:20,45
Elbows, Twist Lock	3:49
Elbows, Underground IPS	4:12
Elbows, Valve Opening	3:26-30
Emitters, Drip	11:3
Exhaust Primers	5:3
End Plug Cover, Aluminum, Weld On	3:50
Extensions, Butterfly	2:8
End Flush Kit	1:5
F	
Feed Tube	11:7
Filters	
Filters	10:4-7
Filters, Excluder (For Pivot Drops)	1:5
Filters, Pivot Drop	1:5
Filters, Steel Screen	1:5
Fittings	
Fittings, Band & Latch	3:6-11
Fittings, Drop & Conversion	1:9,10
Fittings, Tape Loc	11:12
Flange	
Flange, Aluminum	3:51
Flange Cross, Steel	3:25
Flanged Gaskets	2:10
Flanged, Reducer, Steel	3:25
Flanges, Sch. 80 PVC	6:15
Flanges, Steel	2:9,10 3:15
Flanged Steel Fittings	3:25
Flow Meters	1:44
Flush Kit, Pivot	1:5
Foggers	11:8
Foot Valves	5:5
Fuses, Electrical	1:33,34
G	
Gaskets	
Gasket, Cross Reference	3:65
Gaskets, (For Aluminum Pipe)	3:57-64
Gaskets, IPS Compression	4:10
Gaskets, Pivot Pipe	1:43
Gaskets, Flange	2:10

Item	Page
Gate Valves	2:14
Gauges, Pressure	1:4
Gear Box, UMC Final Drive	1:31
Goose Necks, Pivot	1:8
Grommet, Outlet Adapter	1:6, 11:13
Grooved Coupling	6:15
Grooved Nipple	6:17
Guidance Cable, Armored Perimeter	1:38
Gun Stands & Carts (For Giant Sprinklers)	7:25
H	
Half Coupler, Aluminum	1:13 3:50
Half Nipple, Aluminum	3:50
Hangers, Support	1:6
Hold Bands	3:49
Hose	9:2,3
Hose Barb, Band & Latch Couplers	3:10
Hose Barb Fittings, Aluminum	3:51
Hose Barb, King Nipples & Menders	9:7
Hose Barb, Steel	3:15,22
Hose Clamps, T-Bolt	1:40
Hose Clamps	9:8-10
Hose, Pivot Boot	1:40
Hose Flexible Drop (For Pivots)	1:10
Hub Towable (For Pivot)	1:30
I	
Inline Universal Tee to Lateral Valve	3:7,37,45,47
Insert Pipe Fittings PVC	6:3,4
Insert Poly Barbed & Threaded Fittings	11:13
Intake Strainers	5:7-10
Injectors, Fertilizer	10:6-14
IPS Underground Fittings	4:4-13
K	
L	
Latch Pocket	3:50
Lay Flat Hose	9:2
Light, Strobe	1:39
Lightening Arrestor	1:38
Line Tee/Field Latch Steel	3:21,37,45,47
Lugs, No Spin (For Pivot Wheels)	1:42
M	
Male End, Weld on Aluminum	3:50
Malleable Steel Fittings	3:8
Manifold Primer	5:4
Mender, Barbed Steel	9:7
Meters, Flow	1:44
Meter Mounting Equipment, Electrical	1:44
Meter, Vanes	1:45
Micro Sprinklers	11:5-7
Micro Sprinkler Stake Assemblies	11:7
Micro Switches	1:35
Micro Tube & Spray Tube	12:10
Motors, Pivot Center Drive	1:32
N	
Nozzle Clip	1:21
O	
Opener, Valve Elbow & Tee	3:26-31
P	
Pinch Clamp	1:14 9:8
Pinch Clamp Tools	1:14 9:8
Pipe Fittings	
Pipe Fittings, Insert PVC	6:3,4
Pipe Fittings, Malleable	8:3-8

INDEX

Item	Page
Pipe Fittings, Sch. 80 PVC	6:11-15
Pipe Fittings, Sch. 40 PVC	6:5-10
Pivot	
Pivot Booster Pump	1:29
Pivot Boot Hose	1:40
Pivot End Gun Valves	1:28
Pivot End Gun Valves Parts	1:29
Pivot Pipe Gasket	1:38
Pivot Sprinklers	1:16-22
Pitot Tube	1:4
Pivot Drains	1:5
Pivot Drop Tubes	1:10
Pivot Flush Kit	1:6
Pivot Goosenecks	1:9
Plastic Drop Tubes (For Pivots)	1:10
Plastic Goose Necks (For Pivots)	1:9
Plugs, Band & Latch	3:10,41,42,43
Plugs	
Plugs, IPS	4:10
Plugs, Ring Lock	3:21,48
Plugs, Malleable Steel	8:8
Plugs, Merchant Fittings	8:9
Plug, Surge Ring Lock	3:48
Plugs, Twist Lock	3:49
Polypropylene Cam Lock Fittings	9:5 10:15
Poly Barbed & Threaded Fittings	11:13
Poly Tube Compression Fittings	11:10,11
Power Primers	5:4
Pressure Gauge & Accessories	1:5
Pressure Regulators	1:21 11:9
Pressure Relief Valve	2:5,6
Pressure Switch, (For Pivots)	1:35
Primers (For PVC Pipe)	6:19
Priming Pumps	5:3
Pump	
Pump Discharge Adapters	3:23,24
Pump, Priming	5:3,4
Pump Accessories	1:29
Pump, Booster	1:29
Pump Suction Fittings	3:11
Q	
Quick Acting Fittings	9:5,6
Quick Disconnect 1/4" FIPT	1:5
Quick Disconnect Big Gun Adapters	7:24
R	
Rectifier	1:38
Reducer	
Reducer, Band & Latch	3:10,41
Reducer, Flanged Concentric Steel	3:25
Reducer, Hose x Twist Lock, Galvanized	3:21
Reducer, Ring Lock	3:20,48
Reducer, Underground IPS	4:9
Regulators, Plastic	1:14,21 7:3,4
Relays, Electrical	1:36
Relief, Air & Vacuum Valves	2:3,4
Relief Valve Brass	2:5,6
Relief Valve, Pressure	2:3-6
Repair Coupler, Bolt Tite	4:21-23
Repair Coupling, IPS	4:11
Repair Sleeve	3:49
Ring, Figure 8 Closure	11:11
Ring Lock Clamps	3:48
Ring Lock Surface Fittings, Aluminum	3:46-48

Item	Page
Ring Lock Surface Fittings, Galv. & Black Steel	3:12-16,20,21
Riser, Cap & Tee, IPS	4:4-8,15
Riser Coupler, Bolt Tite	4:18
S	
Saddles, With Bales	1:43
Saddles, PVC Bondable	1:6 11:13
Safety Switch, Electrical	1:3
Sand Separators	10:7
Sealing Ring, Bauer	3:53
Separators, Sand	10:7
Service Tee, IPS	4:8
Screen Filters	10:4-7
Screen, Footvalve	5:5
Screen, Galvanized	10:4
Screen, Self Cleaning	5:11
Sleeve, Repair	3:49
Socks, Drag (for Pivots)	1:10
Spray Sticks	11:8,9
Spin Lock Fittings (For Poly Pipe)	11:11
Spiral Hose Clamp	9:10
Sprinklers	7:5-20
Sprinkler Gun Stands & Carts	7:25
Sprinkler, Micro	11:6
Sprinkler, Pivot	1:15-21,23-26
Stake Assembly, (For Micro Sprinklers)	11:7
Steel Butt Weld Fittings	3:19
Steel Cones, Concentric & Eccentric	3:17
Steel Flanged Cross	3:25
Steel Elbows, Black Weld On	3:18
Steel Fittings, Flanged, Galvanized	3:25
Steel Fittings, Malleable	8:3-8
Steel Flanges	2:10 3:15
Steel Nipples	8:9-11
Strainers, Intake, Pump	5:7-10
Strobe Lights	1:39
Support Hangers	1:7
Suction Fittings	5:6
Suction Hose	9:3,4
Suction Primers	5:3,4
Sweep, IPS Weld On	4:9
Switch, Electrical Safety	1:3,35
Switch, Limit	1:35
Switch, Micro	1:35
Switch, Pressure	1:35
T	
Tape, Drip	11:4
Tape Loc Fittings	11:12
Tee, Band & Latch, Aluminum	3:37,39
Tee, Aluminum Weld On	3:51
Tee, Black Weld On	3:18
Tee, Band & Latch Galvanized	3:7-9
Tee, Bauer	3:55
Tee, Bolt Tite	4:19
Tee, Butt Weld, Steel	3:19
Tee, Flanged Steel	3:25
Tee, Malleable Steel	8:3
Tee, Ring Lock, Galvanized	3:21
Tee Risers, IPS	4:4-7,16
Tee Riser, Saddle Type	4:16
Tee, Service, IPS	4:8,15-16
Tee, Twist Lock	3:49
Tee, Underground, IPS	4:15
Tee, Valve Band & Latch, Aluminum	3:47
Tee, Valve, Ring Lock In Line, Aluminum	3:47

INDEX

Item	Page
Timers, Percentage & Over Watering (For Pivots)	1:35
Tires, New & Recapped	1:44,45
Tool, Center Punch Clamp	9:10
Too, Pinch Clamp	1:14
Tool, Stake Installation	11:7
Too, 4MM Tube Punch	11:7
Transformers, Electrical	1:35
Tri Pod Gun Mount	7:25
Tube, Micro & Spray	11:9
Tubes, Tire	1:41
Twist Lock x Hose Adapters	3:22
Twist Lock Fittings	3:49
Two Wheel Gun Carts	7:25
U	
Underground IPS Fittings	4:4-24
Unions, Malleable Steel	8:8
Universal Mainline Tee To Lateral Valve	3:7,8,20,37,47
Universal Valve Openers	3:26,27
Undersling	1:7
V	
Valve, Actuators	2:9
Valve, Air Relief	2:3,4
Valve, Brass Ball	2:12
Valve, Plastic Ball	1:6 2:12,13
Valve, Butterfly	2:7-12
Valve, Flanged Check & Chemigation	3:4,5
Valve, Nelson Control	2:15
Valve, Wafer Check	2:14
Valve, Control	1:26,27
Valve, Drain (Bleeder Orifice)	1:6 3:5
Valve, Check	2:14 3:4,5
Valve, Foot	5:5
Valve, Gate	2:14
Vanes, Flow Meter	1:45
Valve Opening Elbows	3:26-30
Valve, Pressure Relief	2:5,6
Valve, Snifter (Schrader)	1:4
Valve, Stub	3:32-34
Valve, Stub Parts	3:35,36
Valve, Ring Lock Tee To Lateral	3:20,47
Valve, Vacuum & Air Release	2:3,4
Victolic Grooved Coupler	6:17 8:9
W	
Water Meters	1:44-45
Weights, Drop	1:11
Weld On Butt Weld Steel Fittings	3:19
Weld On Band & Latch Couplers, Galvanized	3:10
Weld On Fittings, Aluminum	3:37,40,45,46,50,51
Weld On Fittings, Black	3:15-18
Weld On IPS Sweep	3:10,13-19
Wheel Gear Box, UMC	1:31
Wire Hose Clamp	9:8
Worm Gear Hose Clamp	9:8
Z	
Z Pipes, IPS	4:3

2020 Irrigation Catalog



5328 N.W. SR 45
Post Office Box 1089
Newberry, Florida 32669

Ph: 352-472-3323

Fax: 352-472-2830

EIS@irrigationdistributors.com

Visit Us Online @
www.IrrigationDistributors.com



Your **1** Stop Source
For All Your Irrigation Needs